

TOSHIBA

E15-007

Leading Innovation >>>

Model name:

MMY-MAP_6HT8P

MMY-MAP_6HT7P

SMMS
SUPER MODULAR MULTI SYSTEM



**Engineering
Data Book**

< Full version >



Notice: Toshiba is committed to continuously improving its products to ensure the highest quality and reliability standards, and to meet local regulations and market requirements. All features and specifications are subject to change without prior notice.









Safety caution	2
1 System overview	5
1-1. Allocation standard of model name	5
1-2. Summary of system equipments	6
2 Equipment selection procedure	11
2-1. Selection flow chart.....	11
2-2. Combination conditions for indoor unit and outdoor unit	12
2-3. Cooling/heating capacity characteristics.....	12
2-4. Operational temperature range.....	18
3 Refrigerant piping design.....	19
3-1. Free branching system	19
3-2. Allowable length/height difference of refrigerant piping	20
3-3. Selection of refrigerant piping	21
3-4. Charging requirement with additional refrigerant	22
4 Wiring design	23
4-1. General	23
4-2. Summary of wiring design	23
4-3. Electrical wiring design	23
4-4. Outdoor unit power supply.....	24
4-5. Indoor unit power supply.....	27
4-6. Design of control wiring	32
5 Outdoor unit.....	34
5-1. Specifications.....	34
5-2. Dimensional drawing	56
5-3. Center of gravity.....	84
5-4. Branch header / Branch joint.....	86
5-5. Refrigerant cycle diagram.....	89
5-6. Wiring diagram.....	92
5-7. Connecting diagram.....	98
5-8. Applied control for Outdoor Unit	104
5-9. Optional printed circuit board (PCB) of outdoor unit.....	107
5-10. Part load performance.....	116
5-11. Sound pressure level data.....	186
Appendix.....	195



- Before use, read carefully through the “Safety caution” section to ensure correct operation.
- The important contents concerned to the safety are described in the “Safety cautions”. Be sure to keep them. For Indications and their meanings, see the following description.

■ Warning Indications on the Air Conditioner Unit

Warning indication		Description
	<p>WARNING</p> <p>ELECTRICAL SHOCK HAZARD Disconnect all remote electric power supplies</p>	<p>WARNING</p> <p>ELECTRICAL SHOCK HAZARD Disconnect all remote electric power supplies before servicing.</p>
	<p>WARNING</p> <p>Moving parts. Do not operate unit with grille removed.</p>	<p>WARNING</p> <p>Moving parts. Do not operate unit with grille removed. Stop the unit before the servicing.</p>
	<p>CAUTION</p> <p>High temperature parts. You might get burned when removing this panel.</p>	<p>CAUTION</p> <p>High temperature parts. You might get burned when removing this panel.</p>
	<p>CAUTION</p> <p>Do not touch the aluminum fins of the unit. Doing so may result in injury.</p>	<p>CAUTION</p> <p>Do not touch the aluminium fins of the unit. Doing so may result in injury.</p>
	<p>CAUTION</p> <p>BURST HAZARD Open the service valves before the operation,</p>	<p>CAUTION</p> <p>BURST HAZARD Open the service valves before the operation, otherwise there might be the burst.</p>
	<p>CAUTION</p> <p>Do not climb onto the fan guard. Doing so may result in</p>	<p>CAUTION</p> <p>Do not climb onto the fan guard. Doing so may result in injury.</p>



■ Explanation of indications

⚠ WARNING

Indicates possibilities that a death or serious injury of personnel is caused by an incorrect handling.

⚠ CAUTION

Indicates contents that an injury (*1) or property damage (*2) only may be caused when an incorrect work has been executed.

*1: "Injury" means a hurt, a burn, or an electric shock which does not require hospitalization or a long-term going to the hospital.

*2: "Property damage means an enlarged damage concerned to property, or breakage of materials.

- **After installation work has finished, check there is no trouble by a test operation, and explain using method and maintenance method to the customers based on the Owner's Manual.**

Please ask the customers to keep this Installation Manual together with the Owner's Manual.

⚠ WARNING

Ask a shop or a professional dealer to install the air conditioner.

If you will install by yourself, a fire, an electric shock, or water leak is caused.

Take measures so that the refrigerant does not exceed the limit concentration even if it leaks when installing the air conditioner in a small room.

For the measures not to exceed the limit of concentration, contact the dealer. If the refrigerant leaks and it exceeds the limit of concentration, an accident of oxygen shortage is caused.

Install the air conditioner at a place which is satisfactorily bearable to weight.

If strength is insufficient, the unit may fall down resulting in human injury.

Perform a specified installation work against a strong wind such as typhoon or earthquake.

If the air conditioner is imperfectly installed, an accident by falling or dropping may be caused.

If refrigerant gas leaks during installation work, ventilate the room.

If the leaked refrigerant gas approaches to fire, noxious gas may generate.

After installation work, confirm that refrigerant gas does not leak.

If refrigerant gas leaks in the room, and approaches to fire such as fan heater, stove or kitchen range, generation of noxious gas may be caused.

Never recover refrigerant in the outdoor unit.

Be sure to use a refrigerant recovery device to recover refrigerant in reinstallation or repair work.

Recovery of refrigerant in the outdoor unit is unavailable; otherwise a serious accident such as crack or human injury is caused.

A person qualified for the electric work should deal with the electric construction conforming to the regulations of the local electric company and the Installation Manual. Be sure to use the exclusive circuit.

If there is capacity shortage of the power supply circuit or incomplete installation, a fire or an electric shock is caused.

For cabling, use the specified cables and connect them securely so that external force of cable does not transmit to the terminal connecting section.

If connection or fixing is incomplete, a fire, etc. may be caused.

Be sure to connect earth wire.

Do not connect earth wire to gas pipe, water pipe, lightning rod, nor earth wire of telephone.

If grounding is incomplete, an electric shock is caused.

⚠ CAUTION

Do not install the air conditioner at a place where combustible gas may leak.

If gas leaks and is collected at surrounding the unit, the production of fire may be caused.

Be sure to attach an earth leakage breaker; otherwise an electric shock may be caused.

Using a torque wrench, tighten the flare nut in the specified method.

If the flare nut is exceedingly tightened, the flare nut is broken and a refrigerant leakage may be caused after a long time has passed.

WARNINGS ON REFRIGERANT LEAKAGE

Check of Concentration Limit

The room in which the air conditioner is to be installed requires a design that in the event of refrigerant gas leaking out, its concentration will not exceed a set limit.

The refrigerant R410A which is used in the air conditioner is safe, without the toxicity or combustibility of ammonia, and is not restricted by laws to be imposed which protect the ozone layer. However, since it contains more than air, it poses the risk of suffocation if its concentration should rise excessively.

Suffocation from leakage of R410A is almost nonexistent. With the recent increase in the number of high concentration buildings, however, the installation of multi air conditioner systems is on the increase because of the need for effective use of floor space, individual control, energy conservation by curtailing heat and carrying power etc.

Most importantly, the multi air conditioner system is able to replenish a large amount of refrigerant compared with conventional individual air conditioners. If a single unit of the multi conditioner system is to be installed in a small room, select a suitable model and installation procedure so that if the refrigerant accidentally leaks out, its concentration does not reach the limit (and in the event of an emergency, measures can be made before injury can occur).

In a room where the concentration may exceed the limit, create an opening with adjacent rooms, or install mechanical ventilation combined with a gas leak detection device.

The concentration is as given below.

$$\frac{\text{Total amount of refrigerant (kg)}}{\text{Min. volume of the indoor unit installed room (m}^3\text{)}} \leq \text{Concentration limit (kg/m}^3\text{)}$$

Concentration limit

Compliance to the local applicable regulations and standards for the concentration limit is required.

NOTE 1:

If there are 2 or more refrigerating systems in a single refrigerating device, the amounts of refrigerant should be as charged in each independent device.

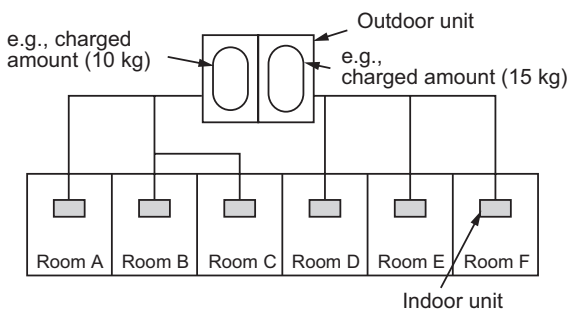

For the amount of charge in this example:

The possible amount of leaked refrigerant gas in rooms A, B and C is 10 kg.

The possible amount of leaked refrigerant gas in rooms D, E and F is 15 kg.

Important

NOTE 2:

The standards for minimum room volume are as follows.

- (1) No partition (shaded portion)

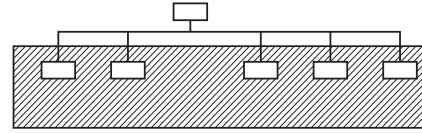

- (2) When there is an effective opening with the adjacent room for ventilation of leaking refrigerant gas (opening without a door, or an opening 0.15 % or larger than the respective floor spaces at the top or bottom of the door).

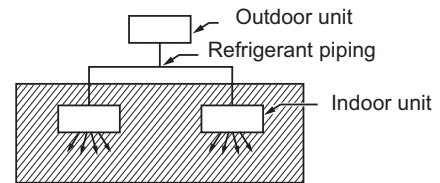

- (3) If an indoor unit is installed in each partitioned room and the refrigerant tubing is interconnected, the smallest room of course becomes the object. But when a mechanical ventilation is installed interlocked with a gas leakage detector in the smallest room where the density limit is exceeded, the volume of the next smallest room becomes the object.

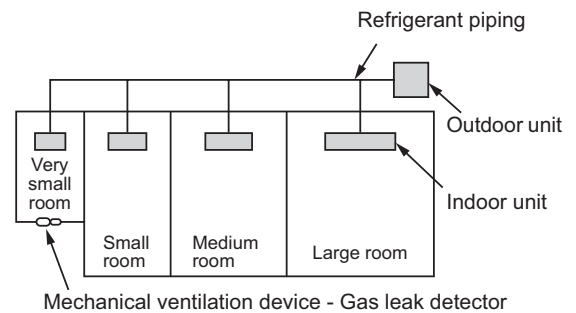



1-1. Allocation standard of model name SMMS-e

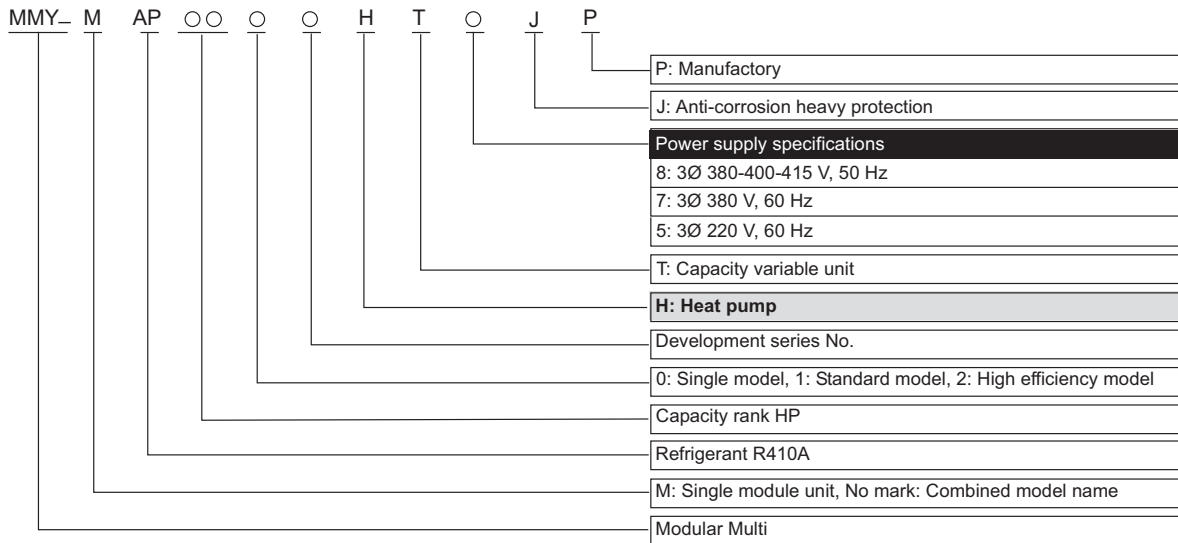



1-2. Summary of system equipments Equipment

1-2-1. Outdoor units

Corresponding HP		Inverter unit								
		8HP	10HP	12HP	14HP	16HP	18HP	20HP	22HP	
Model name	Heat pump	MMY-	MAP0806HT8P	MAP1006HT8P	MAP1206HT8P	MAP1406HT8P	MAP1606HT8P	MAP1806HT8P	MAP2006HT8P	MAP2206HT8P
		MMY-	MAP0806HT7P	MAP1006HT7P	MAP1206HT7P	MAP1406HT7P	MAP1606HT7P	MAP1806HT7P	MAP2006HT7P	MAP2206HT7P
Cooling capacity (kW)			22.4	28.0	33.5	40.0	45.0	50.4	56.0	61.5
Heating capacity (kW)			25.0	31.5	37.5	45.0	50.0	56.0	63.0	64.0
No. of connectable indoor units			13	16	20	23	27	30	33	37

■ Combination of outdoor units

Standard model

Corresponding HP		24HP	26HP	28HP	30HP	32HP	34HP	36HP	38HP
Combined Model	MMY-	AP2416HT8P	AP2616HT8P	AP2816HT8P	AP3016HT8P	AP3216HT8P	AP3416HT8P	AP3616HT8P	AP3816HT8P
	MMY-	AP2416HT7P	AP2616HT7P	AP2816HT7P	AP3016HT7P	AP3216HT7P	AP3416HT7P	AP3616HT7P	AP3816HT7P
Cooling capacity (kW)		67.0	73.5	78.5	85.0	90.0	95.4	101.0	106.5
Heating capacity (kW)		75.0	82.5	87.5	95.0	100.0	106.0	113.0	114.0
Combined outdoor units		12HP	14HP	16HP	16HP	16HP	18HP	20HP	22HP
		12HP	12HP	12HP	14HP	16HP	16HP	16HP	16HP
		-	-	-	-	-	-	-	-
No. of connectable indoor units		40	43	47	50	54	57	60	64

Corresponding HP		40HP	42HP	44HP	46HP	48HP	50HP	52HP	54HP
Combined Model	MMY-	AP4016HT8P	AP4216HT8P	AP4416HT8P	AP4616HT8P	AP4816HT8P	AP5016HT8P	AP5216HT8P	AP5416HT8P
	MMY-	AP4016HT7P	AP4216HT7P	AP4416HT7P	AP4616HT7P	AP4816HT7P	AP5016HT7P	AP5216HT7P	AP5416HT7P
Cooling capacity (kW)		112.0	117.5	123.0	130.0	135.0	140.4	146.0	151.5
Heating capacity (kW)		126.0	127.0	128.0	145.0	150.0	156.0	163.0	164.0
Combined outdoor units		20HP	22HP	22HP	16HP	16HP	18HP	20HP	22HP
		20HP	20HP	22HP	16HP	16HP	16HP	16HP	16HP
		-	-	-	14HP	16HP	16HP	16HP	16HP
No. of connectable indoor units		64	64	64	64	64	64	64	64

Corresponding HP		56HP	58HP	60HP
Combined Model	MMY-	AP5616HT8P	AP5816HT8P	AP6016HT8P
	MMY-	AP5616HT7P	AP5816HT7P	AP6016HT7P
Cooling capacity (kW)		157.0	162.5	168.0
Heating capacity (kW)		176.0	177.0	178.0
Combined outdoor units		20HP	22HP	22HP
		20HP	20HP	22HP
		16HP	16HP	16HP
No. of connectable indoor units		64	64	64

High efficiency / Heating capacity priority model

Corresponding HP		20HP	22HP	36HP	38HP	40HP	42HP	44HP	54HP
Combined Model	MMY-	AP2026HT8P	AP2226HT8P	AP3626HT8P	AP3826HT8P	AP4026HT8P	AP4226HT8P	AP4426HT8P	AP5426HT8P
	MMY-	AP2026HT7P	AP2226HT7P	AP3626HT7P	AP3826HT7P	AP4026HT7P	AP4226HT7P	AP4426HT7P	AP5426HT7P
Cooling capacity (kW)		56.0	61.5	100.5	107.0	113.5	120.0	125.0	152.0
Heating capacity (kW)		63.0	69.0	112.5	120.0	127.5	135.0	140.0	171.0
Combined outdoor units		10HP	12HP	12HP	14HP	14HP	14HP	16HP	20HP
		10HP	10HP	12HP	12HP	14HP	14HP	14HP	20HP
		-	-	12HP	12HP	12HP	14HP	14HP	14HP
No. of connectable indoor units		33	37	60	64	64	64	64	64





1-2-2. Indoor unit

Type	Appearance	Model name	Capacity rank	Capacity code	Cooling capacity (kW)	Heating capacity (kW)
4-way Air Discharge Cassette Type		MMU-AP0094HP-E	009 type	1.00	2.8	3.2
		MMU-AP0124HP-E	012 type	1.25	3.6	4.0
		MMU-AP0154HP-E	015 type	1.70	4.5	5.0
		MMU-AP0184HP-E	018 type	2.00	5.6	6.3
		MMU-AP0244HP-E	024 type	2.50	7.1	8.0
		MMU-AP0274HP-E	027 type	3.00	8.0	9.0
		MMU-AP0304HP-E	030 type	3.20	9.0	10.0
		MMU-AP0364HP-E	036 type	4.00	11.2	12.5
		MMU-AP0484HP-E	048 type	5.00	14.0	16.0
		MMU-AP0564HP-E	056 type	6.00	16.0	18.0
Compact 4-way Cassette (600 x 600) Type		MMU-AP0074MH-E	007 type	0.80	2.2	2.5
		MMU-AP0094MH-E	009 type	1.00	2.8	3.2
		MMU-AP0124MH-E	012 type	1.25	3.6	4.0
		MMU-AP0154MH-E	015 type	1.70	4.5	5.0
		MMU-AP0184MH-E	018 type	2.00	5.6	6.3
2-way Air Discharge Cassette Type		MMU-AP0072WH	007 type	0.80	2.2	2.5
		MMU-AP0092WH	009 type	1.00	2.8	3.2
		MMU-AP0122WH	012 type	1.25	3.6	4.0
		MMU-AP0152WH	015 type	1.70	4.5	5.0
		MMU-AP0182WH	018 type	2.00	5.6	6.3
		MMU-AP0242WH	024 type	2.50	7.1	8.0
		MMU-AP0272WH	027 type	3.00	8.0	9.0
		MMU-AP0302WH	030 type	3.20	9.0	10.0
		MMU-AP0362WH	036 type	4.00	11.2	12.5
		MMU-AP0482WH	048 type	5.00	14.0	16.0
1-way Air Discharge Cassette Type		MMU-AP0074YH-E	007 type	0.80	2.2	2.5
		MMU-AP0094YH-E	009 type	1.00	2.8	3.2
		MMU-AP0124YH-E	012 type	1.25	3.6	4.0
		MMU-AP0154SH-E	015 type	1.70	4.5	5.0
		MMU-AP0184SH-E	018 type	2.00	5.6	6.3
		MMU-AP0244SH-E	024 type	2.50	7.1	8.0
Concealed Duct Type		MMD-AP0076BHP-E	007 type	0.80	2.2	2.5
		MMD-AP0096BHP-E	009 type	1.00	2.8	3.2
		MMD-AP0126BHP-E	012 type	1.25	3.6	4.0
		MMD-AP0156BHP-E	015 type	1.70	4.5	5.0
		MMD-AP0186BHP-E	018 type	2.00	5.6	6.3
		MMD-AP0246BHP-E	024 type	2.50	7.1	8.0
		MMD-AP0276BHP-E	027 type	3.00	8.0	9.0
		MMD-AP0306BHP-E	030 type	3.20	9.0	10.0
		MMD-AP0366BHP-E	036 type	4.00	11.2	12.5
		MMD-AP0486BHP-E	048 type	5.00	14.0	16.0
Concealed Duct High Static Pressure Type		MMD-AP0186HP-E	018 type	2.00	5.6	6.3
		MMD-AP0246HP-E	024 type	2.50	7.1	8.0
		MMD-AP0276HP-E	027 type	3.00	8.0	9.0
		MMD-AP0366HP-E	036 type	4.00	11.2	10.0
		MMD-AP0486HP-E	048 type	5.00	14.0	16.0
		MMD-AP0566HP-E	056 type	6.00	16.0	18.0
		MMD-AP0724H-E	072 type	8.00	22.4	25.0
		MMD-AP0964H-E	096 type	10.00	28.0	31.5



Type	Appearance	Model name	Capacity rank	Capacity code	Cooling capacity (kW)	Heating capacity (kW)
Slim Duct Type		MMD-AP0074SPH-E	007 type	0.80	2.2	2.5
		MMD-AP0094SPH-E	009 type	1.00	2.8	3.2
		MMD-AP0124SPH-E	012 type	1.25	3.6	4.0
		MMD-AP0154SPH-E	015 type	1.70	4.5	5.0
		MMD-AP0184SPH-E	018 type	2.00	5.6	6.3
		MMD-AP0244SPH-E	024 type	2.50	7.1	8.0
Ceiling Type		MMC-AP0157HP-E	015 type	1.70	4.5	5.0
		MMC-AP0187HP-E	018 type	2.00	5.6	6.3
		MMC-AP0247HP-E	024 type	2.50	7.1	8.0
		MMC-AP0277HP-E	027 type	3.00	8.0	9.0
		MMC-AP0367HP-E	036 type	4.00	11.2	12.5
		MMC-AP0487HP-E	048 type	5.00	14.0	16.0
High-wall Type 3 series		MMK-AP0073H	007 type	0.80	2.2	2.5
		MMK-AP0093H	009 type	1.00	2.8	3.2
		MMK-AP0123H	012 type	1.25	3.6	4.0
		MMK-AP0153H	015 type	1.70	4.5	5.0
		MMK-AP0183H	018 type	2.00	5.6	6.3
		MMK-AP0243H	024 type	2.50	7.1	8.0
Floor Standing Concealed Type		MML-AP0074BH-E	007 type	0.80	2.2	2.5
		MML-AP0094BH-E	009 type	1.00	2.8	3.2
		MML-AP0124BH-E	012 type	1.25	3.6	4.0
		MML-AP0154BH-E	015 type	1.70	4.5	5.0
		MML-AP0184BH-E	018 type	2.00	5.6	6.3
		MML-AP0244BH-E	024 type	2.50	7.1	8.0
Floor Standing Cabinet Type		MML-AP0074H-E	007 type	0.80	2.2	2.5
		MML-AP0094H-E	009 type	1.00	2.8	3.2
		MML-AP0124H-E	012 type	1.25	3.6	4.0
		MML-AP0154H-E	015 type	1.70	4.5	5.0
		MML-AP0184H-E	018 type	2.00	5.6	6.3
		MML-AP0244H-E	024 type	2.50	7.1	8.0
Console Type		MML-AP0074NH-E	007 type	0.80	2.2	2.5
		MML-AP0094NH-E	009 type	1.00	2.8	3.2
		MML-AP0124NH-E	012 type	1.25	3.6	4.0
		MML-AP0154NH-E	015 type	1.70	4.5	5.0
		MML-AP0184NH-E	018 type	2.00	5.6	6.3
Floor Standing Type		MMF-AP0156H-E	015 type	1.70	4.5	5.0
		MMF-AP0186H-E	018 type	2.00	5.6	6.3
		MMF-AP0246H-E	024 type	2.50	7.1	8.0
		MMF-AP0276H-E	027 type	3.00	8.0	9.0
		MMF-AP0366H-E	036 type	4.00	11.2	10.0
		MMF-AP0486H-E	048 type	5.00	14.0	16.0
		MMF-AP0566H-E	056 type	6.00	16.0	18.0
		MMF-AP0723DH-V	072 type	8.00	22.4	25.0
Large Capacity Floor Standing Type		MMF-AP0963DH-V	096 type	10.00	28.0	31.5
		MMF-AP1443DH-V	114 type	16.00	45.0	50.0
		MMF-AP1923DH-V	192 type	20.00	56.0	63.0
		MMF-AP0723H-VA	072 type	8.00	22.4	25.0
		MMF-AP0963H-VA	096 type	10.00	28.0	31.5
		MMF-AP1443H-VA	114 type	16.00	45.0	50.0
		MMF-AP1923H-VA	192 type	20.00	56.0	63.0
		MMF-AP0723H-VB	072 type	8.00	22.4	25.0
		MMF-AP0963H-VB	096 type	10.00	28.0	31.5
		MMF-AP1443H-VB	114 type	16.00	45.0	50.0
MMF-AP1923H-VB	192 type	20.00	56.0	63.0		

1-2-3. Branching joints and headers

Name	Model name	Appearance
Y-shape branching joint	RBM-BY55E	
	RBM-BY105E	
	RBM-BY205E	
	RBM-BY305E	
4-branching header	RBM-HY1043E	
	RBM-HY2043E	
8-branching header	RBM-HY1083E	
	RBM-HY2083E	
Branching joint for connection of outdoor units	RBM-BT14E	
	RBM-BT24E	

1-2-4. Remote controllers

Name	Model Name	Remarks
Wired remote controller	RBC-AMT32E	
Simple wired remote controller	RBC-AS21E2, RBC-AS41E	
Wireless remote controller kit	RBC-AX32U(W)-E RBC-AX32U(WS)-E	For 4-way Air Discharge Cassette
	RBC-AX32CE2	For Under Ceiling, 1-way Air Discharge Cassette SH
	TCB-AX32E2	For Compact 4-way Cassette, 1-way Air Discharge Cassette YH, Concealed Duct Standard, Slim Duct, Floor Standing Cabinet, Floor Standing
	RBC-AX23UW(W)-E	For 2-way Air Discharge Cassette
ON-OFF controller	TCB-CC163TLE2	
Central remote controller	BMS-CM1280TLE	
Schedule timer	TCB-EXS21TLE	
Remote controller with schedule timer (7-day timer function)	RBC-AMS41E	
Lite-Vision plus Remote Controller	RBC-AMS51E-EN/ES	-EN : English, Italian, Polish, Greece, Russian, Turkish -ES : English, Spanish, Portuguese, French, Dutch, German
Wired remote controller for Air to Air Heat Exchanger with DX coil unit	NRC-01HE	For Air to Air Heat Exchanger with DX coil type

1-2-5. Optional PCB of outdoor unit

Name	Model Name	Remarks
Power peak-cut control board	TCB-PCDM4E	
External master ON/OFF control board	TCB-PCMO4E	
Output control board	TCB-PCIN4E	



1-2-6. Controls

Name	Model Name	Remarks
Touch Screen Controller	BMS-TP0641ACE BMS-TP5121ACE BMS-TP0641PWE BMS-TP5121PWE	ACE: Without energy monitoring function PWE:With energy monitoring function 0641:Maximum 64 indoor units connectable 5121:Maximum 512 indoor units connectable
	BMS-CT5120E	
Smart BMS manager	BMS-SM1280HTLE	
Smart BMS manager with data analyzer	BMS-SM1280ETLE	
WEB Based Controller	BMS-WB2561PWE	
	BMS-WB01GTE	
TCS-NET Relay Interface	BMS-IFLSV4E	
Energy Monitoring Relay Interface	BMS-IFWH5E	
Digital I/O Relay Interface	BMS-IFDD03E	
LonWorks LN Interface	TCB-IFLN642TLE	
BACnet Server	BMS-LSV9E	
	BMS-STBN10E	
Modbus Interface	TCB-IFMB641TLE	
Analog Interface	TCB-IFCB640TLE	



2-1. Selection flow chart

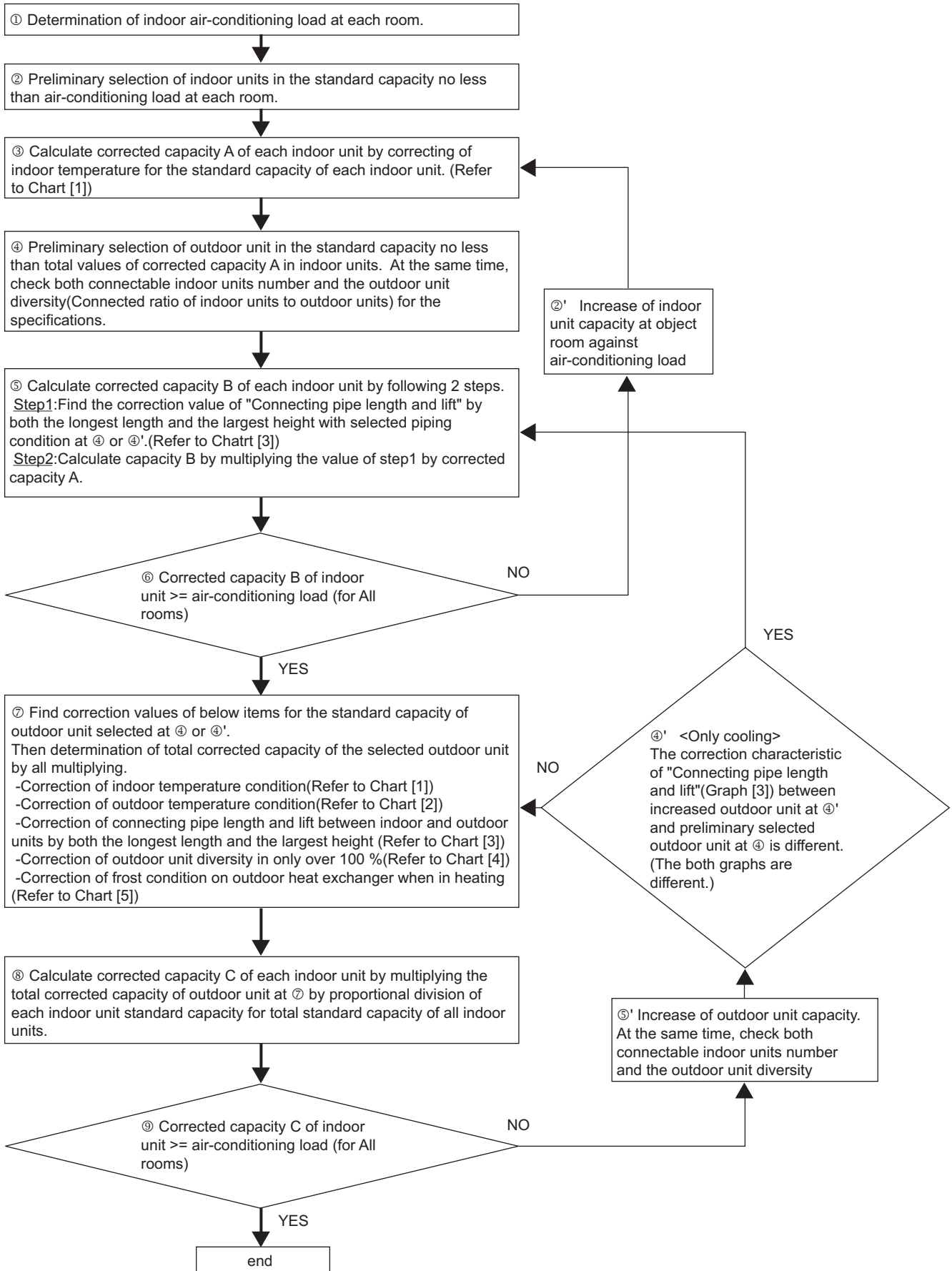

2-2. Combination conditions for indoor unit and outdoor unit

Indoor unit can connect 50 % to 135 % of Outdoor unit capacity.

NOTE:

Height difference between indoor unit over 15 m, combination conditions for indoor and outdoor unit is 50 % to 105 %.

For the fresh air intake units, up to 2 units for one system and also within 30% to capacity of the connectable indoor air conditioners are allowed.

2-3. Cooling/heating capacity characteristics

2-3-1. Correction charts for cooling capacity calculation

[1] Indoor air wet bulb temperature vs. capacity correction value

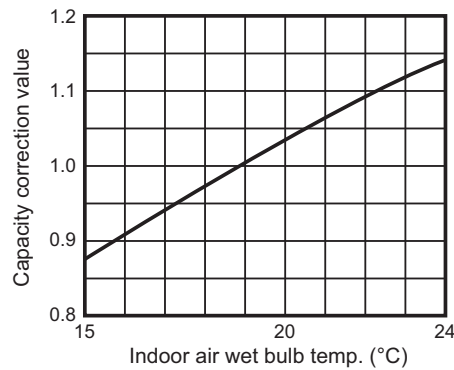

[2] Outdoor air dry bulb temperature vs. capacity correction value

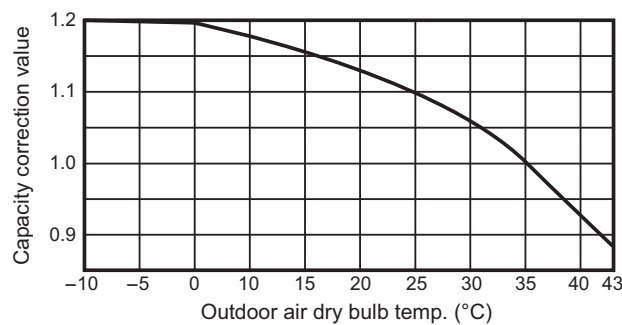

[3] Connecting pipe length and lift difference between indoor and outdoor units vs. capacity correction value

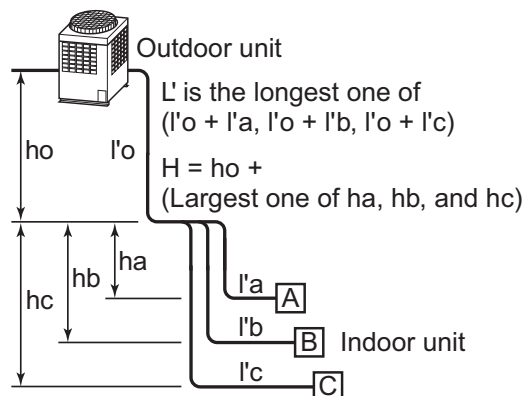

HP	Graph	standard		high efficiency	
		combination	Pipe length [m]	combination	Pipe length [m]
8	D	8	210		
10	C	10	210		
12	A	12	210		
14	A	14	210		
16	B	16	210		
18	C	18	210		
20	C	20	210	10+10	220
22	C	22	210	12+10	220
24	A	12+12	220		
26	B	14+12	220		
28	B	16+12	220		
30	B	16+14	220		
32	C	16+16	220		
34	C	18+16	220		
36	A	20+16	220	12+12+12	235
38	A	22+16	220	14+12+12	235
40	B	20+20	220	14+14+12	235
42	B	22+20	220	14+14+14	235
44	B	22+22	220	16+14+14	235
46	B	16+16+14	185		
48	C	16+16+16	185		
50	C	18+16+16	185		
52	C	20+16+16	185		
54	E	22+16+16	185	20+20+14	185
56	E	20+20+16	185		
58	E	22+20+16	185		
60	E	22+22+16	185		

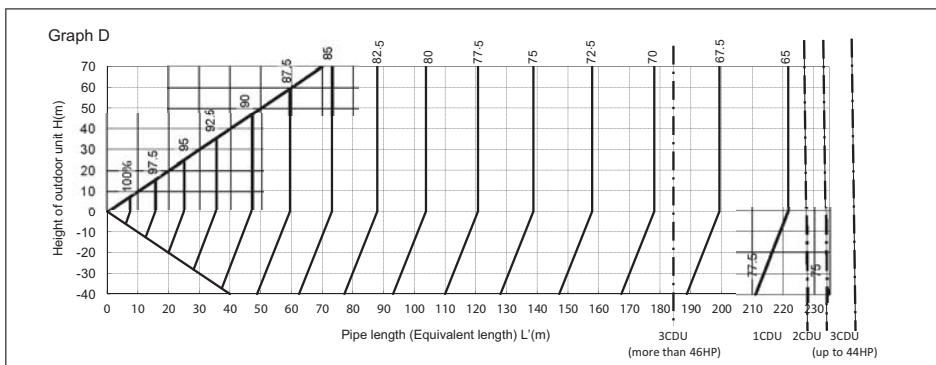
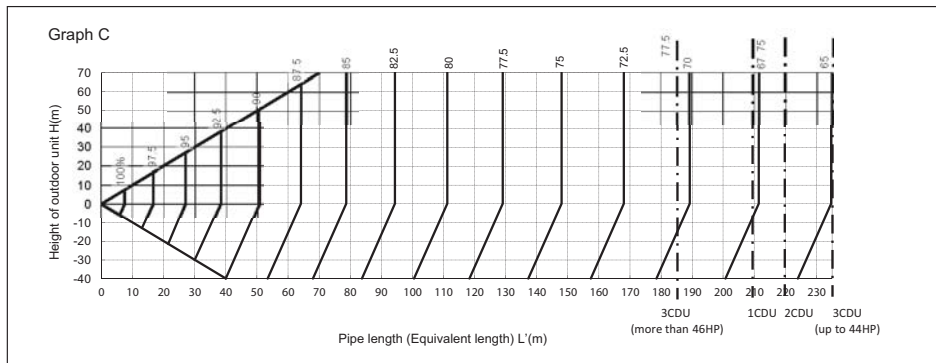
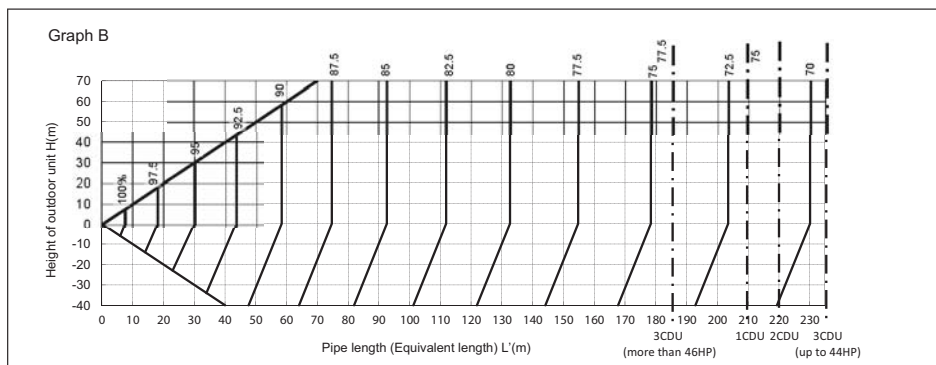
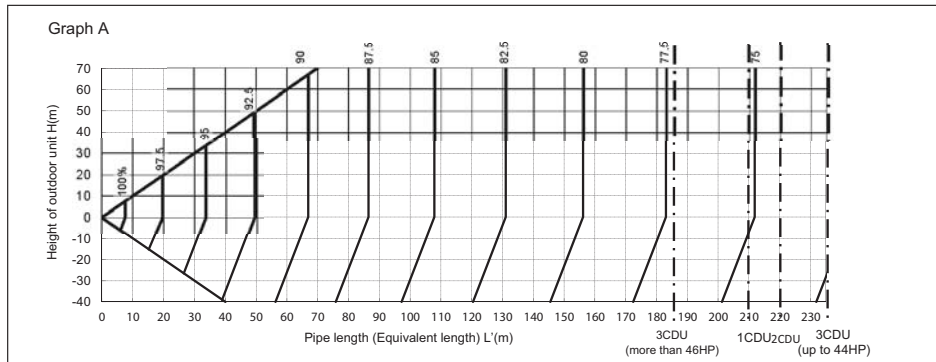

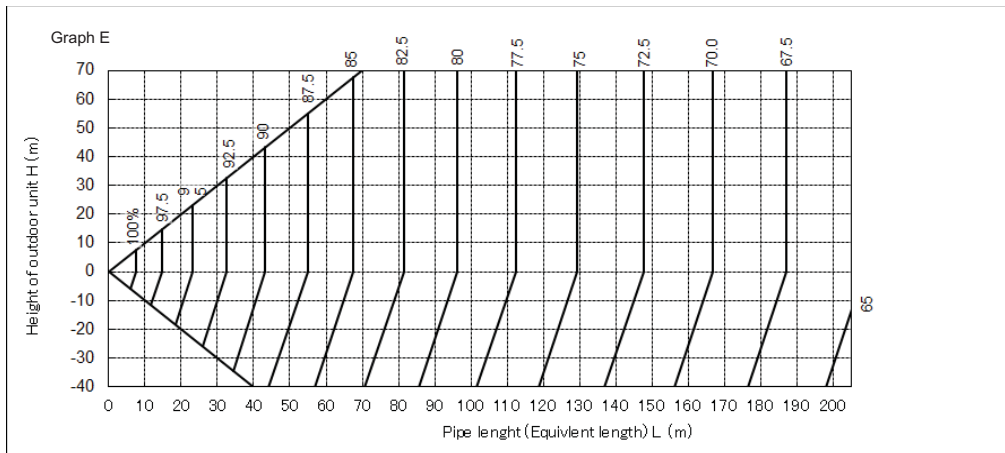

[4]* Correction of outdoor unit diversity

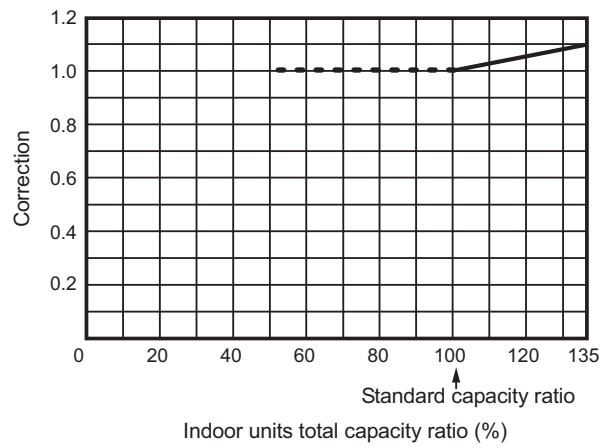

*: Coefficient to use for the correction of the outdoor unit capacity when the total capacity of the indoor units are not equal to the outdoor unit capacity.



2-3-2. Correction charts for heating capacity calculation

[1] Indoor air dry bulb temperature vs. capacity correction value

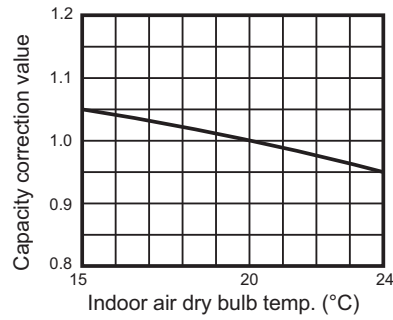

[2] Outdoor air wet bulb temperature vs. capacity correction value

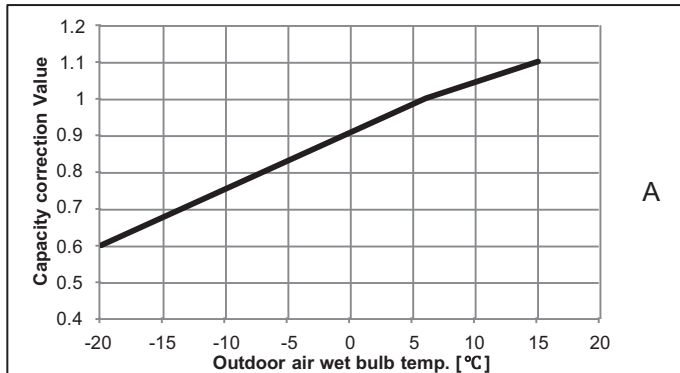

A

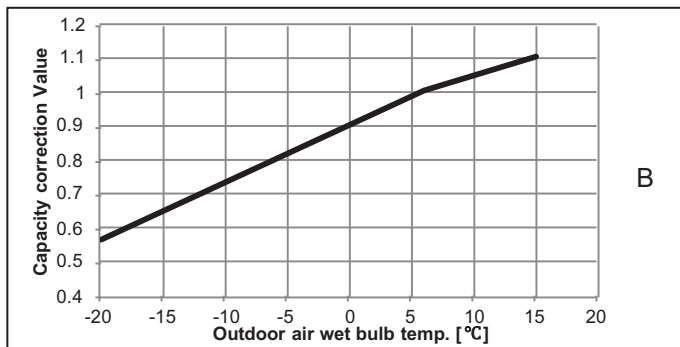

B

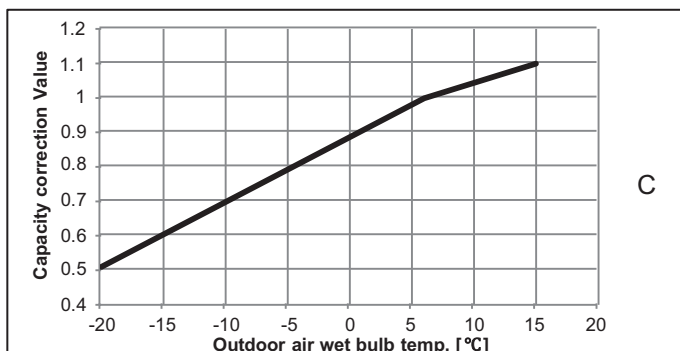

C

Standard model

HP	combination	Graph
8	8	A
10	10	B
12	12	C
14	14	B
16	16	C
18	18	B
20	20	C
22	22	C
24	12+12	C
26	14+12	C
28	16+12	C
30	16+14	C
32	16+16	C
34	18+16	C
36	20+16	C
38	22+16	C
40	20+20	C
42	22+20	C
44	22+22	C
46	16+16+14	C
48	16+16+16	C
50	18+16+16	C
52	20+16+16	C
54	22+16+16	C
56	20+20+16	C
58	22+20+16	C
60	22+22+16	C

High efficiency model

HP	combination	Graph
20	10+10	B
22	12+10	C
36	12+12+12	C
38	14+12+12	C
40	14+14+12	B
42	14+14+14	B
44	16+14+14	B



2-3-2. Correction charts for heating capacity calculation

[3] Connecting pipe length and lift difference between indoor and outdoor units vs. capacity correction value

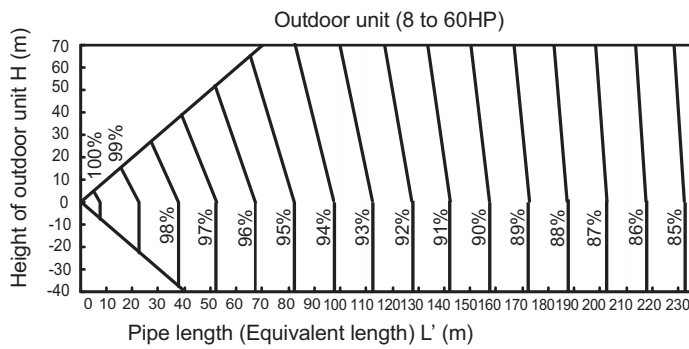
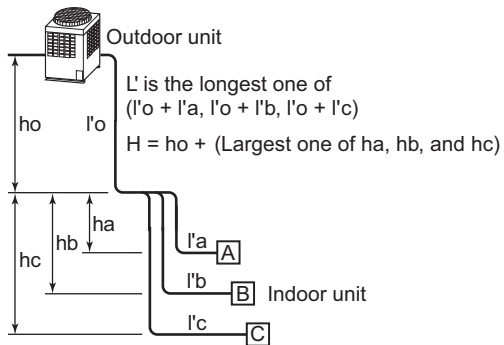



[4]* Correction of outdoor unit diversity

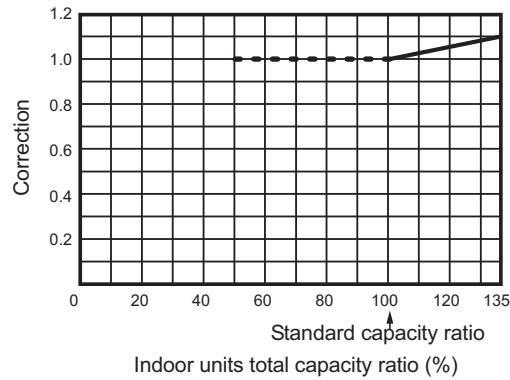

*: Coefficient to use for the correction of the outdoor unit capacity when the total capacity of the indoor units are not equal to the outdoor unit capacity.

2-3-3. Capacity correction in case of frost on the outdoor heat exchanger when in heating

Correct the heating capacity when frost can be found on the outdoor heat exchanger.

Heating capacity = Capacity after correction of outdoor unit x Correction value of capacity resulted from frost
 (Capacity after correction of outdoor unit: Heating capacity calculated in the above item 2.)

[5] Capacity correction in case of frost on the outdoor heat exchanger

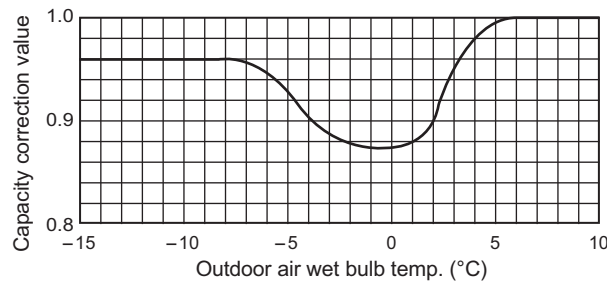

2-3-4. Rated conditions

Cooling: Indoor air temperature 27 °C DB / 19 °C WB, Outdoor air temperature 35 °C DB

Heating: Indoor air temperature 20 °C DB, Outdoor air temperature 7 °C DB / 6 °C WB

2-4. Operational temperature range

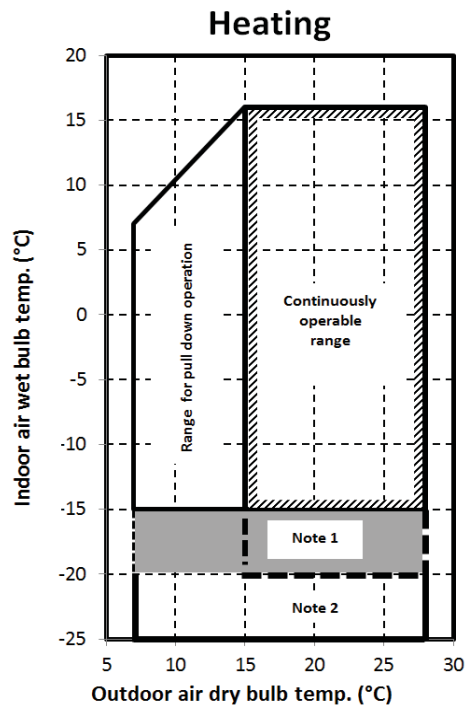
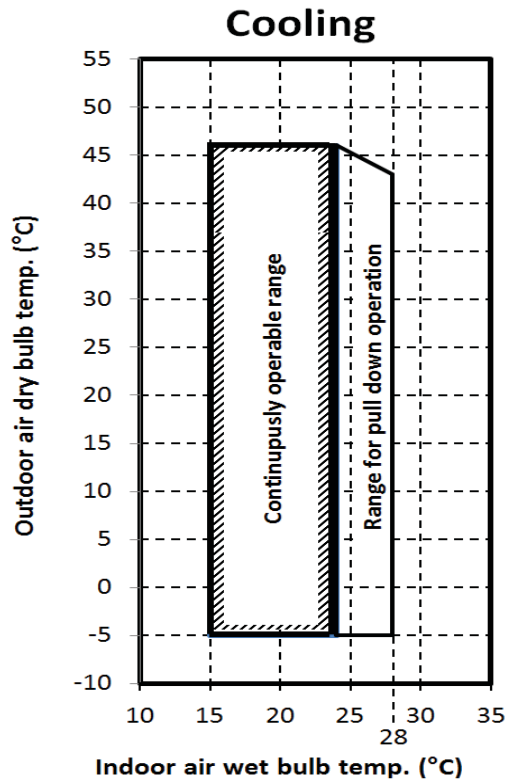

Note 1: The unit will operate down to an outdoor temperature of -25°C, however considerable performance decrease will be expected below -15°C. Therefore please consider installation location/surroundings and system design when expected to operate between -15°C and -20°C.

Note 2: Low ambient heating (-20°C or less) for extended periods of time is not allowed .



3-1. Free branching system

- [1] Line branching system
- [2] Header branching system
- [3] Header branching system after line branching
- [4] Line branching system after header branching
- [5] Header branching system after header branching

The above five branching systems enable to dramatically increase the flexibility of refrigerant piping design.

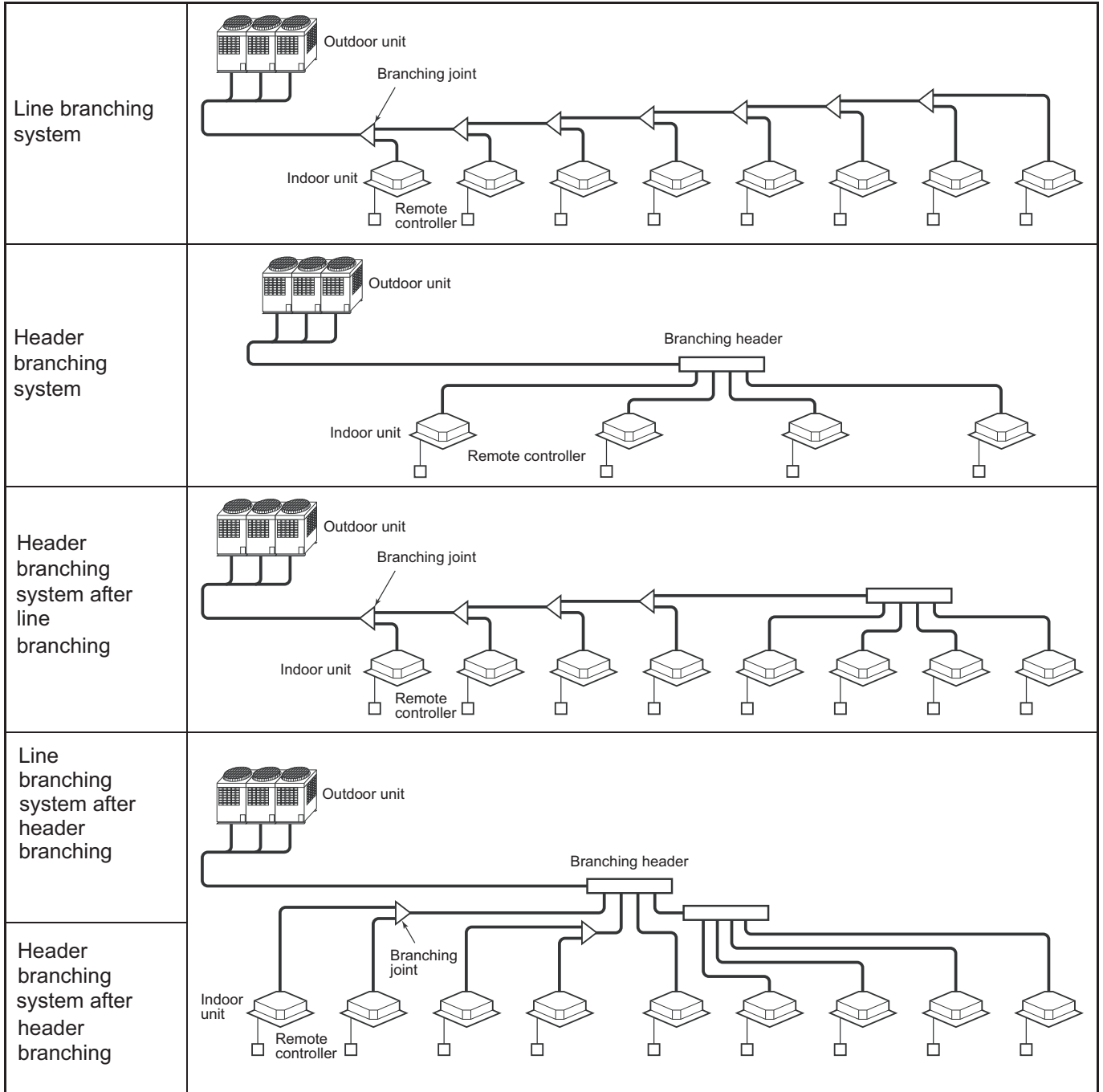



3-2. Allowable length/height difference of refrigerant piping

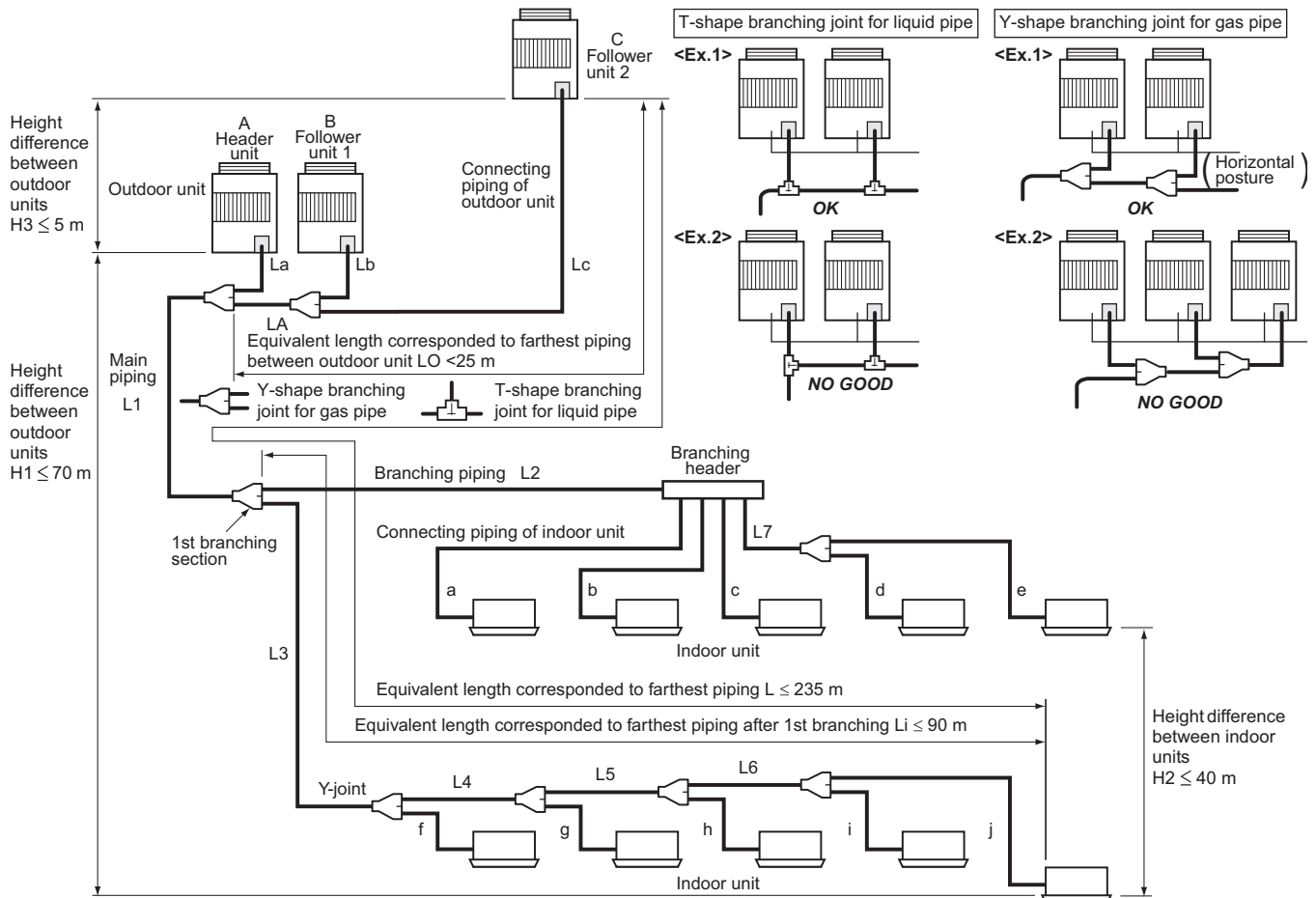

System restrictions

Max. No. of combined outdoor units	3 units	
Max. capacity of combined outdoor units	60 HP	
Max. No. of connected indoor units	64 units	
Max. capacity of combined indoor units	H2 ≤ 15	135 %
	H2 > 15	105 %

- Note 1)** Combination of outdoor units: Header unit (1 unit) + Follower units (0 to 2 units). Header unit is the outdoor unit nearest to the connected indoor units.
- Note 2)** Install the outdoor units in order of capacity. (Header unit ≥ Follower unit 1 ≥ Follower unit 2)
- Note 3)** Use Y-shape branching joint in connecting of gas pipe for outdoor unit, and install horizontally.
- Note 4)** Piping to indoor units shall be perpendicular to piping to the header outdoor unit as <Ex.1>. Do not connect piping to indoor units in the same direction of header outdoor unit as T-shape branching joint for liquid pipe of <Ex.2>.

Farthest piping length L(*1) by capacity of outdoor units

Capacity (HP)	Standard model				High efficiency model		
	8 ~ 22	24 ~ 44	46 ~ 52	54 ~ 60	20 ~ 22	36 ~ 44	54
Equivalent length (m)	210	220	185	185	220	235	185
Real length (m)	170	180	145	145	180	190	145

Note: All values of above table decrease 25 m when H1 exceeds 3 m.

Allowable length and height difference of refrigerant piping

Piping length	Total extension of pipe (Liquid pipe, real length)	Below 34HP 34HP or more	Allowable value	Piping section	
				Equivalent length	Real length
Piping length	Farthest piping Length L (*1)	Equivalent length	235 m	LA + LB + La + Lb + Lc + L1 + L2 + L3 + L4 + L5 + L6 + L7 + a + b + c + d + e + f + g + h + i + j	
		Real length	190 m	LA + L1 + L3 + L4 + L5 + L6 + j	
	Equivalent length of farthest piping from 1st branching Li (*1)		90 m (*2)	L3 + L4 + L5 + L6 + j	
	Equivalent length of farthest piping between outdoor units LO (*1)		25 m	LA + Lc (LA + Lb)	
	Max. equivalent length of main piping	Equivalent length	120 m (*3)	L1	
		Real length	100 m (*3)		
	Max. equivalent length of outdoor unit connecting piping		10 m	Lc (La, Lb,)	
	Max. real length of indoor unit connecting piping		30 m	a, b, c, d, e, f, g, h, i, j	
Max. equivalent length between branches		50 m	L2, L3, L4, L5, L6, L7		
Difference in height	Height between indoor and outdoor units H1	Upper outdoor unit	70 m (*4)(*7)	-	
		Lower outdoor unit	40 m (*5)	-	
	Height between indoor units H2		40 m	-	
	Height between outdoor units H3		5 m	-	

(*1) : (D) is outdoor unit furthest from the 1st branch and (j) is the indoor unit furthest from the 1st branch.
 (*2) : If the height difference (H1) between indoor and outdoor unit exceeds 3 m, set 65 m or less.
 (*3) : If the max. combined outdoor unit capacity is 54HP or more, then max. equivalent length is 70 m or less (real length is 50 m or less).
 (*4) : If the height difference (H2) between indoor units exceeds 3 m, set 50 m or less.
 (*5) : If the height difference (H2) between indoor units exceeds 3 m, set 30 m or less.
 (*6) : Total charging refrigerant is 140kg or less.
 (*7) : Extension up till 90m is possible with conditions below
 - Outdoor Temperature Cooling : 10 - 46 (DB)
 Heating : -5 - 15.5 (WB)
 - Equivalent length of farthest piping from 1st branching Li < 50m
 - Real length of main piping L1 < 100m
 - Height difference between indoor units H2 < 3m
 - Total capacity of combined indoor units : 90% - 105%
 - Single CDU, and up to 20HP
 - Minimum capacity of connectable indoor : unit 4HP or Larger



3-3. Selection of refrigerant piping

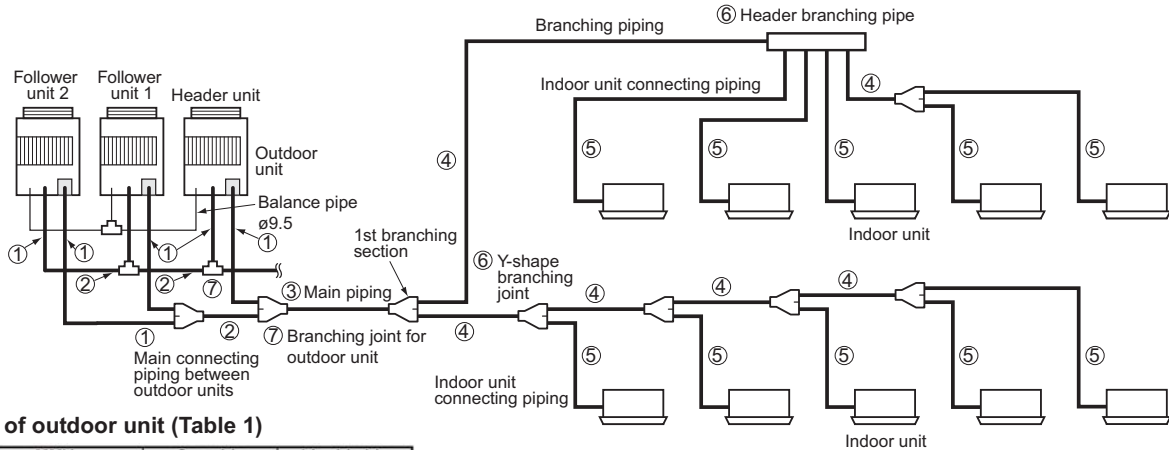

① Pipe size of outdoor unit (Table 1)

Model name MMY-	Gas side	Liquid side
MAP0806*	ø19.1	ø12.7
MAP1006*	ø22.2	ø12.7
MAP1206*	ø28.6	ø12.7
MAP1406*	ø28.6	ø15.9
MAP1606*	ø28.6	ø15.9
MAP1806*	ø28.6	ø15.9
MAP2006*	ø28.6	ø15.9
MAP2206*	ø28.6	ø19.1

② Connecting pipe size between outdoor units (Table 2)

Total capacity code of outdoor units at downstream side *1	Gas side	Liquid side	Balance pipe
16 to below 22	ø28.6	ø15.9	ø9.5
22 to below 24	ø28.6	ø19.1	
24 to below 26	ø34.9	ø19.1	
26 to below 36	ø34.9	ø19.1	
36 or more	ø41.3	ø22.2	

③ Size of main pipe (Table 3)

Total capacity code of all outdoor units *1	Gas side	Liquid side
8 below 10	ø 19.1	ø12.7
10 to below 12	ø 22.2	ø12.7
12 to below 14	ø28.6	ø12.7
14 to below 22	ø28.6	ø15.9
22 to below 24	ø28.6	ø19.1
24 to below 26	ø34.9	ø19.1
26 to below 36	ø34.9	ø19.1
36 or more	ø41.3	ø22.2

Determine thickness of the main pipe according to capacity of the outdoor units.

④ Pipe size between branching sections (Table 4)*5

Total capacity code of indoor units at downstream side *1	Gas side	Liquid side
2.4 or less	ø 12.7	ø9.5
2.4 to below 6.4	ø 15.9	ø9.5
6.4 to below 12.2	ø22.2	ø12.7
12.2 to below 20.2	ø28.6	ø15.9
20.2 to below 22.4	ø28.6	ø19.1
22.4 to below 25.2	ø34.9	ø19.1
25.2 to below 35.2	ø34.9	ø19.1
32.2 or more	ø41.3	ø22.2

If the total capacity code value of indoor units exceeds that of the outdoor units, apply the capacity code of outdoor units.

⑤ Piping of indoor unit (Table 5)

Capacity rank	Gas side	Liquid side
007 type to 012 type	ø12.7	ø6.4
Actual length 15 m or less		
015 type to 018 type	ø12.7	ø6.4
024 type to 056 type	ø15.9	ø9.5
072 type to 096 type	ø22.2	ø12.7

*1 Code is determined according to the capacity rank.

*2 When using a branching joint for the 1st branch, select according to capacity code of the outdoor unit.

*3 For 1 line after branching header indoor units with a maximum capacity code of 6.0 in total can be connected.

*4 If the pipe size is ø19.0 or more, use a suitable material as detailed in the installation manual.

*5 If the piping size becomes over main piping size, select the size same as main piping.

*6 When the first branch is a header with the outdoor total capacity codes of 12 to 26, apply the model RBM- HY2043E(4-branch) or RBM- HY2083E(8-branch) regardless of the total capacity codes of the down-stream indoor units.

*7 The maximum equivalent length of main pipe should be 70m or shorter.

*8 When the sum of capacity code of indoor units exceeds the capacity code of outdoor units, select according to capacity code of the outdoor units.

⑥ Selection of branching section (Table 6)

Y-shape branching joint *2 *3 *8	Total capacity code of indoor unit *1		Model name
	Below 6.4		
	6.4 to below 14.2		RBM-BY55E
	14.2 to below 25.2		RBM-BY105E
	25.2 or more		RBM-BY205E
Branching header *2 *3 *6 *8	For 4 branching	Below 14.2	RBM-BY305E
		14.2 to below 25.2	RBM-HY1043E
	For 8 branching	Below 14.2	RBM-HY2043E
		14.2 to below 25.2	RBM-HY1083E
		14.2 to below 25.2	RBM-HY2083E

⑦ Selection of branching joint for outdoor unit (Table 7)

	Total capacity code of outdoor unit	Joints			Model name
		Gas (Y-shape)	Liquid (T-shape)	Balance (T-shape)	
Branching joint for outdoor unit	Below 26	ø31.8 ø25.4	ø19.1 ø19.1	ø9.5 ø9.5	RBM-BT14E
	26 or more	ø38.1 ø28.6	ø22.2 ø22.2	ø9.5 ø9.5	RBM-BT24E

⑧ Minimum wall thickness for R410A application (Table 8)

Soft	Half hard or hard	OD (Inch)	OD (mm)	Minimum wall thickness (mm)
OK	OK	1/4"	6.35	0.80
OK	OK	3/8"	9.52	0.80
OK	OK	1/2"	12.70	0.80
OK	OK	5/8"	15.88	1.00
No Good*4	OK	3/4"	19.05	1.00
No Good*4	OK	7/8"	22.20	1.00
No Good*4	OK	1.1/8"	28.58	1.00
No Good*4	OK	1.3/8"	34.92	1.20
No Good*4	OK	1.5/8"	41.28	1.40



3-4. Charging requirement with additional refrigerant

Calculating the amount of additional refrigerant required

Refrigerant in the system when shipped from the factory

		8HP	10HP	12HP	14HP	16HP	18HP	20HP	22HP
Refrigerant amount charged in factory	Heat pump model	11.5 kg	11.5 kg	11.5 kg	11.5 kg	11.5 kg	11.5 kg	11.5 kg	11.5 kg

When the system is charged with refrigerant at the factory, the amount of refrigerant needed for the pipes at the site is not included. Therefore, calculate the additional amount needed and add the required amount to the system.

(Calculation)

Additional refrigerant charge amount is calculated based on the size of liquid pipe at site and its real length.

$$\text{Additional refrigerant charge amount at site} = [1] + [2] + ([3] \times 1.2)$$

[1]. Compensation by system HP (Table 1)

[2]. Additional refrigerant charge amount indoor unit (Table 2)

[3]. Real length of liquid pipe x Additional refrigerant charge amount per liquid pipe (Table 3)

Example: Additional charge amount R (kg) = [1] + [2] + ([3] x 1.2) = 2.5 + 24 + (39.1 x 1.2) = 73.4

System HP : 60HP

Indoor unit (Standard Indoor units) : 60HP

Liquid pipe : 22.2 100m

19.1 10m

15.9 10m

[1]. Compensation by system HP = 2.5kg

[2]. Additional refrigerant charge amount Indoor unit = 0.4 kg x 60 = 24kg

[3]. Real length of liquid pipe x Additional refrigerant charge amount per liquid pipe
 = (0.350 x 100) + (0.250 x 10) + (0.160 x 10) = 35 + 2.5 + 1.6 = 39.1kg

Table 1

Standard model

System	Combination			Compensation by System HP
HP	HP			kg
8	8			-3.5
10	10			-3.5
12	12			-1.5
14	14			-1.0
16	16			-0.5
18	18			1.5
20	20			1.5
22	22			1.5
24	12	12		-3.0
26	14	12		-2.5
28	16	12		-2.0
30	16	14		-1.5
32	16	16		-1.0
34	18	16		1.0
36	20	16		1.0
38	22	16		1.0
40	20	20		3.0
42	22	20		3.0
44	22	22		3.0
46	16	16	14	-6.5
48	16	16	16	-6.5
50	18	16	16	-0.5
52	20	16	16	-0.5
54	22	16	16	-0.5
56	20	20	16	2.5
58	22	20	16	2.5
60	22	22	16	2.5

High efficiency model

System	Combination			Compensation by System HP
HP	HP			kg
20	10	10		-7.0
22	12	10		-7.0
36	12	12	12	-12.5
38	14	12	12	-10.5
40	14	14	12	-8.5
42	14	14	14	-4.5
44	16	14	14	-4.5
54	20	20	14	1.5

Table 2

Additional refrigerant charge amount Indoor unit	kg/HP	Standard Indoor unit	Fresh Air Intake Indoor Unit	Air to Air Heat exchanger with DX-coil
		0.4	0.2	0.2
Additional refrigerant charge amount	kg/HP	0.4	0.2	0.2

Table 3

Pipe dia. at liquid side	mm	ø6.4	ø9.5	ø12.7	ø15.9	ø19.0	ø22.2
Additional refrigerant amount/1m	kg/m	0.025	0.055	0.105	0.16	0.25	0.35



4-1. General

- Perform wiring of the power supply in conformance with the regulations of the local electric company.
- For cabling of the power supply of the indoor unit and the inter-unit cabling between indoor and outdoor units, refer to the Installation Manual of indoor unit.
- Never connect power supply to the terminal block (U1, U2, U3, U4, U5, U6) for control wiring. (The equipment breaks down.)
- Arrange the cables so that the electric wires do not come to contact with high-temperature part of the pipe; otherwise coating melts and an accident may be caused.
- After connecting cable to the terminal block, take off the trap and then fix the cable with cable clamp.
- Do not turn on power of the indoor unit until vacuuming of the refrigerant pipe will finish.

4-2. Summary of wiring design

Design of outdoor unit power supply

- Select the wiring depending on MCA.
- Be sure to set the earth leakage breaker from the viewpoint of safety.

Design of indoor unit power supply

- Select the wiring depending on total current of indoor units.
- Determine the wire size for the length rules.
- Be sure to set the earth leakage breaker from the viewpoint of safety.

Design of control wiring

- Design each control wiring.
 - Between outdoor and indoor units,
 - Between indoor units/outdoor units
 - Between indoor unit and remote controller, central control, BMS
- Select the wire size and type depending on the length rules.

4-3. Electrical wiring design

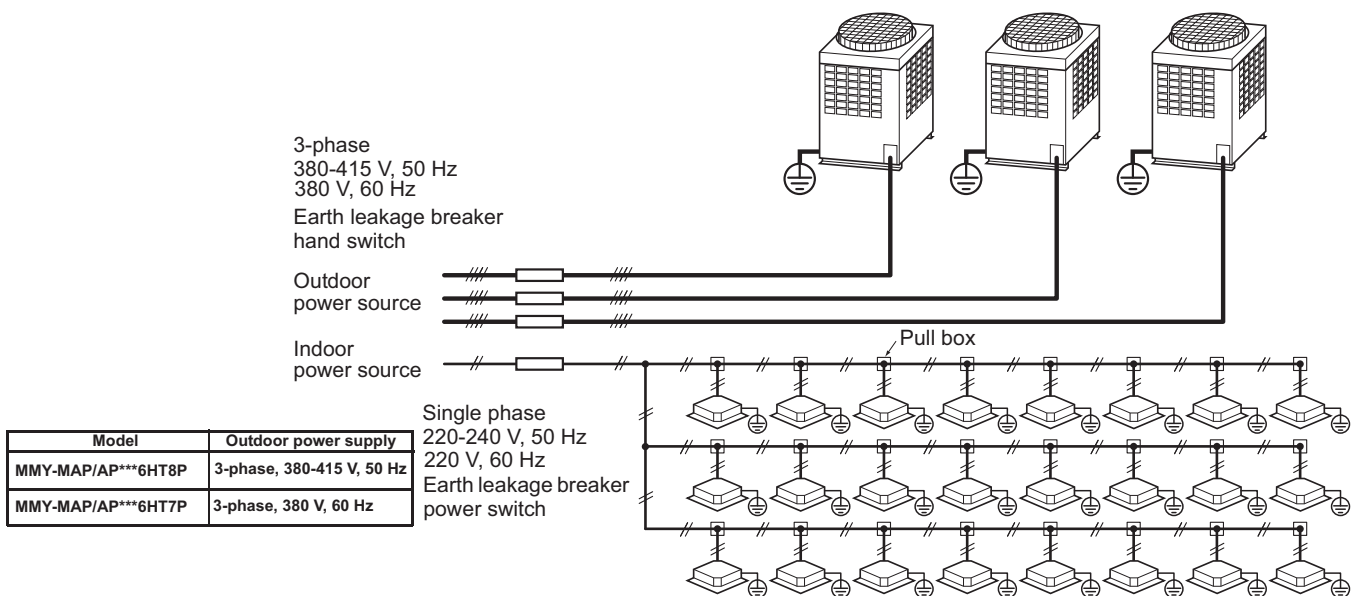

4-4. Outdoor unit power supply

4-4-1.

- Select the power supply cabling and fuse of each outdoor unit from the following specifications: cable 4-core, in conformance with Design 60245 IEC 66
- Do not connect the outdoor units by crossing outside of them, but connect them via the terminal block (L1, L2, L3, N).

Model	Outdoor power supply
MMY-MAP/AP***6HT8P	3-phase, 380-415 V, 50 Hz
MMY-MAP/AP***6HT7P	3-phase, 380 V, 60 Hz

Outdoor power supply
3-phase
380-415 V, 50 Hz
380 V, 60 Hz

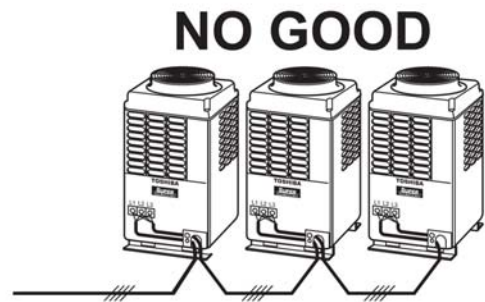



Outdoor unit data

Standard model

Type	HP	Heat Pump Model MMY-	Power Supply		Voltage Range		Compressor			Fan Motor (kW)	MCA (A)	MOCP (A)
			Phase and frequency	Nominal Voltage	Min. (V)	Max (V)	Unit No.1 (kW)	Unit No.2 (kW)	Unit No.3 (kW)			
Single unit	8	MMY-MAP0806HT8P	3N~ 50 Hz	380-400-415 V	342	456	2.1x2	-	-	1.0	20.5	25
	10	MMY-MAP1006HT8P	3N~ 50 Hz	380-400-415 V	342	456	3.1x2	-	-	1.0	21.5	25
	12	MMY-MAP1206HT8P	3N~ 50 Hz	380-400-415 V	342	456	3.9x2	-	-	1.0	26.1	32
	14	MMY-MAP1406HT8P	3N~ 50 Hz	380-400-415 V	342	456	4.8x2	-	-	1.0	31.0	40
	16	MMY-MAP1606HT8P	3N~ 50 Hz	380-400-415 V	342	456	5.8x2	-	-	1.0	35.8	40
	18	MMY-MAP1806HT8P	3N~ 50 Hz	380-400-415 V	342	456	6.5x2	-	-	2.0	40.6	50
	20	MMY-MAP2006HT8P	3N~ 50 Hz	380-400-415 V	342	456	7.6x2	-	-	2.0	44.9	63
	22	MMY-MAP2206HT8P	3N~ 50 Hz	380-400-415 V	342	456	9.0x2	-	-	2.0	49.3	63
Combination of outdoor unit	24	MMY-AP2416HT8P	3N~ 50 Hz	380-400-415 V	342	456	3.9x2	3.9x2	-	1.0+ 1.0	52.2	63
	26	MMY-AP2616HT8P	3N~ 50 Hz	380-400-415 V	342	456	4.8x2	3.9x2	-	1.0+ 1.0	57.1	63
	28	MMY-AP2816HT8P	3N~ 50 Hz	380-400-415 V	342	456	5.8x2	3.9x2	-	1.0+ 1.0	61.9	80
	30	MMY-AP3016HT8P	3N~ 50 Hz	380-400-415 V	342	456	5.8x2	4.8x2	-	1.0+ 1.0	66.8	80
	32	MMY-AP3216HT8P	3N~ 50 Hz	380-400-415 V	342	456	5.8x2	5.8x2	-	1.0+ 1.0	71.6	80
	34	MMY-AP3416HT8P	3N~ 50 Hz	380-400-415 V	342	456	6.5x2	5.8x2	-	2.0+ 1.0	76.4	100
	36	MMY-AP3616HT8P	3N~ 50 Hz	380-400-415 V	342	456	7.6x2	5.8x2	-	2.0+ 1.0	80.7	100
	38	MMY-AP3816HT8P	3N~ 50 Hz	380-400-415 V	342	456	9.0x2	5.8x2	-	2.0+ 1.0	85.1	100
	40	MMY-AP4016HT8P	3N~ 50 Hz	380-400-415 V	342	456	7.6x2	7.6x2	-	2.0+ 2.0	89.8	100
	42	MMY-AP4216HT8P	3N~ 50 Hz	380-400-415 V	342	456	9.0x2	7.6x2	-	2.0+ 2.0	94.2	125
	44	MMY-AP4416HT8P	3N~ 50 Hz	380-400-415 V	342	456	9.0x2	9.0x2	-	2.0+ 2.0	98.6	125
	46	MMY-AP4616HT8P	3N~ 50 Hz	380-400-415 V	342	456	5.8x2	5.8x2	4.8x2	1.0+1.0+1.0	102.6	125
	48	MMY-AP4816HT8P	3N~ 50 Hz	380-400-415 V	342	456	5.8x2	5.8x2	5.8x2	1.0+1.0+1.0	107.4	125
	50	MMY-AP5016HT8P	3N~ 50 Hz	380-400-415 V	342	456	6.5x2	5.8x2	5.8x2	2.0+1.0+1.0	112.2	125
	52	MMY-AP5216HT8P	3N~ 50 Hz	380-400-415 V	342	456	7.6x2	5.8x2	5.8x2	2.0+1.0+1.0	116.5	160
	54	MMY-AP5416HT8P	3N~ 50 Hz	380-400-415 V	342	456	9.0x2	5.8x2	5.8x2	2.0+1.0+1.0	120.9	160
56	MMY-AP5616HT8P	3N~ 50 Hz	380-400-415 V	342	456	7.6x2	7.6x2	5.8x2	2.0+2.0+1.0	125.6	160	
58	MMY-AP5816HT8P	3N~ 50 Hz	380-400-415 V	342	456	9.0x2	7.6x2	5.8x2	2.0+2.0+1.0	130.0	160	
60	MMY-AP6016HT8P	3N~ 50 Hz	380-400-415 V	342	456	9.0x2	9.0x2	5.8x2	2.0+2.0+1.0	134.4	160	

High efficiency / Heating capacity priority model

Type	HP	Heat Pump Model MMY-	Power Supply		Voltage Range		Compressor			Fan Motor (kW)	MCA (A)	MOCP (A)
			Phase and frequency	Nominal Voltage	Min. (V)	Max (V)	Unit No.1 (kW)	Unit No.2 (kW)	Unit No.3 (kW)			
Combination of outdoor unit	20	MMY-AP2026HT8P	3N~ 50 Hz	380-400-415 V	342	456	3.1x2	3.1x2	-	1.0+ 1.0	43.0	63
	22	MMY-AP2226HT8P	3N~ 50 Hz	380-400-415 V	342	456	3.9x2	3.1x2	-	1.0+ 1.0	47.6	63
	36	MMY-AP3626HT8P	3N~ 50 Hz	380-400-415 V	342	456	3.9x2	3.9x2	3.9x2	1.0+1.0+1.0	78.3	100
	38	MMY-AP3826HT8P	3N~ 50 Hz	380-400-415 V	342	456	4.8x2	3.9x2	3.9x2	1.0+1.0+1.0	83.2	100
	40	MMY-AP4026HT8P	3N~ 50 Hz	380-400-415 V	342	456	4.8x2	4.8x2	3.9x2	1.0+1.0+1.0	88.1	100
	42	MMY-AP4226HT8P	3N~ 50 Hz	380-400-415 V	342	456	4.8x2	4.8x2	4.8x2	1.0+1.0+1.0	93.0	125
	44	MMY-AP4426HT8P	3N~ 50 Hz	380-400-415 V	342	456	5.8x2	4.8x2	4.8x2	1.0+1.0+1.0	97.8	125
	54	MMY-AP5426HT8P	3N~ 50 Hz	380-400-415 V	342	456	7.6x2	7.6x2	4.8x2	2.0+2.0+1.0	120.8	160



Outdoor unit data

Standard model

Type	HP	Heat Pump Model MMY-	Power Supply		Voltage Range		Compressor			Fan Motor (kW)	MCA (A)	MOCP (A)
			Phase and frequency	Nominal Voltage	Min. (V)	Max (V)	Unit No.1 (kW)	Unit No.2 (kW)	Unit No.3 (kW)			
Single unit	8	MMY-MAP0806HT7P	3N~ 60 Hz	380 V	342	418	2.1x2	-	-	1.0	20.5	25
	10	MMY-MAP1006HT7P	3N~ 60 Hz	380 V	342	418	3.1x2	-	-	1.0	21.5	25
	12	MMY-MAP1206HT7P	3N~ 60 Hz	380 V	342	418	3.9x2	-	-	1.0	26.1	32
	14	MMY-MAP1406HT7P	3N~ 60 Hz	380 V	342	418	4.8x2	-	-	1.0	31.0	40
	16	MMY-MAP1606HT7P	3N~ 60 Hz	380 V	342	418	5.8x2	-	-	1.0	35.8	40
	18	MMY-MAP1806HT7P	3N~ 60 Hz	380 V	342	418	6.5x2	-	-	2.0	40.6	50
	20	MMY-MAP2006HT7P	3N~ 60 Hz	380 V	342	418	7.6x2	-	-	2.0	44.9	63
	22	MMY-MAP2206HT7P	3N~ 60 Hz	380 V	342	418	9.0x2	-	-	2.0	49.3	63
Combination of outdoor unit	24	MMY-AP2416HT7P	3N~ 60 Hz	380 V	342	418	3.9x2	3.9x2	-	1.0+1.0	52.2	63
	26	MMY-AP2616HT7P	3N~ 60 Hz	380 V	342	418	4.8x2	3.9x2	-	1.0+1.0	57.1	63
	28	MMY-AP2816HT7P	3N~ 60 Hz	380 V	342	418	5.8x2	3.9x2	-	1.0+1.0	61.9	80
	30	MMY-AP3016HT7P	3N~ 60 Hz	380 V	342	418	5.8x2	4.8x2	-	1.0+1.0	66.8	80
	32	MMY-AP3216HT7P	3N~ 60 Hz	380 V	342	418	5.8x2	5.8x2	-	1.0+1.0	71.6	80
	34	MMY-AP3416HT7P	3N~ 60 Hz	380 V	342	418	6.5x2	5.8x2	-	2.0+1.0	76.4	100
	36	MMY-AP3616HT7P	3N~ 60 Hz	380 V	342	418	7.6x2	5.8x2	-	2.0+1.0	80.7	100
	38	MMY-AP3816HT7P	3N~ 60 Hz	380 V	342	418	9.0x2	5.8x2	-	2.0+1.0	85.1	100
	40	MMY-AP4016HT7P	3N~ 60 Hz	380 V	342	418	7.6x2	7.6x2	-	2.0+2.0	89.8	100
	42	MMY-AP4216HT7P	3N~ 60 Hz	380 V	342	418	9.0x2	7.6x2	-	2.0+2.0	94.2	125
	44	MMY-AP4416HT7P	3N~ 60 Hz	380 V	342	418	9.0x2	9.0x2	-	2.0+2.0	98.6	125
	46	MMY-AP4616HT7P	3N~ 60 Hz	380 V	342	418	5.8x2	5.8x2	4.8x2	1.0+1.0+1.0	102.6	125
	48	MMY-AP4816HT7P	3N~ 60 Hz	380 V	342	418	5.8x2	5.8x2	5.8x2	1.0+1.0+1.0	107.4	125
	50	MMY-AP5016HT7P	3N~ 60 Hz	380 V	342	418	6.5x2	5.8x2	5.8x2	2.0+1.0+1.0	112.2	125
	52	MMY-AP5216HT7P	3N~ 60 Hz	380 V	342	418	7.6x2	5.8x2	5.8x2	2.0+1.0+1.0	116.5	160
	54	MMY-AP5416HT7P	3N~ 60 Hz	380 V	342	418	9.0x2	5.8x2	5.8x2	2.0+1.0+1.0	120.9	160
56	MMY-AP5616HT7P	3N~ 60 Hz	380 V	342	418	7.6x2	7.6x2	5.8x2	2.0+2.0+1.0	125.6	160	
58	MMY-AP5816HT7P	3N~ 60 Hz	380 V	342	418	9.0x2	7.6x2	5.8x2	2.0+2.0+1.0	130.0	160	
60	MMY-AP6016HT7P	3N~ 60 Hz	380 V	342	418	9.0x2	9.0x2	5.8x2	2.0+2.0+1.0	134.4	160	

High efficiency / Heating capacity priority model

Type	HP	Heat Pump Model MMY-	Power Supply		Voltage Range		Compressor			Fan Motor (kW)	MCA (A)	MOCP (A)
			Phase and frequency	Nominal Voltage	Min. (V)	Max (V)	Unit No.1 (kW)	Unit No.2 (kW)	Unit No.3 (kW)			
Combination of outdoor unit	20	MMY-AP2026HT7P	3N~ 60 Hz	380 V	342	418	3.1x2	3.1x2	-	1.0+1.0	43.0	63
	22	MMY-AP2226HT7P	3N~ 60 Hz	380 V	342	418	3.9x2	3.1x2	-	1.0+1.0	47.6	63
	36	MMY-AP3626HT7P	3N~ 60 Hz	380 V	342	418	3.9x2	3.9x2	3.9x2	1.0+1.0+1.0	78.3	100
	38	MMY-AP3826HT7P	3N~ 60 Hz	380 V	342	418	4.8x2	3.9x2	3.9x2	1.0+1.0+1.0	83.2	100
	40	MMY-AP4026HT7P	3N~ 60 Hz	380 V	342	418	4.8x2	4.8x2	3.9x2	1.0+1.0+1.0	88.1	100
	42	MMY-AP4226HT7P	3N~ 60 Hz	380 V	342	418	4.8x2	4.8x2	4.8x2	1.0+1.0+1.0	93.0	125
	44	MMY-AP4426HT7P	3N~ 60 Hz	380 V	342	418	5.8x2	4.8x2	4.8x2	1.0+1.0+1.0	97.8	125
	54	MMY-AP5426HT7P	3N~ 60 Hz	380 V	342	456	7.6x2	7.6x2	4.8x2	2.0+2.0+1.0	120.8	160



4-5. Indoor unit power supply

• Electrical characteristics for 50Hz outdoor units

Type	Model	Nominal Voltage	Voltage Range		Fan Motor		Power Supply	
		(V-Ph-Hz)	Min	Max	kW	FLA	MCA	MOCP
4-Way Air Discharge Cassette Type	MMU-AP0094HP-E	230-1-50	198	264	0.014	0.63	0.79	15
	MMU-AP0124HP-E	230-1-50	198	264	0.014	0.63	0.79	15
	MMU-AP0154HP-E	230-1-50	198	264	0.014	0.80	1.00	15
	MMU-AP0184HP-E	230-1-50	198	264	0.014	0.80	1.00	15
	MMU-AP0244HP-E	230-1-50	198	264	0.020	0.87	1.09	15
	MMU-AP0274HP-E	230-1-50	198	264	0.020	0.87	1.09	15
	MMU-AP0304HP-E	230-1-50	198	264	0.020	0.87	1.09	15
	MMU-AP0364HP-E	230-1-50	198	264	0.068	1.15	1.44	15
	MMU-AP0484HP-E	230-1-50	198	264	0.072	1.15	1.44	15
	MMU-AP0564HP-E	230-1-50	198	264	0.072	1.15	1.44	15
Compact 4-way Cassette (600 x 600) Type	MMU-AP0074MH-E	230-1-50	198	264	0.060	0.32	0.40	15
	MMU-AP0094MH-E	230-1-50	198	264	0.060	0.35	0.44	15
	MMU-AP0124MH-E	230-1-50	198	264	0.060	0.36	0.45	15
	MMU-AP0154MH-E	230-1-50	198	264	0.060	0.48	0.60	15
	MMU-AP0184MH-E	230-1-50	198	264	0.060	0.48	0.60	15
2-Way Air Discharge Cassette Type	MMU-AP0072WH	230-1-50	198	264	0.020	0.32	0.40	15
	MMU-AP0092WH	230-1-50	198	264	0.020	0.32	0.40	15
	MMU-AP0122WH	230-1-50	198	264	0.020	0.32	0.40	15
	MMU-AP0152WH	230-1-50	198	264	0.020	0.32	0.40	15
	MMU-AP0182WH	230-1-50	198	264	0.030	0.70	0.88	15
	MMU-AP0242WH	230-1-50	198	264	0.040	0.81	1.01	15
	MMU-AP0272WH	230-1-50	198	264	0.040	0.81	1.01	15
	MMU-AP0302WH	230-1-50	198	264	0.050	0.81	1.01	15
	MMU-AP0362WH	230-1-50	198	264	0.070	0.87	1.09	15
	MMU-AP0485WH	230-1-50	198	264	0.070	0.87	1.09	15
	MMU-AP0562WH	230-1-50	198	264	0.070	0.87	1.09	15
1-Way Air Discharge Cassette Type	MMU-AP0074YH-E	230-1-50	198	264	0.022	0.28	0.35	15
	MMU-AP0094YH-E	230-1-50	198	264	0.022	0.28	0.35	15
	MMU-AP0124YH-E	230-1-50	198	264	0.022	0.28	0.35	15
	MMU-AP0154SH-E	230-1-50	198	264	0.030	0.40	0.49	15
	MMU-AP0184SH-E	230-1-50	198	264	0.030	0.42	0.53	15
	MMU-AP0244SH-E	230-1-50	198	264	0.030	0.71	0.88	15
Concealed Duct Type	MMD-AP0076BHP-E	230-1-50	198	264	0.150	0.30	0.37	15
	MMD-AP0096BHP-E	230-1-50	198	264	0.150	0.34	0.42	15
	MMD-AP0126BHP-E	230-1-50	198	264	0.150	0.34	0.42	15
	MMD-AP0156BHP-E	230-1-50	198	264	0.150	0.48	0.61	15
	MMD-AP0186BHP-E	230-1-50	198	264	0.150	0.48	0.61	15
	MMD-AP0246BHP-E	230-1-50	198	264	0.150	0.60	0.75	15
	MMD-AP0276BHP-E	230-1-50	198	264	0.150	0.60	0.75	15
	MMD-AP0306BHP-E	230-1-50	198	264	0.150	0.70	0.88	15
	MMD-AP0366BHP-E	230-1-50	198	264	0.250	1.23	1.54	15
	MMD-AP0486BHP-E	230-1-50	198	264	0.250	1.41	1.77	15
Concealed Duct High Static Pressure Type	MMD-AP0186HP-E	230-1-50	198	264	0.25	1.02	1.28	15
	MMD-AP0246HP-E	230-1-50	198	264	0.25	1.33	1.66	15
	MMD-AP0276HP-E	230-1-50	198	264	0.25	1.33	1.66	15
	MMD-AP0366HP-E	230-1-50	198	264	0.35	2.22	2.78	15
	MMD-AP0486HP-E	230-1-50	198	264	0.35	2.40	2.99	15
	MMD-AP0566HP-E	230-1-50	198	264	0.35	2.57	3.22	15
	MMD-AP0724H-E	230-1-50	198	264	0.370x3	6.04	7.55	15
	MMD-AP0964H-E	230-1-50	198	264	0.370x3	6.35	7.94	15

Note MCA : Minimum Circuit Amps
 MCOP : Maximum Overcurrent Protection (Amps)



Slim Duct Type	MMD-AP0074SPH-E	230-1-50	198	264	0.060	0.35	0.44	15
	MMD-AP0094SPH-E	230-1-50	198	264	0.060	0.35	0.44	15
	MMD-AP0124SPH-E	230-1-50	198	264	0.060	0.37	0.47	15
	MMD-AP0154SPH-E	230-1-50	198	264	0.060	0.38	0.48	15
	MMD-AP0184SPH-E	230-1-50	198	264	0.060	0.47	0.59	15
	MMD-AP0244SPH-E	230-1-50	198	264	0.120	0.86	1.08	15
	MMD-AP0274SPH-E	230-1-50	198	264	0.120	0.86	1.08	15
CeilingType	MMC-AP0157HP-E	230-1-50	198	264	0.030	0.33	0.41	15
	MMC-AP0187HP-E	230-1-50	198	264	0.030	0.37	0.46	15
	MMC-AP0247HP-E	230-1-50	198	264	0.040	0.48	0.60	15
	MMC-AP0277HP-E	230-1-50	198	264	0.040	0.48	0.60	15
	MMC-AP0367HP-E	230-1-50	198	264	0.080	0.90	1.13	15
	MMC-AP0487HP-E	230-1-50	198	264	0.080	0.96	1.20	15
	MMC-AP0587HP-E	230-1-50	198	264	0.139	1.14	1.43	15
High-wall Type (3 series)	MMK-AP0073H	230-1-50	198	264	0.03	0.20	0.22	15
	MMK-AP0093H	230-1-50	198	264	0.03	0.22	0.24	15
	MMK-AP0123H	230-1-50	198	264	0.03	0.22	0.24	15
	MMK-AP0153H	230-1-50	198	264	0.03	0.37	0.4	15
	MMK-AP0183H	230-1-50	198	264	0.03	0.37	0.4	15
	MMK-AP0243H	230-1-50	198	264	0.03	0.43	0.47	15
Floor Standing Cabinet Type	MML-AP0074H-E	230-1-50	198	264	0.045	0.30	0.37	15
	MML-AP0094H-E	230-1-50	198	264	0.045	0.30	0.37	15
	MML-AP0124H-E	230-1-50	198	264	0.045	0.49	0.62	15
	MML-AP0154H-E	230-1-50	198	264	0.045	0.49	0.62	15
	MML-AP0184H-E	230-1-50	198	264	0.070	0.54	0.68	15
	MML-AP0244H-E	230-1-50	198	264	0.070	0.54	0.68	15
Floor Standing Concealed Type	MML-AP0074BH-E	230-1-50	198	264	0.019	0.29	0.36	15
	MML-AP0094BH-E	230-1-50	198	264	0.019	0.29	0.36	15
	MML-AP0124BH-E	230-1-50	198	264	0.019	0.29	0.36	15
	MML-AP0154BH-E	230-1-50	198	264	0.070	0.52	0.65	15
	MML-AP0184BH-E	230-1-50	198	264	0.070	0.52	0.65	15
	MML-AP0244BH-E	230-1-50	198	264	0.070	0.53	0.66	15
Floor Standing Type	MMF-AP0156H-E	230-1-50	198	264	0.062	0.44	0.55	15
	MMF-AP0186H-E	230-1-50	198	264	0.062	0.44	0.55	15
	MMF-AP0246H-E	230-1-50	198	264	0.062	0.69	0.86	15
	MMF-AP0276H-E	230-1-50	198	264	0.062	0.69	0.86	15
	MMF-AP0366H-E	230-1-50	198	264	0.109	1.04	1.29	15
	MMF-AP0486H-E	230-1-50	198	264	0.109	1.27	1.58	15
	MMF-AP0566H-E	230-1-50	198	264	0.109	1.27	1.58	15
Floor Standing Type Large capacity direct Type	MMF-AP0723H-VA	400-3-50	360	440	0.75	1.9	2.4	15
	MMF-AP0963H-VA	400-3-50	360	440	1.5	3.5	4.4	15
	MMF-AP1443H-VA	400-3-50	360	440	2.2	5.0	6.3	15
	MMF-AP1923H-VA	400-3-50	360	440	2.2	5.0	6.3	15
Floor Standing Type Large capacity duct Type	MMF-AP0723DH-V	400-3-50	360	440	1.5	3.5	4.4	15
	MMF-AP0963DH-V	400-3-50	360	440	1.5	3.5	4.4	15
	MMF-AP1443DH-V	400-3-50	360	440	2.2	5.0	6.3	15
	MMF-AP1923DH-V	400-3-50	360	440	3.7	8.0	10	15
Console Type	MML-AP0074NH-E	230-1-50	198	264	0.041	0.21	0.26	15
	MML-AP0094NH-E	230-1-50	198	264	0.041	0.21	0.26	15
	MML-AP0124NH-E	230-1-50	198	264	0.041	0.25	0.31	15
	MML-AP0154NH-E	230-1-50	198	264	0.041	0.32	0.40	15
MML-AP0184NH-E	230-1-50	198	264	0.041	0.46	0.58	15	



• Electrical characteristics for 60Hz outdoor units

Type	Model	Nominal Voltage (V-Ph-Hz)	Voltage Range		Fan Motor		Power Supply	
			Min	Max	kW	FLA	MCA	MOCP
4-Way Air Discharge Cassette Type	MMU-AP0094HP-E	220-1-60	198	242	0.014	0.66	0.83	15
	MMU-AP0124HP-E	220-1-60	198	242	0.014	0.66	0.83	15
	MMU-AP0154HP-E	220-1-60	198	242	0.014	0.84	1.05	15
	MMU-AP0184HP-E	220-1-60	198	242	0.014	0.84	1.05	15
	MMU-AP0244HP-E	220-1-60	198	242	0.020	0.91	1.14	15
	MMU-AP0274HP-E	220-1-60	198	242	0.020	0.91	1.14	15
	MMU-AP0304HP-E	220-1-60	198	242	0.020	0.91	1.14	15
	MMU-AP0364HP-E	220-1-60	198	242	0.068	1.21	1.51	15
Compact 4-way Cassette (600 x 600) Type	MMU-AP0484HP-E	220-1-60	198	242	0.072	1.21	1.51	15
	MMU-AP0564HP-E	220-1-60	198	242	0.072	1.21	1.51	15
	MMU-AP0074MH-E	220-1-60	198	242	0.060	0.31	0.39	15
	MMU-AP0094MH-E	220-1-60	198	242	0.060	0.33	0.41	15
	MMU-AP0124MH-E	220-1-60	198	242	0.060	0.35	0.44	15
2-Way Air Discharge Cassette Type	MMU-AP0154MH-E	220-1-60	198	242	0.060	0.47	0.59	15
	MMU-AP0184MH-E	220-1-60	198	242	0.060	0.47	0.59	15
	MMU-AP0072WH	220-1-60	198	242	0.020	0.30	0.38	15
	MMU-AP0092WH	220-1-60	198	242	0.020	0.30	0.38	15
	MMU-AP0122WH	220-1-60	198	242	0.020	0.30	0.38	15
	MMU-AP0152WH	220-1-60	198	242	0.020	0.30	0.38	15
	MMU-AP0182WH	220-1-60	198	242	0.030	0.67	0.84	15
	MMU-AP0242WH	220-1-60	198	242	0.040	0.77	0.96	15
	MMU-AP0272WH	220-1-60	198	242	0.040	0.77	0.96	15
	MMU-AP0302WH	220-1-60	198	242	0.050	0.77	0.96	15
1-Way Air Discharge Cassette Type	MMU-AP0362WH	220-1-60	198	242	0.070	0.83	1.04	15
	MMU-AP0485WH	220-1-60	198	242	0.070	0.83	1.04	15
	MMU-AP0562WH	220-1-60	198	242	0.070	0.83	1.04	15
	MMU-AP0074YH-E	220-1-60	198	242	0.022	0.30	0.37	15
	MMU-AP0094YH-E	220-1-60	198	242	0.022	0.30	0.37	15
	MMU-AP0124YH-E	220-1-60	198	242	0.022	0.30	0.37	15
Concealed Duct Type	MMU-AP0154SH-E	220-1-60	198	242	0.030	0.40	0.50	15
	MMU-AP0184SH-E	220-1-60	198	242	0.030	0.45	0.57	15
	MMU-AP0244SH-E	220-1-60	198	242	0.030	0.75	0.94	15
	MMD-AP0076BHP-E	220-1-60	198	242	0.150	0.31	0.39	15
	MMD-AP0096BHP-E	220-1-60	198	242	0.150	0.35	0.44	15
	MMD-AP0126BHP-E	220-1-60	198	242	0.150	0.35	0.44	15
	MMD-AP0156BHP-E	220-1-60	198	242	0.150	0.51	0.63	15
	MMD-AP0186BHP-E	220-1-60	198	242	0.150	0.51	0.63	15
	MMD-AP0246BHP-E	220-1-60	198	242	0.150	0.63	0.79	15
	MMD-AP0276BHP-E	220-1-60	198	242	0.150	0.63	0.79	15
Concealed Duct High Static Pressure Type	MMD-AP0306BHP-E	220-1-60	198	242	0.150	0.74	0.92	15
	MMD-AP0366BHP-E	220-1-60	198	242	0.250	1.28	1.61	15
	MMD-AP0486BHP-E	220-1-60	198	242	0.250	1.48	1.85	15
	MMD-AP0566BHP-E	220-1-60	198	242	0.250	1.48	1.85	15
	MMD-AP0186HP-E	220-1-60	198	242	0.250	1.07	1.33	15
	MMD-AP0246HP-E	220-1-60	198	242	0.250	1.39	1.73	15
	MMD-AP0276HP-E	220-1-60	198	242	0.250	1.39	1.73	15
	MMD-AP0366HP-E	220-1-60	198	242	0.350	2.32	2.90	15
Slim Duct Type	MMD-AP0486HP-E	220-1-60	198	242	0.350	2.50	3.13	15
	MMD-AP0566HP-E	220-1-60	198	242	0.350	2.69	3.36	15
	MMD-AP0724H-E	220-1-60	198	242	0.370x3	8.17	10.2	15
	MMD-AP0964H-E	220-1-60	198	242	0.370x3	8.53	10.7	15
	MMD-AP0074SPH-E	220-1-60	198	242	0.060	0.32	0.41	15
	MMD-AP0094SPH-E	220-1-60	198	242	0.060	0.32	0.41	15
Ceiling Type	MMD-AP0124SPH-E	220-1-60	198	242	0.060	0.36	0.45	15
	MMD-AP0154SPH-E	220-1-60	198	242	0.060	0.37	0.47	15
	MMD-AP0184SPH-E	220-1-60	198	242	0.060	0.44	0.56	15
	MMD-AP0244SPH-E	220-1-60	198	242	0.120	0.90	1.12	15
	MMD-AP0274SPH-E	220-1-60	198	242	0.120	0.90	1.12	15
	MMC-AP0157HP-E	220-1-60	198	242	0.094	0.42	0.53	15
MMC-AP0187HP-E	220-1-60	198	242	0.094	0.44	0.54	15	
MMC-AP0247HP-E	220-1-60	198	242	0.094	0.77	0.96	15	
MMC-AP0277HP-E	220-1-60	198	242	0.094	0.77	0.96	15	
MMC-AP0367HP-E	220-1-60	198	242	0.139	0.92	1.15	15	
MMC-AP0487HP-E	220-1-60	198	242	0.139	0.92	1.15	15	
MMC-AP0567HP-E	220-1-60	198	242	0.139	0.139	1.46	15	



Type	Model	Nominal Voltage (V-Ph-Hz)	Voltage Range		Fan Motor		Power Supply	
			Min	Max	kW	FLA	MCA	MOCP
High-wall Type (3 series)	MMK-AP0073H	220-1-60	198	242	0.030	0.20	0.22	15
	MMK-AP0093H	220-1-60	198	242	0.030	0.22	0.24	15
	MMK-AP0123H	220-1-60	198	242	0.030	0.22	0.24	15
	MMK-AP0153H	220-1-60	198	242	0.030	0.37	0.40	15
	MMK-AP0183H	220-1-60	198	242	0.030	0.37	0.40	15
	MMK-AP0243H	220-1-60	198	242	0.030	0.43	0.47	15
Floor Standing Cabinet Type	MML-AP0074H-E	220-1-60	198	242	0.045	0.29	0.36	15
	MML-AP0094H-E	220-1-60	198	242	0.045	0.29	0.36	15
	MML-AP0124H-E	220-1-60	198	242	0.045	0.51	0.63	15
	MML-AP0154H-E	220-1-60	198	242	0.045	0.51	0.63	15
	MML-AP0184H-E	220-1-60	198	242	0.070	0.61	0.76	15
	MML-AP0244H-E	220-1-60	198	242	0.070	0.61	0.76	15
Floor Standing Concealed Type	MML-AP0074BH-E	220-1-60	198	242	0.019	0.31	0.39	15
	MML-AP0094BH-E	220-1-60	198	242	0.019	0.31	0.39	15
	MML-AP0124BH-E	220-1-60	198	242	0.019	0.31	0.39	15
	MML-AP0154BH-E	220-1-60	198	242	0.070	0.53	0.66	15
	MML-AP0184BH-E	220-1-60	198	242	0.070	0.53	0.66	15
	MML-AP0244BH-E	220-1-60	198	242	0.070	0.59	0.73	15
Floor Standing Type	MMF-AP0156H-E	220-1-60	198	242	0.063	0.46	0.57	15
	MMF-AP0186H-E	220-1-60	198	242	0.063	0.46	0.57	15
	MMF-AP0246H-E	220-1-60	198	242	0.063	0.72	0.90	15
	MMF-AP0276H-E	220-1-60	198	242	0.063	0.72	0.90	15
	MMF-AP0366H-E	220-1-60	198	242	0.109	1.08	1.35	15
	MMF-AP0486H-E	220-1-60	198	242	0.109	1.32	1.65	15
Floor Standing Type Large capacity direct Type	MMF-AP0723H-VB	400-3-60	360	440	0.75	1.7	2.2	15
	MMF-AP0963H-VB	400-3-60	360	440	1.5	3.1	3.9	15
	MMF-AP1443H-VB	400-3-60	360	440	2.2	4.5	5.7	15
	MMF-AP1923H-VB	400-3-60	360	440	2.2	4.5	5.7	15
	MMF-AP0723DH-V	400-3-60	360	440	1.5	3.1	3.9	15
	MMF-AP0963DH-V	400-3-60	360	440	1.5	3.1	3.9	15
Floor Standing Type Large capacity duct Type	MMF-AP1443DH-V	400-3-60	360	440	2.2	4.5	5.7	15
	MMF-AP1923DH-V	400-3-60	360	440	3.7	7.4	9.3	15
	MMF-AP1923DH-V	400-3-60	360	440	3.7	7.4	9.3	15
Console Type	MML-AP0074NH-E	220-1-60	198	242	0.041	0.18	0.23	15
	MML-AP0094NH-E	220-1-60	198	242	0.041	0.18	0.23	15
	MML-AP0124NH-E	220-1-60	198	242	0.041	0.21	0.26	15
	MML-AP0154NH-E	220-1-60	198	242	0.041	0.27	0.34	15
	MML-AP0184NH-E	220-1-60	198	242	0.041	0.38	0.48	15



• **Wiring size**

Must be independent from the outdoor unit power supply

Model \ Item	Power supply wiring			
	Wire size			
All models of indoor units	2.0 mm ² (AWG#14)	Max. 20 m	3.5 mm ² (AWG#12)	Max. 50 m

NOTE:

The above connecting lengths stated in the table, indicate the length from the isolator to the outdoor unit. When the power supply of the indoor units are connected in parallel, it is assumed that no more than a 2 % voltage drop will occur. If the connecting length is to exceed the stated lengths, select a suitable wire in accordance with the local wiring standards.

4-6.Design of control wiring

• Summary of control wiring

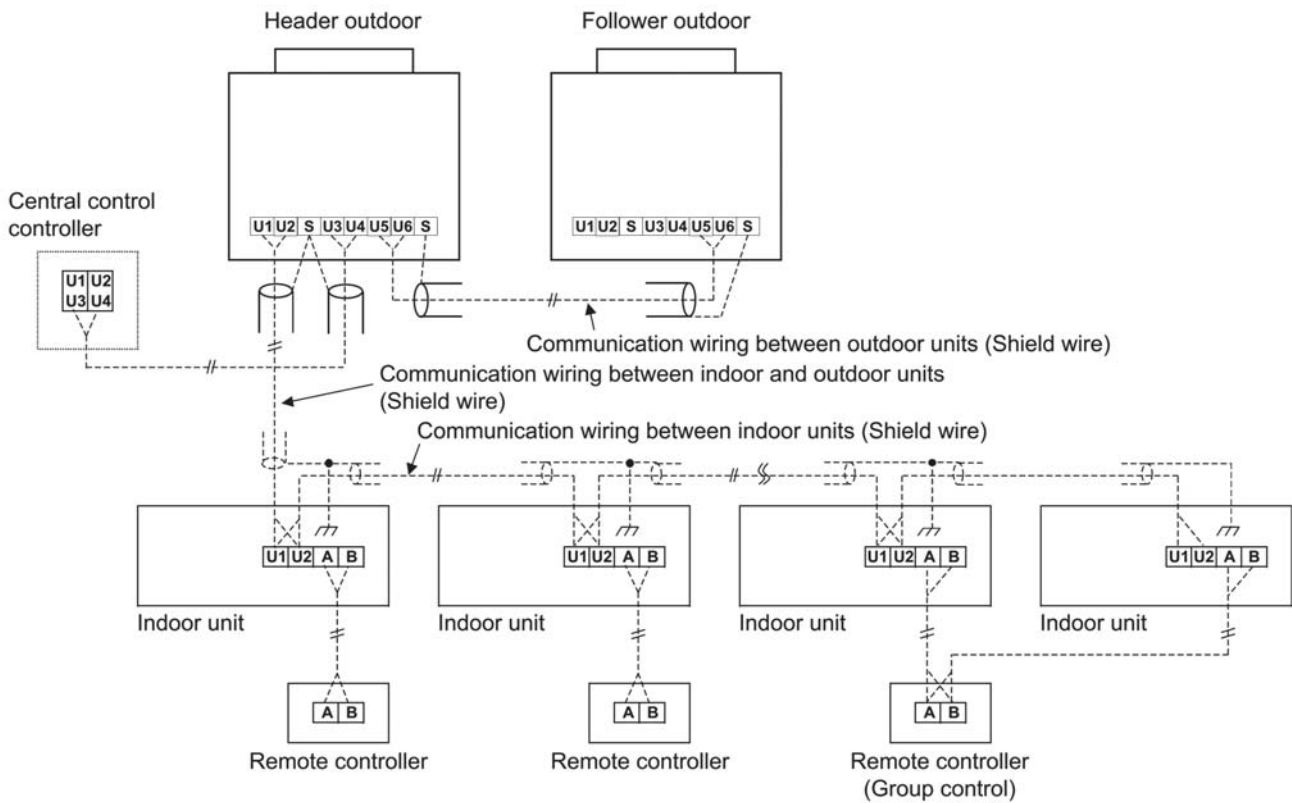

- Communication wiring and central control wiring use 2-core non-polarity wires.
Use 2-core shield wires to prevent noise trouble.
In this case, both ends of the communication wire must be grounded.
- Use 2-core non-polarity wire for remote controller. (A, B terminals)
Use 2-core non-polarity wire for wiring of group control. (A, B terminals)

• Restriction of control wiring

Be sure to keep the rule of below tables about size and length of control wiring.

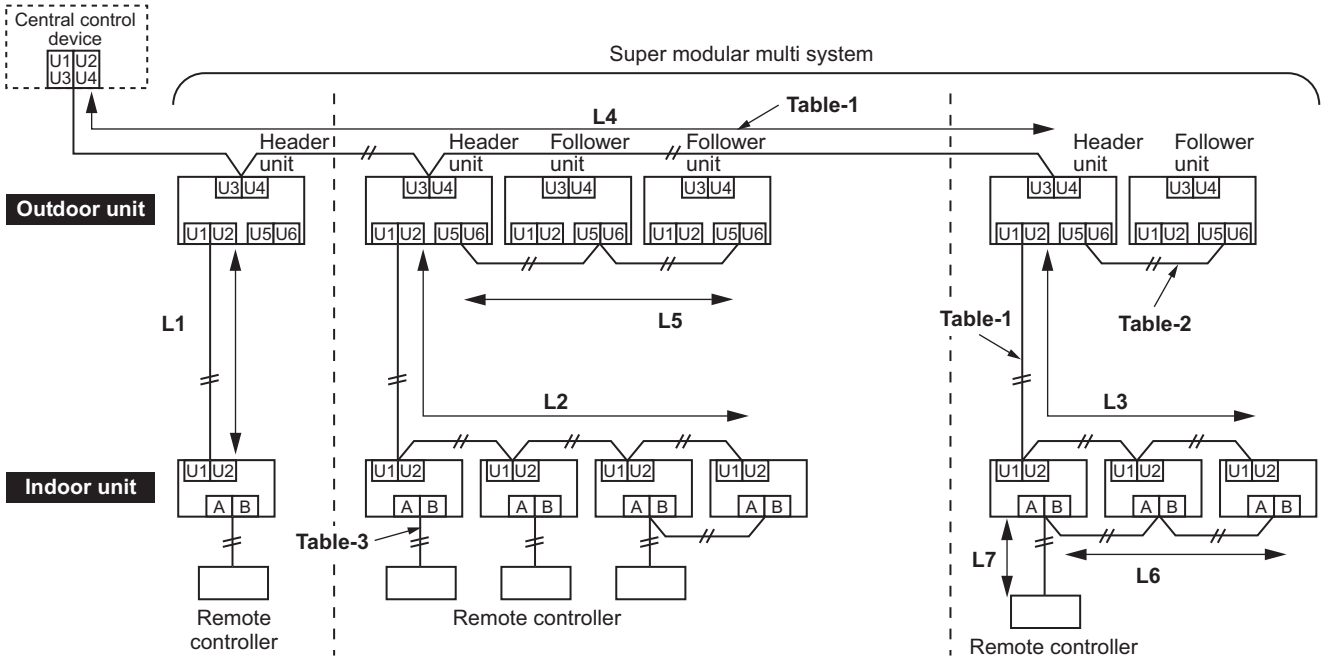

Table-1 Control wiring between indoor and outdoor units (L1, L2, L3), Central control wiring (L4)

Wiring	2-core, non-polarity
Type	Shield wire
Size/Length	1.25 mm ² : Up to 1000 m/2.0 mm ² : Up to 2000 m (*1)

Note (*1): Total length of control wiring length for all refrigerant circuits (L1 + L2 + L3 + L4)

Table-2 Control wiring between outdoor units (L5)

Wiring	2-core, non-polarity
Type	Shield wire
Size/Length	1.25 mm ² to 2.0 mm ² /Up to 100 m (L5)

Table-3 Remote controller wiring (L6, L7)

Wire	2-core
Size	0.5 mm ² to 2.0 mm ²
Length	<ul style="list-style-type: none"> • Up to 500 m (L6 + L7) • Up to 400 m in case of wireless remote controller in group control. • Up to 200 m total length of control wiring between indoor units (L6)

• Group Operation through a Remote Controller

Group operation of multiple indoor units (8 units) through a single remote controller switch

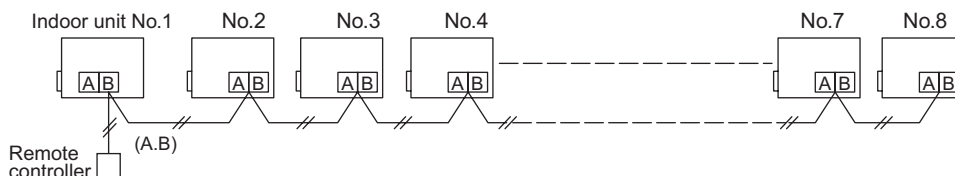



5-1. Specifications

Standard model (50Hz/380~415V)

Model name		Heat pump	MMY-MAP0806HT8P	MMY-MAP1006HT8P	MMY-MAP1206HT8P	MMY-MAP1406HT8P	
Outdoor unit type			Inverter unit	Inverter unit	Inverter unit	Inverter unit	
Cooling capacity (*1)		kW	22.4	28.0	33.5	40.0	
Heating capacity (*1)		kW	25.0	31.5	37.5	45.0	
Capacity range		HP	8	10	12	14	
Power supply			3N~ 50Hz 400V(380-415V)	3N~ 50Hz 400V(380-415V)	3N~ 50Hz 400V(380-415V)	3N~ 50Hz 400V(380-415V)	
Voltage range (*2)		Minimum	V	342	342	342	
		Maximum	V	456	456	456	
Electrical characteristic (*1)		Cooling	Running current	A	8.23	11.4	14.6
			Power input	kW	5.19	7.26	9.41
			EER	kW/kW	4.32	3.86	3.56
		Heating	Running current	A	8.53	11.1	14.3
			Power input	kW	5.38	7.08	9.24
			COP	kW/kW	4.65	4.45	4.06
Starting current		A	Soft Start	Soft Start	Soft Start	Soft Start	
Dimension		Height	mm	1800	1800	1800	
		Width	mm	990	990	990	
		Depth	mm	780	780	780	
Weight		Heat pump	kg	242	242	242	
Colour			Silky shade (Munsell 1Y8.5/0.5)	Silky shade (Munsell 1Y8.5/0.5)	Silky shade (Munsell 1Y8.5/0.5)	Silky shade (Munsell 1Y8.5/0.5)	
Compressor		Type	Hermetic twin rotary compressor	Hermetic twin rotary compressor	Hermetic twin rotary compressor	Hermetic twin rotary compressor	
		Motor output	kW	2.1x2	3.1x2	3.9x2	4.8x2
Fan unit		Type	Propeller fan	Propeller fan	Propeller fan	Propeller fan	
		Motor output	kW	1.0	1.0	1.0	1.0
Air volume		m3/h	9700	9700	12200	12200	
Max. external static pressure		Pa	60	60	50	50	
Heat exchanger			Finned tube	Finned tube	Finned tube	Finned tube	
Refrigerant		Name	R410A	R410A	R410A	R410A	
		Charge	kg	11.5	11.5	11.5	11.5
High-pressure switch		Mpa	OFF:3.2 ON:4.15	OFF:3.2 ON:4.15	OFF:3.2 ON:4.15	OFF:3.2 ON:4.15	
Protective devices			(*3)	(*3)	(*3)	(*3)	
Power supply wiring		MCA (*4)	A	20.5	21.5	26.1	
		MOCP (*5)	A	25.0	25.0	32.0	
Piping connections		Gas	Type	Brazing	Brazing	Brazing	
			Diameter	mm	19.1	22.2	28.6
		Liquid	Type	Flare	Flare	Flare	
			Diameter	mm	12.7	12.7	12.7
		Balance	Type	Flare	Flare	Flare	
			Diameter	mm	9.5	9.5	9.5
Max. number of connected indoor units			13	16	20	23	
Sound pressure level		Cooling	dB(A)	55	57	59	
		Heating	dB(A)	56	58	61	
Operation temperature range		Cooling	CDB	-5 to 46	-5 to 46	-5 to 46	
		Heating(*6)	CWB	-25 to 15.5	-25 to 15.5	-25 to 15.5	

Note

(*1) Rated conditions Cooling : Indoor 27 degC Dry Bulb / 19 degC Wet Bulb, Outdoor 35 degC Dry Bulb.

Heating : Indoor 20 degC Dry Bulb, Outdoor 7 degC Dry Bulb / 6 degC Wet Bulb.

Based on equivalent piping length of 7.5 m and piping height difference of 0 m.

(*2) Voltage range : Units are suitable for use on electrical systems where voltage supplied to unit terminal is not below or above listed range limits.

(*3) Discharge temp. sensor / Suction temp. sensor / High-pressure sensor / Low-pressure sensor / High-pressure switch / P.C. board fuse

(*4) Select wire size base on the larger value of MCA.

MCA : Minimum Circuit Amps

(*5) MOCP : Maximum Overcurrent Protection (Amps)

(*6) Low ambient heating (-20degC or less) for extended periods of time is not allowed



Standard model (50Hz/380~415V)

Model name		Heat pump		MMY-MAP1606HT8P	MMY-MAP1806HT8P	MMY-MAP2006HT8P	MMY-MAP2206HT8P
Outdoor unit type				Inverter unit	Inverter unit	Inverter unit	Inverter unit
Cooling capacity (*1)		kW		45.0	50.4	56.0	61.5
Heating capacity (*1)		kW		50.0	56.0	63.0	64.0
Capacity range		HP		16	18	20	22
Power supply				3N~ 50Hz 400V(380-415V)	3N~ 50Hz 400V(380-415V)	3N~ 50Hz 400V(380-415V)	3N~ 50Hz 400V(380-415V)
Voltage range (*2)		Minimum	V	342	342	342	342
		Maximum	V	456	456	456	456
Electrical characteristic (*1)	Cooling	Running current	A	21.3	22.0	27.8	32.2
		Power input	kW	13.6	14.0	17.9	21.0
		EER	kW/kW	3.31	3.60	3.13	2.93
		Running current	A	19.6	21.3	25.3	25.8
	Heating	Power input	kW	12.5	13.6	16.5	16.6
		COP	kW/kW	4.00	4.12	3.82	3.86
		Starting current	A	Soft Start	Soft Start	Soft Start	Soft Start
		Dimension		Height	mm	1800	1800
		Width	mm	1210	1600	1600	1600
		Depth	mm	780	780	780	780
Weight		Heat pump	kg	299	370	370	370
Colour				Silky shade (Munsell 1Y8.5/0.5)	Silky shade (Munsell 1Y8.5/0.5)	Silky shade (Munsell 1Y8.5/0.5)	Silky shade (Munsell 1Y8.5/0.5)
Compressor	Type			Hermetic twin rotary compressor	Hermetic twin rotary compressor	Hermetic twin rotary compressor	Hermetic twin rotary compressor
	Motor output	kW		5.8x2	6.5x2	7.6x2	9.0x2
Fan unit	Type			Propeller fan	Propeller fan	Propeller fan	Propeller fan
	Motor output	kW		1.0	2.0	2.0	2.0
	Air volume	m3/h		12600	17300	17900	18500
Max. external static pressure				Pa	40	50	40
Heat exchanger				Finned tube	Finned tube	Finned tube	Finned tube
Refrigerant	Name			R410A	R410A	R410A	R410A
	Charge	Heat pump	kg	11.5	11.5	11.5	11.5
High-pressure switch				Mpa	OFF:3.2 ON:4.15	OFF:3.2 ON:4.15	OFF:3.2 ON:4.15
Protective devices				(*3)	(*3)	(*3)	(*3)
Power supply wiring		MCA (*4)	A	35.8	40.6	44.9	49.3
		MOCP (*5)	A	40.0	50.0	63.0	63.0
Piping connections	Gas	Type			Brazing	Brazing	Brazing
		Diameter	mm	28.6	28.6	28.6	28.6
	Liquid	Type			Flare	Flare	Flare
		Diameter	mm	15.9	15.9	15.9	19.1
	Balance	Type			Flare	Flare	Flare
		Diameter	mm	9.5	9.5	9.5	9.5
Max. number of connected indoor units					27	30	33
Sound pressure level		Cooling	dB(A)	62	60	61	61
		Heating	dB(A)	64	61	62	62
Operation temperature range		Cooling	CDB	-5 to 46	-5 to 46	-5 to 46	-5 to 46
		Heating(*6)	CWB	-25 to 15.5	-25 to 15.5	-25 to 15.5	-25 to 15.5

Note

(*1) Rated conditions Cooling : Indoor 27 degC Dry Bulb / 19 degC Wet Bulb, Outdoor 35 degC Dry Bulb.

Heating : Indoor 20 degC Dry Bulb, Outdoor 7 degC Dry Bulb / 6 degC WetBulb.

Based on equivalent piping length of 7.5 m and piping height difference of 0 m.

(*2) Voltage range : Units are suitable for use on electrical systems where voltage supplied to unit terminal is not below or above listed range limits.

(*3) Discharge temp. sensor / Suction temp. sensor / High-pressure sensor / Low-pressure sensor / High-pressure switch / P.C. board fuse

(*4) Select wire size base on the larger value of MCA.

MCA : Minimum Circuit Amps

(*5) MOCP : Maximum Overcurrent Protection (Amps)

(*6) Low ambient heating (-20degC or less) for extended periods of time is not allowed



Standard model (50Hz/380~415V)

Model	Name	Heat pump		MMY-AP2416HT8P	MMY-AP2616HT8P	MMY-AP2816HT8P	MMY-AP3016HT8P
	Combination	Heat pump		MMY-MAP1206HT8P	MMY-MAP1406HT8P	MMY-MAP1606HT8P	MMY-MAP1606HT8P
				MMY-MAP1206HT8P	MMY-MAP1206HT8P	MMY-MAP1206HT8P	MMY-MAP1406HT8P
Outdoor unit type				Inverter unit	Inverter unit	Inverter unit	Inverter unit
Cooling capacity (*1)			kW	67.0	73.5	78.5	85.0
Heating capacity (*1)			kW	75.0	82.5	87.5	95.0
Capacity range			HP	24	26	28	30
Power supply				3N~ 50Hz 400V(380-415V)	3N~ 50Hz 400V(380-415V)	3N~ 50Hz 400V(380-415V)	3N~ 50Hz 400V(380-415V)
Voltage range (*2)		Minimum	V	342	342	342	342
		Maximum	V	456	456	456	456
Electrical characteristic (*1)	Cooling	Running current	A	29.2	32.8	35.9	39.5
		Power input	kW	18.8	20.9	23.0	25.1
		EER	kW/kW	3.56	3.52	3.41	3.39
	Heating	Running current	A	28.6	31.1	33.9	36.4
		Power input	kW	18.5	19.8	21.7	23.1
		COP	kW/kW	4.06	4.16	4.02	4.11
	Starting current		A	Soft Start	Soft Start	Soft Start	Soft Start
Weight	Heat pump	kg	242 + 242	299 + 242	299 + 242	299 + 299	
Colour				Silky shade (Munsell 1Y8.5/0.5)	Silky shade (Munsell 1Y8.5/0.5)	Silky shade (Munsell 1Y8.5/0.5)	Silky shade (Munsell 1Y8.5/0.5)
Compressor	Type			Hermetic twin rotary compressor	Hermetic twin rotary compressor	Hermetic twin rotary compressor	Hermetic twin rotary compressor
	Motor output	kW		3.9x2 + 3.9x2	4.8x2 + 3.9x2	5.8x2 + 3.9x2	5.8x2 + 4.8x2
Fan unit	Fan			Propeller fan	Propeller fan	Propeller fan	Propeller fan
	Motor output	kW		1.0 + 1.0	1.0 + 1.0	1.0 + 1.0	1.0 + 1.0
	Air volume	m3/h		12200 + 12200	12200 + 12200	12600 + 12200	12600 + 12200
Max. external static pressure			Pa	50	50	40	40
Heat exchanger				Finned tube	Finned tube	Finned tube	Finned tube
Refrigerant	Name			R410A	R410A	R410A	R410A
	Charge	Heat pump	kg	11.5 + 11.5	11.5 + 11.5	11.5 + 11.5	11.5 + 11.5
High-pressure switch			Mpa	OFF:3.2 ON:4.15	OFF:3.2 ON:4.15	OFF:3.2 ON:4.15	OFF:3.2 ON:4.15
Protective devices				(*3)	(*3)	(*3)	(*3)
Power supply wiring		MCA (*4)	A	52.2	57.1	61.9	66.8
		MOCP (*5)	A	63.0	63.0	80.0	80.0
Piping connections	Gas	Type		Brazing	Brazing	Brazing	Brazing
		Diameter	mm	34.9	34.9	34.9	34.9
	Liquid	Type		Flare	Flare	Flare	Flare
		Diameter	mm	19.1	19.1	19.1	19.1
	Balance	Type		Flare	Flare	Flare	Flare
		Diameter	mm	9.5	9.5	9.5	9.5
Max. number of connected indoor units				40	43	47	50
Sound pressure level		Cooling	dB(A)	62.0	62.5	64.0	64.5
		Heating	dB(A)	64.0	64.5	66.0	66.5
Operation temperature range		Cooling	CDB	-5 to 46	-5 to 46	-5 to 46	-5 to 46
		Heating(*6)	CWB	-25 to 15.5	-25 to 15.5	-25 to 15.5	-25 to 15.5

Note

(*1) Rated conditions Cooling : Indoor 27 degC Dry Bulb / 19 degC Wet Bulb, Outdoor 35 degC Dry Bulb.

Heating : Indoor 20 degC Dry Bulb, Outdoor 7 degC Dry Bulb / 6 degC Wet Bulb.

Based on equivalent piping length of 7.5 m and piping height difference of 0 m.

(*2) Voltage range : Units are suitable for use on electrical systems where voltage supplied to unit terminal is not below or above listed range limits.

(*3) Discharge temp. sensor / Suction temp. sensor / High-pressure sensor / Low-pressure sensor / High-pressure switch / P.C. board fuse

(*4) Select wire size base on the larger value of MCA.

MCA : Minimum Circuit Amps

(*5) MOCP : Maximum Overcurrent Protection (Amps)

(*6) Low ambient heating (-20degC or less) for extended periods of time is not allowed



Standard model (50Hz/380~415V)

Model	Name	Heat pump		MMY-AP3216HT8P	MMY-AP3416HT8P	MMY-AP3616HT8P	MMY-AP3816HT8P
	Combination	Heat pump		MMY-MAP1606HT8P	MMY-MAP1806HT8P	MMY-MAP2006HT8P	MMY-MAP2206HT8P
				MMY-MAP1606HT8P	MMY-MAP1606HT8P	MMY-MAP1606HT8P	MMY-MAP1606HT8P
Outdoor unit type				Inverter unit	Inverter unit	Inverter unit	Inverter unit
Cooling capacity (*1)			kW	90.0	95.4	101.0	106.5
Heating capacity (*1)			kW	100.0	106.0	113.0	114.0
Capacity range			HP	32	34	36	38
Power supply				3N~ 50Hz 400V(380-415V)	3N~ 50Hz 400V(380-415V)	3N~ 50Hz 400V(380-415V)	3N~ 50Hz 400V(380-415V)
Voltage range (*2)		Minimum	V	342	342	342	342
		Maximum	V	456	456	456	456
Electrical characteristic (*1)	Cooling	Running current	A	42.6	43.3	49.1	53.5
		Power input	kW	27.2	27.6	31.5	34.6
		EER	kW/kW	3.31	3.46	3.21	3.08
	Heating	Running current	A	39.2	40.9	44.9	45.4
		Power input	kW	25.0	26.1	29.0	29.1
		COP	kW/kW	4.00	4.06	3.90	3.92
	Starting current		A	Soft Start	Soft Start	Soft Start	Soft Start
Weight	Heat pump	kg	299 + 299	370 + 299	370 + 299	370 + 299	
Colour				Silky shade (Munsell 1Y8.5/0.5)	Silky shade (Munsell 1Y8.5/0.5)	Silky shade (Munsell 1Y8.5/0.5)	Silky shade (Munsell 1Y8.5/0.5)
Compressor	Type			Hermetic twin rotary compressor	Hermetic twin rotary compressor	Hermetic twin rotary compressor	Hermetic twin rotary compressor
	Motor output		kW	5.8x2 + 5.8x2	6.5x2 + 5.8x2	7.6x2 + 5.8x2	9.0x2 + 5.8x2
Fan unit	Fan			Propeller fan	Propeller fan	Propeller fan	Propeller fan
	Motor output		kW	1.0 + 1.0	2.0 + 1.0	2.0 + 1.0	2.0 + 1.0
	Air volume		m3/h	12600 + 12600	17300 + 12600	17900 + 12600	18500 + 12600
Max. external static pressure			Pa	40	40	40	40
Heat exchanger				Finned tube	Finned tube	Finned tube	Finned tube
Refrigerant	Name			R410A	R410A	R410A	R410A
	Charge	Heat pump	kg	11.5 + 11.5	11.5 + 11.5	11.5 + 11.5	11.5 + 11.5
High-pressure switch			Mpa	OFF:3.2 ON:4.15	OFF:3.2 ON:4.15	OFF:3.2 ON:4.15	OFF:3.2 ON:4.15
Protective devices				(*3)	(*3)	(*3)	(*3)
Power supply wiring		MCA (*4)	A	71.6	76.4	80.7	85.1
		MOCP (*5)	A	80.0	100.0	100.0	100.0
Piping connections	Gas	Type		Brazing	Brazing	Brazing	Brazing
		Diameter	mm	34.9	34.9	41.3	41.3
	Liquid	Type		Flare	Flare	Flare	Flare
		Diameter	mm	19.1	19.1	22.2	22.2
	Balance	Type		Flare	Flare	Flare	Flare
		Diameter	mm	9.5	9.5	9.5	9.5
Max. number of connected indoor units				54	57	60	64
Sound pressure level		Cooling	dB(A)	65.0	64.5	64.5	64.5
		Heating	dB(A)	67.0	66.0	66.5	66.5
Operation temperature range		Cooling	CDB	-5 to 46	-5 to 46	-5 to 46	-5 to 46
		Heating(*6)	CWB	-25 to 15.5	-25 to 15.5	-25 to 15.5	-25 to 15.5

Note

(*1) Rated conditions Cooling : Indoor 27 degC Dry Bulb / 19 degC Wet Bulb, Outdoor 35 degC Dry Bulb.

Heating : Indoor 20 degC Dry Bulb, Outdoor 7 degC Dry Bulb / 6 degC Wet Bulb.

Based on equivalent piping length of 7.5 m and piping height difference of 0 m.

(*2) Voltage range : Units are suitable for use on electrical systems where voltage supplied to unit terminal is not below or above listed range limits.

(*3) Discharge temp. sensor / Suction temp. sensor / High-pressure sensor / Low-pressure sensor / High-pressure switch / P.C. board fuse

(*4) Select wire size base on the larger value of MCA.

MCA : Minimum Circuit Amps

(*5) MOCP : Maximum Overcurrent Protection (Amps)

(*6) Low ambient heating (-20degC or less) for extended periods of time is not allowed



Standard model (50Hz/380~415V)

Model	Name	Heat pump		MMY-AP4016HT8P	MMY-AP4216HT8P	MMY-AP4416HT8P
	Combination	Heat pump		MMY-MAP2006HT8P	MMY-MAP2006HT8P	MMY-MAP2006HT8P
Outdoor unit type				Inverter unit	Inverter unit	Inverter unit
Cooling capacity (*1)			kW	112.0	117.5	123.0
Heating capacity (*1)			kW	126.0	127.0	128.0
Capacity range			HP	40	42	44
Power supply				3N~ 50Hz 400V(380-415V)	3N~ 50Hz 400V(380-415V)	3N~ 50Hz 400V(380-415V)
Voltage range (*2)		Minimum	V	342	342	342
		Maximum	V	456	456	456
Electrical characteristic (*1)	Cooling	Running current	A	55.6	60.0	64.4
		Power input	kW	35.8	38.9	42.0
		EER	kW/kW	3.13	3.02	2.93
	Heating	Running current	A	50.6	51.1	51.6
		Power input	kW	33.0	33.1	33.2
		COP	kW/kW	3.82	3.84	3.86
Starting current		A	Soft Start	Soft Start	Soft Start	
Weight	Heat pump	kg	370 + 370	370 + 370	370 + 370	
Colour				Silky shade (Munsell 1Y8.5/0.5)	Silky shade (Munsell 1Y8.5/0.5)	Silky shade (Munsell 1Y8.5/0.5)
Compressor	Type			Hermetic twin rotary compressor	Hermetic twin rotary compressor	Hermetic twin rotary compressor
	Motor output	kW		7.6x2 + 7.6x2	9.0x2 + 7.6x2	9.0x2 + 9.0x2
Fan unit	Fan			Propeller fan	Propeller fan	Propeller fan
	Motor output	kW		2.0 + 2.0	2.0 + 2.0	2.0 + 2.0
	Air volume	m3/h		17900 + 17900	18500 + 17900	18500 + 18500
Max. external static pressure			Pa	40	40	40
Heat exchanger				Finned tube	Finned tube	Finned tube
Refrigerant	Name			R410A	R410A	R410A
	Charge	Heat pump	kg	11.5 + 11.5	11.5 + 11.5	11.5 + 11.5
High-pressure switch			Mpa	OFF:3.2 ON:4.15	OFF:3.2 ON:4.15	OFF:3.2 ON:4.15
Protective devices				(*3)	(*3)	(*3)
Power supply wiring		MCA (*4)	A	89.8	94.2	98.6
		MOCP (*5)	A	100.0	125.0	125.0
Piping connections	Gas	Type		Brazing	Brazing	Brazing
		Diameter	mm	41.3	41.3	41.3
	Liquid	Type		Flare	Flare	Flare
		Diameter	mm	22.2	22.2	22.2
	Balance	Type		Flare	Flare	Flare
		Diameter	mm	9.5	9.5	9.5
Max. number of connected indoor units				64	64	64
Sound pressure level		Cooling	dB(A)	64.0	64.0	64.0
		Heating	dB(A)	65.0	65.0	65.0
Operation temperature range		Cooling	CDB	-5 to 46	-5 to 46	-5 to 46
		Heating(*6)	CWB	-25 to 15.5	-25 to 15.5	-25 to 15.5

Note

(*1) Rated conditions Cooling : Indoor 27 degC Dry Bulb / 19 degC Wet Bulb, Outdoor 35 degC Dry Bulb.

Heating : Indoor 20 degC Dry Bulb, Outdoor 7 degC Dry Bulb / 6 degC Wet Bulb.

Based on equivalent piping length of 7.5 m and piping height difference of 0 m.

(*2) Voltage range : Units are suitable for use on electrical systems where voltage supplied to unit terminal is not below or above listed range limits.

(*3) Discharge temp. sensor / Suction temp. sensor / High-pressure sensor / Low-pressure sensor / High-pressure switch / P.C. board fuse

(*4) Select wire size base on the larger value of MCA.

MCA : Minimum Circuit Amps

(*5) MOCP : Maximum Overcurrent Protection (Amps)

(*6) Low ambient heating (-20degC or less) for extended periods of time is not allowed



Standard model (50Hz/380~415V)

Model	Name	Heat pump		MMY-AP4616HT8P	MMY-AP4816HT8P	MMY-AP5016HT8P
	Combination	Heat pump		MMY-MAP1606HT8P	MMY-MAP1606HT8P	MMY-MAP1606HT8P
Outdoor unit type				Inverter unit	Inverter unit	Inverter unit
Cooling capacity (*1)		kW		130.0	135.0	140.4
Heating capacity (*1)		kW		145.0	150.0	156.0
Capacity range		HP		46	48	50
Power supply				3N~ 50Hz 400V(380-415V)	3N~ 50Hz 400V(380-415V)	3N~ 50Hz 400V(380-415V)
Voltage range (*2)		Minimum	V	342	342	342
		Maximum	V	456	456	456
Electrical characteristic (*1)	Cooling	Running current	A	60.8	63.9	64.6
		Power input	kW	38.7	40.8	41.2
		EER	kW/kW	3.36	3.31	3.41
	Heating	Running current	A	56.0	58.8	60.5
		Power input	kW	35.6	37.5	38.6
		COP	kW/kW	4.07	4.00	4.04
	Starting current	A		Soft Start	Soft Start	Soft Start
Weight	Heat pump	kg		299 + 299 + 299	299 + 299 + 299	370 + 299 + 299
Colour				Silky shade (Munsell 1Y8.5/0.5)	Silky shade (Munsell 1Y8.5/0.5)	Silky shade (Munsell 1Y8.5/0.5)
Compressor	Type			Hermetic twin rotary compressor	Hermetic twin rotary compressor	Hermetic twin rotary compressor
	Motor output	kW		5.8x2 + 5.8x2 + 4.8x2	5.8x2 + 5.8x2 + 5.8x2	6.5x2 + 5.8x2 + 5.8x2
Fan unit	Fan			Propeller fan	Propeller fan	Propeller fan
	Motor output	kW		1.0 + 1.0 + 1.0	1.0 + 1.0 + 1.0	2.0 + 1.0 + 1.0
	Air volume	m ³ /h		12600 + 12600 + 12200	12600 + 12600 + 12600	17300 + 12600 + 12600
Max. external static pressure		Pa		40	40	40
Heat exchanger				Finned tube	Finned tube	Finned tube
Refrigerant	Name			R410A	R410A	R410A
	Charge	Heat pump	kg	11.5 + 11.5 + 11.5	11.5 + 11.5 + 11.5	11.5 + 11.5 + 11.5
High-pressure switch		Mpa		OFF:3.2 ON:4.15	OFF:3.2 ON:4.15	OFF:3.2 ON:4.15
Protective devices				(*3)	(*3)	(*3)
Power supply wiring		MCA (*4)	A	102.6	107.4	112.2
		MOCP (*5)	A	125.0	125.0	125.0
Piping connections	Gas	Type		Brazing	Brazing	Brazing
		Diameter	mm	41.3	41.3	41.3
	Liquid	Type		Flare	Flare	Flare
		Diameter	mm	22.2	22.2	22.2
	Balance	Type		Flare	Flare	Flare
		Diameter	mm	9.5	9.5	9.5
Max. number of connected indoor units				64	64	64
Sound pressure level		Cooling	dB(A)	66.5	67.0	66.5
		Heating	dB(A)	68.5	69.0	68.0
Operation temperature range		Cooling	CDB	-5 to 46	-5 to 46	-5 to 46
		Heating(*6)	CWB	-25 to 15.5	-25 to 15.5	-25 to 15.5

Note

(*1) Rated conditions Cooling : Indoor 27 degC Dry Bulb / 19 degC Wet Bulb, Outdoor 35 degC Dry Bulb.
Heating : Indoor 20 degC Dry Bulb, Outdoor 7 degC Dry Bulb / 6 degC WetBulb.

Based on equivalent piping length of 7.5 m and piping height difference of 0 m.

(*2) Voltage range : Units are suitable for use on electrical systems where voltage supplied to unit terminal is not below or above listed range limits.

(*3) Discharge temp. sensor / Suction temp. sensor / High-pressure sensor / Low-pressure sensor / High-pressure switch / P.C. board fuse

(*4) Select wire size base on the larger value of MCA.

MCA : Minimum Circuit Amps

(*5) MOCP : Maximum Overcurrent Protection (Amps)

(*6) Low ambient heating (-20degC or less) for extended periods of time is not allowed



Standard model (50Hz/380~415V)

Model	Name	Heat pump		MMY-AP5216HT8P	MMY-AP5416HT8P	MMY-AP5616HT8P
	Combination	Heat pump		MMY-MAP2006HT8P	MMY-MAP2206HT8P	MMY-MAP2006HT8P
				MMY-MAP1606HT8P	MMY-MAP1606HT8P	MMY-MAP2006HT8P
				MMY-MAP1606HT8P	MMY-MAP1606HT8P	MMY-MAP1606HT8P
Outdoor unit type				Inverter unit	Inverter unit	Inverter unit
Cooling capacity (*1)			kW	146.0	151.5	157.0
Heating capacity (*1)			kW	163.0	164.0	176.0
Capacity range			HP	52	54	56
Power supply				3N~ 50Hz 400V(380-415V)	3N~ 50Hz 400V(380-415V)	3N~ 50Hz 400V(380-415V)
Voltage range (*2)	Minimum		V	342	342	342
	Maximum		V	456	456	456
Electrical characteristic (*1)	Cooling	Running current	A	70.4	74.8	76.9
		Power input	kW	45.1	48.2	49.4
		EER	kW/kW	3.24	3.14	3.18
	Heating	Running current	A	64.5	65.0	70.2
		Power input	kW	41.5	41.6	45.5
		COP	kW/kW	3.93	3.94	3.87
	Starting current		A	Soft Start	Soft Start	Soft Start
Weight	Heat pump		kg	370 + 299 + 299	370 + 299 + 299	370 + 370 + 299
Colour				Silky shade (Munsell 1Y8.5/0.5)	Silky shade (Munsell 1Y8.5/0.5)	Silky shade (Munsell 1Y8.5/0.5)
Compressor	Type			Hermetic twin rotary compressor	Hermetic twin rotary compressor	Hermetic twin rotary compressor
	Motor output		kW	7.6x2 + 5.8x2 + 5.8x2	9.0x2 + 5.8x2 + 5.8x2	7.6x2 + 7.6x2 + 5.8x2
Fan unit	Fan			Propeller fan	Propeller fan	Propeller fan
	Motor output		kW	2.0 + 1.0 + 1.0	2.0 + 1.0 + 1.0	2.0 + 2.0 + 1.0
	Air volume		m3/h	17900 + 12600 + 12600	18500 + 12600 + 12600	17900 + 17900 + 12600
Max. external static pressure			Pa	40	40	40
Heat exchanger				Finned tube	Finned tube	Finned tube
Refrigerant	Name			R410A	R410A	R410A
	Charge	Heat pump	kg	11.5 + 11.5 + 11.5	11.5 + 11.5 + 11.5	11.5 + 11.5 + 11.5
High-pressure switch			Mpa	OFF:3.2 ON:4.15	OFF:3.2 ON:4.15	OFF:3.2 ON:4.15
Protective devices				(*3)	(*3)	(*3)
Power supply wiring	MCA (*4)		A	116.5	120.9	125.6
	MOCP (*5)		A	160.0	160.0	160.0
Piping connections	Gas	Type		Brazing	Brazing	Brazing
		Diameter	mm	41.3	41.3	41.3
	Liquid	Type		Flare	Flare	Flare
		Diameter	mm	22.2	22.2	22.2
	Balance	Type		Flare	Flare	Flare
		Diameter	mm	9.5	9.5	9.5
Max. number of connected indoor units				64	64	64
Sound pressure level	Cooling		dB(A)	66.5	66.5	66.5
	Heating		dB(A)	68.5	68.5	67.5
Operation temperature range	Cooling		CDB	-5 to 46	-5 to 46	-5 to 46
	Heating(*6)		CWB	-25 to 15.5	-25 to 15.5	-25 to 15.5

Note

(*1) Rated conditions Cooling : Indoor 27 degC Dry Bulb / 19 degC Wet Bulb, Outdoor 35 degC Dry Bulb.
Heating : Indoor 20 degC Dry Bulb, Outdoor 7 degC Dry Bulb / 6 degC Wet Bulb.
Based on equivalent piping length of 7.5 m and piping height difference of 0 m.

(*2) Voltage range : Units are suitable for use on electrical systems where voltage supplied to unit terminal is not below or above listed range limits.

(*3) Discharge temp. sensor / Suction temp. sensor / High-pressure sensor / Low-pressure sensor / High-pressure switch / P.C. board fuse

(*4) Select wire size base on the larger value of MCA.

MCA : Minimum Circuit Amps

(*5) MOCP : Maximum Overcurrent Protection (Amps)

(*6) Low ambient heating (-20degC or less) for extended periods of time is not allowed

Standard model (50Hz/380~415V)

Model	Name	Heat pump		MMY-AP5816HT8P	MMY-AP6016HT8P
	Combination	Heat pump		MMY-MAP2206HT8P	MMY-MAP2206HT8P
				MMY-MAP2006HT8P	MMY-MAP2206HT8P
				MMY-MAP1606HT8P	MMY-MAP1606HT8P
Outdoor unit type				Inverter unit	Inverter unit
Cooling capacity (*1)			kW	162.5	168.0
Heating capacity (*1)			kW	177.0	178.0
Capacity range			HP	58	60
Power supply				3N~ 50Hz 400V(380-415V)	3N~ 50Hz 400V(380-415V)
Voltage range (*2)		Minimum	V	342	342
		Maximum	V	456	456
Electrical characteristic (*1)	Cooling	Running current	A	81.3	85.7
		Power input	kW	52.5	55.6
		EER	kW/kW	3.10	3.02
	Heating	Running current	A	70.7	71.2
		Power input	kW	45.6	45.7
		COP	kW/kW	3.88	3.89
	Starting current		A	Soft Start	Soft Start
Weight	Heat pump	kg	370 + 370 + 299	370 + 370 + 299	
Colour				Silky shade (Munsell 1Y8.5/0.5)	Silky shade (Munsell 1Y8.5/0.5)
Compressor	Type			Hermetic twin rotary compressor	Hermetic twin rotary compressor
	Motor output	kW		9.0x2 + 7.6x2 + 5.8x2	9.0x2 + 9.0x2 + 5.8x2
Fan unit	Fan			Propeller fan	Propeller fan
	Motor output	kW		2.0 + 2.0 + 1.0	2.0 + 2.0 + 1.0
	Air volume	m3/h		18500 + 17900 + 12600	18500 + 18500 + 12600
Max. external static pressure			Pa	40	40
Heat exchanger				Finned tube	Finned tube
Refrigerant	Name			R410A	R410A
	Charge	Heat pump	kg	11.5 + 11.5 + 11.5	11.5 + 11.5 + 11.5
High-pressure switch			Mpa	OFF:3.2 ON:4.15	OFF:3.2 ON:4.15
Protective devices				(*3)	(*3)
Power supply wiring		MCA (*4)	A	130.0	134.4
		MOCP (*5)	A	160.0	160.0
Piping connections	Gas	Type		Brazing	Brazing
		Diameter	mm	41.3	41.3
	Liquid	Type		Flare	Flare
		Diameter	mm	22.2	22.2
	Balance	Type		Flare	Flare
		Diameter	mm	9.5	9.5
Max. number of connected indoor units				64	64
Sound pressure level		Cooling	dB(A)	66.5	66.5
		Heating	dB(A)	67.5	67.5
Operation temperature range		Cooling	CDB	-5 to 46	-5 to 46
		Heating(*6)	CWB	-25 to 15.5	-25 to 15.5

Note

(*1) Rated conditions Cooling : Indoor 27 degC Dry Bulb / 19 degC Wet Bulb, Outdoor 35 degC Dry Bulb.
Heating : Indoor 20 degC Dry Bulb, Outdoor 7 degC Dry Bulb / 6 degC Wet Bulb.
Based on equivalent piping length of 7.5 m and piping height difference of 0 m.

(*2) Voltage range : Units are suitable for use on electrical systems where voltage supplied to unit terminal is not below or above listed range limits.

(*3) Discharge temp. sensor / Suction temp. sensor / High-pressure sensor / Low-pressure sensor / High-pressure switch / P.C. board fuse

(*4) Select wire size base on the larger value of MCA.

MCA : Minimum Circuit Amps

(*5) MOCP : Maximum Overcurrent Protection (Amps)

(*6) Low ambient heating (-20degC or less) for extended periods of time is not allowed

High efficiency / Heating capacity priority model (50Hz/380~415V)

Model	Name	Heat pump		MMY-AP2026HT8P	MMY-AP2226HT8P
	Combination	Heat pump		MMY-MAP1006HT8P	MMY-MAP1206HT8P
Outdoor unit type				Inverter unit	Inverter unit
Cooling capacity (*1)			kW	56.0	61.5
Heating capacity (*1)			kW	63.0	69.0
Capacity range			HP	20	22
Power supply				3N~ 50Hz 400V(380-415V)	3N~ 50Hz 400V(380-415V)
Voltage range (*2)		Minimum	V	342	342
		Maximum	V	456	456
Electrical characteristic (*1)	Cooling	Running current	A	22.8	26.0
		Power input	kW	14.5	16.7
		EER	kW/kW	3.86	3.69
	Heating	Running current	A	22.2	25.4
		Power input	kW	14.2	16.3
		COP	kW/kW	4.45	4.23
Starting current		A	Soft Start	Soft Start	
Weight		Heat pump	kg	242 + 242	242 + 242
Colour				Silky shade (Munsell 1Y8.5/0.5)	Silky shade (Munsell 1Y8.5/0.5)
Compressor	Type			Hermetic twin rotary compressor	Hermetic twin rotary compressor
	Motor output		kW	3.1x2 + 3.1x2	3.9x2 + 3.1x2
Fan unit	Fan			Propeller fan	Propeller fan
	Motor output		kW	1.0 + 1.0	1.0 + 1.0
	Air volume		m3/h	9700 + 9700	12200 + 9700
Max. external static pressure			Pa	60	50
Heat exchanger				Finned tube	Finned tube
Refrigerant	Name			R410A	R410A
	Charge	Heat pump	kg	11.5 + 11.5	11.5 + 11.5
High-pressure switch			Mpa	OFF:3.2 ON:4.15	OFF:3.2 ON:4.15
Protective devices				(*3)	(*3)
Power supply wiring		MCA (*4)	A	43.0	47.6
		MOCP (*5)	A	63.0	63.0
Piping connections	Gas	Type		Brazing	Brazing
		Diameter	mm	28.6	28.6
	Liquid	Type		Flare	Flare
		Diameter	mm	15.9	19.1
	Balance	Type		Flare	Flare
		Diameter	mm	9.5	9.5
Max. number of connected indoor units				33	37
Sound pressure level		Cooling	dB(A)	60.0	61.5
		Heating	dB(A)	61.0	63.0
Operation temperature range		Cooling	CDB	-5 to 46	-5 to 46
		Heating(*6)	CWB	-25 to 15.5	-25 to 15.5

Note

(*1) Rated conditions Cooling : Indoor 27 degC Dry Bulb / 19 degC Wet Bulb, Outdoor 35 degC Dry Bulb.

Heating : Indoor 20 degC Dry Bulb, Outdoor 7 degC Dry Bulb / 6 degC Wet Bulb.

Based on equivalent piping length of 7.5 m and piping height difference of 0 m.

(*2) Voltage range : Units are suitable for use on electrical systems where voltage supplied to unit terminal is not below or above listed range limits.

(*3) Discharge temp. sensor / Suction temp. sensor / High-pressure sensor / Low-pressure sensor / High-pressure switch / P.C. board fuse

(*4) Select wire size base on the larger value of MCA.

MCA : Minimum Circuit Amps

(*5) MOCP : Maximum Overcurrent Protection (Amps)

(*6) Low ambient heating (-20degC or less) for extended periods of time is not allowed



High efficiency / Heating capacity priority model (50Hz/380~415V)

Model	Name	Heat pump		MMY-AP3626HT8P	MMY-AP3826HT8P	MMY-AP4026HT8P
	Combination	Heat pump		MMY-MAP1206HT8P	MMY-MAP1406HT8P	MMY-MAP1406HT8P
				MMY-MAP1206HT8P	MMY-MAP1206HT8P	MMY-MAP1206HT8P
Outdoor unit type				Inverter unit	Inverter unit	Inverter unit
Cooling capacity (*1)			kW	100.5	107.0	113.5
Heating capacity (*1)			kW	112.5	120.0	127.5
Capacity range			HP	36	38	40
Power supply				3N~ 50Hz 400V(380-415V)	3N~ 50Hz 400V(380-415V)	3N~ 50Hz 400V(380-415V)
Voltage range (*2)		Minimum	V	342	342	342
		Maximum	V	456	456	456
Electrical characteristic (*1)	Cooling	Running current	A	43.8	47.4	51.0
		Power input	kW	28.2	30.3	32.4
		EER	kW/kW	3.56	3.53	3.50
	Heating	Running current	A	42.9	45.4	47.9
		Power input	kW	27.7	29.1	30.4
		COP	kW/kW	4.06	4.13	4.19
	Starting current	A	Soft Start	Soft Start	Soft Start	
Weight	Heat pump	kg	242 + 242 + 242	299 + 242 + 242	299 + 299 + 242	
Colour				Silky shade (Munsell 1Y8.5/0.5)	Silky shade (Munsell 1Y8.5/0.5)	Silky shade (Munsell 1Y8.5/0.5)
Compressor	Type			Hermetic twin rotary compressor	Hermetic twin rotary compressor	Hermetic twin rotary compressor
	Motor output	kW		3.9x2 + 3.9x2 + 3.9x2	4.8x2 + 3.9x2 + 3.9x2	4.8x2 + 4.8x2 + 3.9x2
Fan unit	Fan			Propeller fan	Propeller fan	Propeller fan
	Motor output	kW		1.0 + 1.0 + 1.0	1.0 + 1.0 + 1.0	1.0 + 1.0 + 1.0
	Air volume	m3/h		12200 + 12200 + 12200	12200 + 12200 + 12200	12200 + 12200 + 12200
Max. external static pressure			Pa	50	50	50
Heat exchanger				Finned tube	Finned tube	Finned tube
Refrigerant	Name			R410A	R410A	R410A
	Charge	Heat pump	kg	11.5 + 11.5 + 11.5	11.5 + 11.5 + 11.5	11.5 + 11.5 + 11.5
High-pressure switch			Mpa	OFF:3.2 ON:4.15	OFF:3.2 ON:4.15	OFF:3.2 ON:4.15
Protective devices				(*3)	(*3)	(*3)
Power supply wiring		MCA (*4)	A	78.3	83.2	88.1
		MOCP (*5)	A	100.0	100.0	100.0
Piping connections	Gas	Type		Brazing	Brazing	Brazing
		Diameter	mm	41.3	41.3	41.3
	Liquid	Type		Flare	Flare	Flare
		Diameter	mm	22.2	22.2	22.2
	Balance	Type		Flare	Flare	Flare
		Diameter	mm	9.5	9.5	9.5
Max. number of connected indoor units				60	64	64
Sound pressure level		Cooling	dB(A)	64.0	64.5	64.5
		Heating	dB(A)	66.0	66.5	66.5
Operation temperature range		Cooling	CDB	-5 to 46	-5 to 46	-5 to 46
		Heating(*6)	CWB	-25 to 15.5	-25 to 15.5	-25 to 15.5

Note

(*1) Rated conditions Cooling : Indoor 27 degC Dry Bulb / 19 degC Wet Bulb, Outdoor 35 degC Dry Bulb.
Heating : Indoor 20 degC Dry Bulb, Outdoor 7 degC Dry Bulb / 6 degC Wet Bulb.
Based on equivalent piping length of 7.5 m and piping height difference of 0 m.

(*2) Voltage range : Units are suitable for use on electrical systems where voltage supplied to unit terminal is not below or above listed range limits.

(*3) Discharge temp. sensor / Suction temp. sensor / High-pressure sensor / Low-pressure sensor / High-pressure switch / P.C. board fuse

(*4) Select wire size base on the larger value of MCA.

MCA : Minimum Circuit Amps

(*5) MOCP : Maximum Overcurrent Protection (Amps)

(*6) Low ambient heating (-20degC or less) for extended periods of time is not allowed



High efficiency / Heating capacity priority model (50Hz/380~415V)

Model	Name	Heat pump		MMY-AP4226HT8P	MMY-AP4426HT8P	MMY-AP5426HT8P
	Combination	Heat pump		MMY-MAP1406HT8P	MMY-MAP1606HT8P	MMY-MAP2006HT8P
				MMY-MAP1406HT8P	MMY-MAP1406HT8P	MMY-MAP1406HT8P
Outdoor unit type				Inverter unit	Inverter unit	Inverter unit
Cooling capacity (*1)			kW	120.0	125.0	152.0
Heating capacity (*1)			kW	135.0	140.0	171.0
Capacity range			HP	42	44	54
Power supply				3N~ 50Hz 400V(380-415V)	3N~ 50Hz 400V(380-415V)	3N~ 50Hz 400V(380-415V)
Voltage range (*2)	Minimum	V		342	342	342
	Maximum	V		456	456	456
Electrical characteristic (*1)	Cooling	Running current	A	54.6	57.7	73.8
		Power input	kW	34.5	36.6	47.3
		EER	kW/kW	3.48	3.42	3.21
	Heating	Running current	A	50.4	53.2	67.4
		Power input	kW	31.8	33.7	43.6
		COP	kW/kW	4.25	4.15	3.92
	Starting current	A		Soft Start	Soft Start	Soft Start
Weight	Heat pump	kg		299 + 299 + 299	299 + 299 + 299	370 + 370 + 299
Colour				Silky shade (Munsell 1Y8.5/0.5)	Silky shade (Munsell 1Y8.5/0.5)	Silky shade (Munsell 1Y8.5/0.5)
Compressor	Type			Hermetic twin rotary compressor	Hermetic twin rotary compressor	Hermetic twin rotary compressor
	Motor output	kW		4.8x2 + 4.8x2 + 4.8x2	5.8x2 + 4.8x2 + 4.8x2	7.6x2 + 7.6x2 + 4.8x2
Fan unit	Fan			Propeller fan	Propeller fan	Propeller fan
	Motor output	kW		1.0 + 1.0 + 1.0	1.0 + 1.0 + 1.0	2.0 + 2.0 + 1.0
	Air volume	m3/h		12200 + 12200 + 12200	12600 + 12200 + 12200	17900 + 17900 + 12200
Max. external static pressure		Pa		50	50	60
Heat exchanger				Finned tube	Finned tube	Finned tube
Refrigerant	Name			R410A	R410A	R410A
	Charge	Heat pump	kg	11.5 + 11.5 + 11.5	11.5 + 11.5 + 11.5	11.5 + 11.5 + 11.5
High-pressure switch			Mpa	OFF:3.2 ON:4.15	OFF:3.2 ON:4.15	OFF:3.2 ON:4.15
Protective devices				(*3)	(*3)	(*3)
Power supply wiring	MCA (*4)	A		93.0	97.8	120.8
	MOCP (*5)	A		125.0	125.0	160.0
Piping connections	Gas	Type		Brazing	Brazing	Brazing
		Diameter	mm	41.3	41.3	41.3
	Liquid	Type		Flare	Flare	Flare
		Diameter	mm	22.2	22.2	22.2
	Balance	Type		Flare	Flare	Flare
		Diameter	mm	9.5	9.5	9.5
Max. number of connected indoor units				64	64	64
Sound pressure level	Cooling	dB(A)		65.0	65.5	65.5
	Heating	dB(A)		67.0	67.5	67.0
Operation temperature range	Cooling	CDB		-5 to 46	-5 to 46	-5 to 46
	Heating(*6)	CWB		-25 to 15.5	-25 to 15.5	-25 to 15.5

Note

(*1) Rated conditions Cooling : Indoor 27 degC Dry Bulb / 19 degC Wet Bulb, Outdoor 35 degC Dry Bulb.
Heating : Indoor 20 degC Dry Bulb, Outdoor 7 degC Dry Bulb / 6 degC Wet Bulb.
Based on equivalent piping length of 7.5 m and piping height difference of 0 m.

(*2) Voltage range : Units are suitable for use on electrical systems where voltage supplied to unit terminal is not below or above listed range limits.

(*3) Discharge temp. sensor / Suction temp. sensor / High-pressure sensor / Low-pressure sensor / High-pressure switch / P.C. board fuse

(*4) Select wire size base on the larger value of MCA.

MCA : Minimum Circuit Amps

(*5) MOCP : Maximum Overcurrent Protection (Amps)

(*6) Low ambient heating (-20degC or less) for extended periods of time is not allowed



Standard model (60Hz/380V)

Model name		Heat pump		MMY-MAP0806HT7P	MMY-MAP1006HT7P	MMY-MAP1206HT7P	MMY-MAP1406HT7P	
Outdoor unit type				Inverter unit	Inverter unit	Inverter unit	Inverter unit	
Cooling capacity (*1)		kW		22.4	28.0	33.5	40.0	
Heating capacity (*1)		kW		25.0	31.5	37.5	45.0	
Capacity range		HP		8	10	12	14	
Power supply				3N~ 60Hz 380V	3N~ 60Hz 380V	3N~ 60Hz 380V	3N~ 60Hz 380V	
Voltage range (*2)		Minimum	V	342	342	342	342	
		Maximum	V	418	418	418	418	
Electrical characteristic (*1)		Cooling	Running current	A	8.67	12.0	15.4	19.2
			Power input	kW	5.19	7.26	9.41	11.5
			EER	kW/kW	4.32	3.86	3.56	3.48
		Heating	Running current	A	8.98	11.70	15.10	17.70
			Power input	kW	5.38	7.08	9.24	10.6
			COP	kW/kW	4.65	4.45	4.06	4.25
Starting current		A		Soft Start	Soft Start	Soft Start	Soft Start	
Dimension		Height	mm	1800	1800	1800	1800	
		Width	mm	990	990	990	1210	
		Depth	mm	780	780	780	780	
Weight		Heat pump	kg	242	242	242	299	
Colour				Silky shade (Munsell 1Y8.5/0.5)	Silky shade (Munsell 1Y8.5/0.5)	Silky shade (Munsell 1Y8.5/0.5)	Silky shade (Munsell 1Y8.5/0.5)	
Compressor		Type		Hermetic twin rotary compressor	Hermetic twin rotary compressor	Hermetic twin rotary compressor	Hermetic twin rotary compressor	
		Motor output	kW	2.1x2	3.1x2	3.9x2	4.8x2	
Fan unit		Type		Propeller fan	Propeller fan	Propeller fan	Propeller fan	
		Motor output	kW	1.0	1.0	1.0	1.0	
		Air volume	m3/h	9700	9700	12200	12200	
Max. external static pressure		Pa		60	60	50	50	
Heat exchanger				Finned tube	Finned tube	Finned tube	Finned tube	
Refrigerant		Name		R410A	R410A	R410A	R410A	
		Charge	Heat pump	kg	11.5	11.5	11.5	11.5
High-pressure switch		Mpa		OFF:3.2 ON:4.15	OFF:3.2 ON:4.15	OFF:3.2 ON:4.15	OFF:3.2 ON:4.15	
Protective devices				(*3)	(*3)	(*3)	(*3)	
Power supply wiring		MCA (*4)	A	20.5	21.5	26.1	31.0	
		MOCP (*5)	A	25.0	25.0	32.0	40.0	
Piping connections		Gas	Type	Brazing	Brazing	Brazing	Brazing	
			Diameter	mm	19.1	22.2	28.6	28.6
		Liquid	Type	Flare	Flare	Flare	Flare	
			Diameter	mm	12.7	12.7	12.7	15.9
		Balance	Type	Flare	Flare	Flare	Flare	
			Diameter	mm	9.5	9.5	9.5	9.5
Max. number of connected indoor units				13	16	20	23	
Sound pressure level		Cooling	dB(A)	55.0	57.0	59.0	60.0	
		Heating	dB(A)	56.0	58.0	61.0	62.0	
Operation temperature range		Cooling	CDB	-5 to 46	-5 to 46	-5 to 46	-5 to 46	
		Heating(*6)	CWB	-25 to 15.5	-25 to 15.5	-25 to 15.5	-25 to 15.5	

Note

(*1) Rated conditions Cooling : Indoor 27 degC Dry Bulb / 19 degC Wet Bulb, Outdoor 35 degC Dry Bulb.
Heating : Indoor 20 degC Dry Bulb, Outdoor 7 degC Dry Bulb / 6 degC Wet Bulb.
Based on equivalent piping length of 7.5 m and piping height difference of 0 m.

(*2) Voltage range : Units are suitable for use on electrical systems where voltage supplied to unit terminal is not below or above listed range limits.

(*3) Discharge temp. sensor / Suction temp. sensor / High-pressure sensor / Low-pressure sensor / High-pressure switch / P.C. board fuse

(*4) Select wire size base on the larger value of MCA.

MCA : Minimum Circuit Amps

(*5) MOCP : Maximum Overcurrent Protection (Amps)

(*6) Low ambient heating (-20degC or less) for extended periods of time is not allowed



Standard model (60Hz/380V)

Model name		Heat pump		MMY-MAP1606HT7P	MMY-MAP1806HT7P	MMY-MAP2006HT7P	MMY-MAP2206HT7P	
Outdoor unit type				Inverter unit	Inverter unit	Inverter unit	Inverter unit	
Cooling capacity (*1)		kW		45.0	50.4	56.0	61.5	
Heating capacity (*1)		kW		50.0	56.0	63.0	64.0	
Capacity range		HP		16	18	20	22	
Power supply				3N~ 60Hz 380V	3N~ 60Hz 380V	3N~ 60Hz 380V	3N~ 60Hz 380V	
Voltage range (*2)		Minimum	V	342	342	342	342	
		Maximum	V	418	418	418	418	
Electrical characteristic (*1)		Cooling	Running current	A	22.5	23.1	29.2	33.9
			Power input	kW	13.6	14.0	17.9	21.0
			EER	kW/kW	3.31	3.60	3.13	2.93
		Heating	Running current	A	20.6	22.5	26.7	27.1
			Power input	kW	12.5	13.6	16.5	16.6
			COP	kW/kW	4.00	4.12	3.82	3.86
Starting current		A		Soft Start	Soft Start	Soft Start	Soft Start	
Dimension		Height	mm	1800	1800	1800	1800	
		Width	mm	1210	1600	1600	1600	
		Depth	mm	780	780	780	780	
Weight		Heat pump	kg	299	370	370	370	
Colour				Silky shade (Munsell 1Y8.5/0.5)	Silky shade (Munsell 1Y8.5/0.5)	Silky shade (Munsell 1Y8.5/0.5)	Silky shade (Munsell 1Y8.5/0.5)	
Compressor		Type		Hermetic twin rotary compressor	Hermetic twin rotary compressor	Hermetic twin rotary compressor	Hermetic twin rotary compressor	
		Motor output	kW	5.8x2	6.5x2	7.6x2	9.0x2	
Fan unit		Type		Propeller fan	Propeller fan	Propeller fan	Propeller fan	
		Motor output	kW	1.0	2.0	2.0	2.0	
		Air volume	m3/h	12600	17300	17900	18500	
Max. external static pressure			Pa	40	50	40	40	
Heat exchanger				Finned tube	Finned tube	Finned tube	Finned tube	
Refrigerant		Name		R410A	R410A	R410A	R410A	
		Charge	Heat pump	kg	11.5	11.5	11.5	11.5
High-pressure switch			Mpa	OFF:3.2 ON:4.15	OFF:3.2 ON:4.15	OFF:3.2 ON:4.15	OFF:3.2 ON:4.15	
Protective devices				(*3)	(*3)	(*3)	(*3)	
Power supply wiring		MCA (*4)	A	35.8	40.6	44.9	49.3	
		MOCP (*5)	A	40.0	50.0	63.0	63.0	
Piping connections		Gas	Type		Brazing	Brazing	Brazing	Brazing
			Diameter	mm	28.6	28.6	28.6	28.6
		Liquid	Type		Flare	Flare	Flare	Flare
			Diameter	mm	15.9	15.9	15.9	19.1
		Balance	Type		Flare	Flare	Flare	Flare
			Diameter	mm	9.5	9.5	9.5	9.5
Max. number of connected indoor units				27	30	33	37	
Sound pressure level		Cooling	dB(A)	62.0	60.0	61.0	61.0	
		Heating	dB(A)	64.0	61.0	62.0	62.0	
Operation temperature range		Cooling	CDB	-5 to 46	-5 to 46	-5 to 46	-5 to 46	
		Heating(*6)	CWB	-25 to 15.5	-25 to 15.5	-25 to 15.5	-25 to 15.5	

Note

(*1) Rated conditions Cooling : Indoor 27 degC Dry Bulb / 19 degC Wet Bulb, Outdoor 35 degC Dry Bulb.
Heating : Indoor 20 degC Dry Bulb, Outdoor 7 degC Dry Bulb / 6 degC Wet Bulb.
Based on equivalent piping length of 7.5 m and piping height difference of 0 m.

(*2) Voltage range : Units are suitable for use on electrical systems where voltage supplied to unit terminal is not below or above listed range limits.

(*3) Discharge temp. sensor / Suction temp. sensor / High-pressure sensor / Low-pressure sensor / High-pressure switch / P.C. board fuse

(*4) Select wire size base on the larger value of MCA.

MCA : Minimum Circuit Amps

(*5) MOCP : Maximum Overcurrent Protection (Amps)

(*6) Low ambient heating (-20degC or less) for extended periods of time is not allowed

Standard model (60Hz/380V)

Model	Name	Heat pump		MMY-AP2416HT7P	MMY-AP2616HT7P	MMY-AP2816HT7P	MMY-AP3016HT7P
	Combination	Heat pump		MMY-MAP1206HT7P	MMY-MAP1406HT7P	MMY-MAP1606HT7P	MMY-MAP1606HT7P
				MMY-MAP1206HT7P	MMY-MAP1206HT7P	MMY-MAP1206HT7P	MMY-MAP1406HT7P
Outdoor unit type				Inverter unit	Inverter unit	Inverter unit	Inverter unit
Cooling capacity (*1)			kW	67.0	73.5	78.5	85.0
Heating capacity (*1)			kW	75.0	82.5	87.5	95.0
Capacity range			HP	24	26	28	30
Power supply				3N~ 60Hz 380V	3N~ 60Hz 380V	3N~ 60Hz 380V	3N~ 60Hz 380V
Voltage range (*2)		Minimum	V	342	342	342	342
		Maximum	V	418	418	418	418
Electrical characteristic (*1)	Cooling	Running current	A	30.8	34.6	37.9	41.7
		Power input	kW	18.8	20.9	23.0	25.1
		EER	kW/kW	3.56	3.52	3.41	3.39
	Heating	Running current	A	30.2	32.8	35.7	38.3
		Power input	kW	18.5	19.8	21.7	23.1
		COP	kW/kW	4.06	4.16	4.02	4.11
	Starting current		A	Soft Start	Soft Start	Soft Start	Soft Start
Weight	Heat pump	kg	242 + 242	299 + 242	299 + 242	299 + 299	
Colour				Silky shade (Munsell 1Y8.5/0.5)	Silky shade (Munsell 1Y8.5/0.5)	Silky shade (Munsell 1Y8.5/0.5)	Silky shade (Munsell 1Y8.5/0.5)
Compressor	Type		Hermetic twin rotary compressor	Hermetic twin rotary compressor	Hermetic twin rotary compressor	Hermetic twin rotary compressor	
	Motor output	kW	3.9x2 +3.9x2	4.8x2 +3.9x2	5.8x2 +3.9x2	5.8x2 +4.8x2	
Fan unit	Fan		Propeller fan	Propeller fan	Propeller fan	Propeller fan	
	Motor output	kW	1.0 + 1.0	1.0 + 1.0	1.0 + 1.0	1.0 + 1.0	
	Air volume	m3/h	12200 +12200	12200 +12200	12600 +12200	12600 +12200	
Max. external static pressure			Pa	50	50	40	40
Heat exchanger				Finned tube	Finned tube	Finned tube	Finned tube
Refrigerant	Name		R410A	R410A	R410A	R410A	
	Charge	Heat pump	kg	11.5 + 11.5	11.5 + 11.5	11.5 + 11.5	11.5 + 11.5
High-pressure switch			Mpa	OFF:3.2 ON:4.15	OFF:3.2 ON:4.15	OFF:3.2 ON:4.15	OFF:3.2 ON:4.15
Protective devices				(*3)	(*3)	(*3)	(*3)
Power supply wiring		MCA (*4)	A	52.2	57.1	61.9	66.8
		MOCP (*5)	A	63.0	63.0	80.0	80.0
Piping connections	Gas	Type		Brazing	Brazing	Brazing	Brazing
		Diameter	mm	34.9	34.9	34.9	34.9
	Liquid	Type		Flare	Flare	Flare	Flare
		Diameter	mm	19.1	19.1	19.1	19.1
	Balance	Type		Flare	Flare	Flare	Flare
		Diameter	mm	9.5	9.5	9.5	9.5
Max. number of connected indoor units				40	43	47	50
Sound pressure level		Cooling	dB(A)	62.0	62.5	64.0	64.5
		Heating	dB(A)	64.0	64.5	66.0	66.5
Operation temperature range		Cooling	CDB	-5 to 46	-5 to 46	-5 to 46	-5 to 46
		Heating(*6)	CWB	-25 to 15.5	-25 to 15.5	-25 to 15.5	-25 to 15.5

Note
 (*1) Rated conditions Cooling : Indoor 27 degC Dry Bulb / 19 degC Wet Bulb, Outdoor 35 degC Dry Bulb.
 Heating : Indoor 20 degC Dry Bulb, Outdoor 7 degC Dry Bulb / 6 degC WetBulb.
 Based on equivalent piping length of 7.5 m and piping height difference of 0 m.

(*2) Voltage range : Units are suitable for use on electrical systems where voltage supplied to unit terminal is not below or above listed range limits.

(*3) Discharge temp. sensor / Suction temp. sensor / High-pressure sensor / Low-pressure sensor / High-pressure switch / P.C. board fuse

(*4) Select wire size base on the larger value of MCA.

MCA : Minimum Circuit Amps

(*5) MOCP : Maximum Overcurrent Protection (Amps)

(*6) Low ambient heating (-20degC or less) for extended periods of time is not allowed



Standard model (60Hz/380V)

Model	Name	Heat pump		MMY-AP3216HT7P	MMY-AP3416HT7P	MMY-AP3616HT7P	MMY-AP3816HT7P		
	Combination	Heat pump		MMY-MAP1606HT7P	MMY-MAP1806HT7P	MMY-MAP2006HT7P	MMY-MAP2206HT7P		
				MMY-MAP1606HT7P	MMY-MAP1606HT7P	MMY-MAP1606HT7P	MMY-MAP1606HT7P		
Outdoor unit type				Inverter unit	Inverter unit	Inverter unit	Inverter unit		
Cooling capacity (*1)			kW	90.0	95.4	101.0	106.5		
Heating capacity (*1)			kW	100.0	106.0	113.0	114.0		
Capacity range			HP	32	34	36	38		
Power supply				3N~ 60Hz 380V	3N~ 60Hz 380V	3N~ 60Hz 380V	3N~ 60Hz 380V		
Voltage range (*2)			Minimum	V	342	342	342		
			Maximum	V	418	418	418	418	
Electrical characteristic (*1)			Cooling	Running current	A	45.0	45.6		
				Power input	kW	27.2	27.6	31.5	34.6
				EER	kW/kW	3.31	3.46	3.21	3.08
			Heating	Running current	A	41.2	43.1	47.3	47.7
				Power input	kW	25.0	26.1	29.0	29.1
				COP	kW/kW	4.00	4.06	3.90	3.92
			Starting current	A	Soft Start	Soft Start	Soft Start	Soft Start	
Weight	Heat pump	kg	299 + 299	370 + 299	370 + 299	370 + 299			
Colour				Silky shade (Munsell 1Y8.5/0.5)	Silky shade (Munsell 1Y8.5/0.5)	Silky shade (Munsell 1Y8.5/0.5)	Silky shade (Munsell 1Y8.5/0.5)		
Compressor	Type			Hermetic twin rotary compressor	Hermetic twin rotary compressor	Hermetic twin rotary compressor	Hermetic twin rotary compressor		
	Motor output	kW		5.8x2 +5.8x2	6.5x2 +5.8x2	7.6x2 +5.8x2	9.0x2 +5.8x2		
Fan unit	Fan			Propeller fan	Propeller fan	Propeller fan	Propeller fan		
	Motor output	kW		1.0 + 1.0	2.0 + 1.0	2.0 + 1.0	2.0 + 1.0		
	Air volume	m3/h		12600 +12600	17300 +12600	17900 +12600	18500 +12600		
Max. external static pressure			Pa	40	40	40	40		
Heat exchanger				Finned tube	Finned tube	Finned tube	Finned tube		
Refrigerant	Name			R410A	R410A	R410A	R410A		
	Charge	Heat pump	kg	11.5 + 11.5	11.5 + 11.5	11.5 + 11.5	11.5 + 11.5		
High-pressure switch			Mpa	OFF:3.2 ON:4.15	OFF:3.2 ON:4.15	OFF:3.2 ON:4.15	OFF:3.2 ON:4.15		
Protective devices				(*3)	(*3)	(*3)	(*3)		
Power supply wiring			MCA (*4)	A	71.6	76.4	80.7		
			MOCP (*5)	A	80.0	100.0	100.0	100.0	
Piping connections			Gas	Type		Brazing	Brazing		
				Diameter	mm	34.9	34.9	41.3	41.3
			Liquid	Type		Flare	Flare	Flare	Flare
				Diameter	mm	19.1	19.1	22.2	22.2
			Balance	Type		Flare	Flare	Flare	Flare
				Diameter	mm	9.5	9.5	9.5	9.5
Max. number of connected indoor units				54	57	60	64		
Sound pressure level			Cooling	dB(A)	65.0	64.5	64.5		
			Heating	dB(A)	67.0	66.0	66.5	66.5	
Operation temperature range			Cooling	CDB	-5 to 46	-5 to 46	-5 to 46		
			Heating(*6)	CWB	-25 to 15.5	-25 to 15.5	-25 to 15.5	-25 to 15.5	

Note

(*1) Rated conditions Cooling : Indoor 27 degC Dry Bulb / 19 degC Wet Bulb, Outdoor 35 degC Dry Bulb.
Heating : Indoor 20 degC Dry Bulb, Outdoor 7 degC Dry Bulb / 6 degC Wet Bulb.
Based on equivalent piping length of 7.5 m and piping height difference of 0 m.

(*2) Voltage range : Units are suitable for use on electrical systems where voltage supplied to unit terminal is not below or above listed range limits.

(*3) Discharge temp. sensor / Suction temp. sensor / High-pressure sensor / Low-pressure sensor / High-pressure switch / P.C. board fuse

(*4) Select wire size base on the larger value of MCA.

MCA : Minimum Circuit Amps

(*5) MOCP : Maximum Overcurrent Protection (Amps)

(*6) Low ambient heating (-20degC or less) for extended periods of time is not allowed

Standard model (60Hz/380V)

Model	Name	Heat pump		MMY-AP4016HT7P	MMY-AP4216HT7P	MMY-AP4416HT7P
	Combination	Heat pump		MMY-MAP2006HT7P	MMY-MAP2206HT7P	MMY-MAP2206HT7P
Outdoor unit type				Inverter unit	Inverter unit	Inverter unit
Cooling capacity (*1)			kW	112.0	117.5	123.0
Heating capacity (*1)			kW	126.0	127.0	128.0
Capacity range			HP	40	42	44
Power supply				3N~ 60Hz 380V	3N~ 60Hz 380V	3N~ 60Hz 380V
Voltage range (*2)		Minimum	V	342	342	342
		Maximum	V	418	418	418
Electrical characteristic (*1)	Cooling	Running current	A	58.4	63.1	67.8
		Power input	kW	35.8	38.9	42.0
		EER	kW/kW	3.13	3.02	2.93
	Heating	Running current	A	53.4	53.8	54.2
		Power input	kW	33.0	33.1	33.2
		COP	kW/kW	3.82	3.84	3.86
	Starting current		A	Soft Start	Soft Start	Soft Start
Weight	Heat pump		kg	370 + 370	370 + 370	370 + 370
Colour				Silky shade (Munsell 1Y8.5/0.5)	Silky shade (Munsell 1Y8.5/0.5)	Silky shade (Munsell 1Y8.5/0.5)
Compressor	Type			Hermetic twin rotary compressor	Hermetic twin rotary compressor	Hermetic twin rotary compressor
	Motor output		kW	7.6x2 +7.6x2	9.0x2 +7.6x2	9.0x2 +9.0x2
Fan unit	Fan			Propeller fan	Propeller fan	Propeller fan
	Motor output		kW	2.0 + 2.0	2.0 + 2.0	2.0 + 2.0
	Air volume		m3/h	17900 +17900	18500 +17900	18500 +18500
Max. external static pressure			Pa	40	40	40
Heat exchanger				Finned tube	Finned tube	Finned tube
Refrigerant	Name			R410A	R410A	R410A
	Charge	Heat pump	kg	11.5 + 11.5	11.5 + 11.5	11.5 + 11.5
High-pressure switch			Mpa	OFF:3.2 ON:4.15	OFF:3.2 ON:4.15	OFF:3.2 ON:4.15
Protective devices				(*3)	(*3)	(*3)
Power supply wiring		MCA (*4)	A	89.8	94.2	98.6
		MOCP (*5)	A	100.0	125.0	125.0
Piping connections	Gas	Type		Brazing	Brazing	Brazing
		Diameter	mm	41.3	41.3	41.3
	Liquid	Type		Flare	Flare	Flare
		Diameter	mm	22.2	22.2	22.2
	Balance	Type		Flare	Flare	Flare
		Diameter	mm	9.5	9.5	9.5
Max. number of connected indoor units				64	64	64
Sound pressure level		Cooling	dB(A)	64.0	64.0	64.0
		Heating	dB(A)	65.0	65.0	65.0
Operation temperature range		Cooling	CDB	-5 to 46	-5 to 46	-5 to 46
		Heating(*6)	CWB	-25 to 15.5	-25 to 15.5	-25 to 15.5

Note

(*1) Rated conditions Cooling : Indoor 27 degC Dry Bulb / 19 degC Wet Bulb, Outdoor 35 degC Dry Bulb.

Heating : Indoor 20 degC Dry Bulb, Outdoor 7 degC Dry Bulb / 6 degC Wet Bulb.

Based on equivalent piping length of 7.5 m and piping height difference of 0 m.

(*2) Voltage range : Units are suitable for use on electrical systems where voltage supplied to unit terminal is not below or above listed range limits.

(*3) Discharge temp. sensor / Suction temp. sensor / High-pressure sensor / Low-pressure sensor / High-pressure switch / P.C. board fuse

(*4) Select wire size base on the larger value of MCA.

MCA : Minimum Circuit Amps

(*5) MOCP : Maximum Overcurrent Protection (Amps)

(*6) Low ambient heating (-20degC or less) for extended periods of time is not allowed

Standard model (60Hz/380V)

Model	Name	Heat pump		MMY-AP4616HT7P	MMY-AP4816HT7P	MMY-AP5016HT7P
	Combination	Heat pump		MMY-MAP1606HT7P	MMY-MAP1606HT7P	MMY-MAP1806HT7P
				MMY-MAP1606HT7P	MMY-MAP1606HT7P	MMY-MAP1606HT7P
				MMY-MAP1406HT7P	MMY-MAP1606HT7P	MMY-MAP1606HT7P
Outdoor unit type				Inverter unit	Inverter unit	Inverter unit
Cooling capacity (*1)			kW	130.0	135.0	140.4
Heating capacity (*1)			kW	145.0	150.0	156.0
Capacity range			HP	46	48	50
Power supply				3N~ 60Hz 380V	3N~ 60Hz 380V	3N~ 60Hz 380V
Voltage range (*2)		Minimum	V	342	342	342
		Maximum	V	418	418	418
Electrical characteristic (*1)	Cooling	Running current	A	64.2	67.5	68.1
		Power input	kW	38.7	40.8	41.2
		EER	kW/kW	3.36	3.31	3.41
	Heating	Running current	A	58.9	61.8	63.7
		Power input	kW	35.6	37.5	38.6
		COP	kW/kW	4.07	4.00	4.04
Starting current		A	Soft Start		Soft Start	
Weight	Heat pump		kg	299 + 299 + 299	299 + 299 + 299	370 + 299 + 299
Colour				Silky shade (Munsell 1Y8.5/0.5)	Silky shade (Munsell 1Y8.5/0.5)	Silky shade (Munsell 1Y8.5/0.5)
Compressor	Type			Hermetic twin rotary compressor	Hermetic twin rotary compressor	Hermetic twin rotary compressor
	Motor output		kW	5.8x2 +5.8x2 +4.8x2	5.8x2 +5.8x2 +5.8x2	6.5x2 +5.8x2 +5.8x2
Fan unit	Fan			Propeller fan	Propeller fan	Propeller fan
	Motor output		kW	1.0 + 1.0 + 1.0	1.0 + 1.0 + 1.0	2.0 + 1.0 + 1.0
	Air volume		m3/h	12600 +12600 +12200	12600 +12600 +12600	17300 +12600 +12600
Max. external static pressure			Pa	40	40	40
Heat exchanger				Finned tube	Finned tube	Finned tube
Refrigerant	Name			R410A	R410A	R410A
	Charge	Heat pump	kg	11.5 + 11.5 + 11.5	11.5 + 11.5 + 11.5	11.5 + 11.5 + 11.5
High-pressure switch			Mpa	OFF:3.2 ON:4.15	OFF:3.2 ON:4.15	OFF:3.2 ON:4.15
Protective devices				(*3)	(*3)	(*3)
Power supply wiring		MCA (*4)	A	102.6	107.4	112.2
		MOCP (*5)	A	125.0	125.0	125.0
Piping connections	Gas	Type		Brazing	Brazing	Brazing
		Diameter	mm	41.3	41.3	41.3
	Liquid	Type		Flare	Flare	Flare
		Diameter	mm	22.2	22.2	22.2
	Balance	Type		Flare	Flare	Flare
		Diameter	mm	9.5	9.5	9.5
Max. number of connected indoor units				64	64	64
Sound pressure level		Cooling	dB(A)	66.5	67.0	66.5
		Heating	dB(A)	68.5	69.0	68.0
Operation temperature range		Cooling	CDB	-5 to 46	-5 to 46	-5 to 46
		Heating(*6)	CWB	-25 to 15.5	-25 to 15.5	-25 to 15.5

Note

(*1) Rated conditions Cooling : Indoor 27 degC Dry Bulb / 19 degC Wet Bulb, Outdoor 35 degC Dry Bulb.
Heating : Indoor 20 degC Dry Bulb, Outdoor 7 degC Dry Bulb / 6 degC Wet Bulb.
Based on equivalent piping length of 7.5 m and piping height difference of 0 m.

(*2) Voltage range : Units are suitable for use on electrical systems where voltage supplied to unit terminal is not below or above listed range limits.

(*3) Discharge temp. sensor / Suction temp. sensor / High-pressure sensor / Low-pressure sensor / High-pressure switch / P.C. board fuse

(*4) Select wire size base on the larger value of MCA.

MCA : Minimum Circuit Amps

(*5) MOCP : Maximum Overcurrent Protection (Amps)

(*6) Low ambient heating (-20degC or less) for extended periods of time is not allowed

Standard model (60Hz/380V)

Model	Name		Heat pump	MMY-AP5216HT7P	MMY-AP5416HT7P	MMY-AP5616HT7P
	Combination	Heat pump		MMY-MAP2006HT7P	MMY-MAP2206HT7P	MMY-MAP2006HT7P
				MMY-MAP1606HT7P	MMY-MAP1606HT7P	MMY-MAP2006HT7P
				MMY-MAP1606HT7P	MMY-MAP1606HT7P	MMY-MAP1606HT7P
Outdoor unit type			Inverter unit	Inverter unit	Inverter unit	
Cooling capacity (*1)			kW	146.0	151.5	157.0
Heating capacity (*1)			kW	163.0	164.0	176.0
Capacity range			HP	52	54	56
Power supply				3N~ 60Hz 380V	3N~ 60Hz 380V	3N~ 60Hz 380V
Voltage range (*2)			Minimum	V	342	342
			Maximum	V	418	418
Electrical characteristic (*1)	Cooling	Running current	A	74.2	78.9	80.9
		Power input	kW	45.1	48.2	49.4
		EER	kW/kW	3.24	3.14	3.18
	Heating	Running current	A	67.9	68.3	74.0
		Power input	kW	41.5	41.6	45.5
		COP	kW/kW	3.93	3.94	3.87
	Starting current		A	Soft Start	Soft Start	Soft Start
Weight	Heat pump		kg	370 + 299 + 299	370 + 299 + 299	370 + 370 + 299
Colour				Silky shade (Munsell 1Y8.5/0.5)	Silky shade (Munsell 1Y8.5/0.5)	Silky shade (Munsell 1Y8.5/0.5)
Compressor	Type			Hermetic twin rotary compressor	Hermetic twin rotary compressor	Hermetic twin rotary compressor
	Motor output		kW	7.6x2 +5.8x2 +5.8x2	9.0x2 +5.8x2 +5.8x2	7.6x2 +7.6x2 +5.8x2
Fan unit	Fan			Propeller fan	Propeller fan	Propeller fan
	Motor output		kW	2.0 + 1.0 + 1.0	2.0 + 1.0 + 1.0	2.0 + 2.0 + 1.0
	Air volume		m ³ /h	17900 +12600 +12600	18500 +12600 +12600	17900 +17900 +12600
Max. external static pressure			Pa	40	40	40
Heat exchanger				Finned tube	Finned tube	Finned tube
Refrigerant	Name			R410A	R410A	R410A
	Charge	Heat pump	kg	11.5 + 11.5 + 11.5	11.5 + 11.5 + 11.5	11.5 + 11.5 + 11.5
High-pressure switch			Mpa	OFF:3.2 ON:4.15	OFF:3.2 ON:4.15	OFF:3.2 ON:4.15
Protective devices				(*3)	(*3)	(*3)
Power supply wiring			MCA (*4)	A	116.5	120.9
			MOCP (*5)	A	160.0	160.0
Piping connections	Gas	Type		Brazing	Brazing	Brazing
		Diameter	mm	41.3	41.3	41.3
	Liquid	Type		Flare	Flare	Flare
		Diameter	mm	22.2	22.2	22.2
	Balance	Type		Flare	Flare	Flare
		Diameter	mm	9.5	9.5	9.5
Max. number of connected indoor units				64	64	64
Sound pressure level			Cooling	dB(A)	66.5	66.5
			Heating	dB(A)	68.5	68.5
Operation temperature range			Cooling	CDB	-5 to 46	-5 to 46
			Heating(*6)	CWB	-25 to 15.5	-25 to 15.5

Note

(*1) Rated conditions Cooling : Indoor 27 degC Dry Bulb / 19 degC Wet Bulb, Outdoor 35 degC Dry Bulb.

Heating : Indoor 20 degC Dry Bulb, Outdoor 7 degC Dry Bulb / 6 degC Wet Bulb.

Based on equivalent piping length of 7.5 m and piping height difference of 0 m.

(*2) Voltage range : Units are suitable for use on electrical systems where voltage supplied to unit terminal is not below or above listed range limits.

(*3) Discharge temp. sensor / Suction temp. sensor / High-pressure sensor / Low-pressure sensor / High-pressure switch / P.C. board fuse

(*4) Select wire size base on the larger value of MCA.

MCA : Minimum Circuit Amps

(*5) MOCP : Maximum Overcurrent Protection (Amps)

(*6) Low ambient heating (-20degC or less) for extended periods of time is not allowed

Standard model (60Hz/380V)

Model	Name	Heat pump		MMY-AP5816HT7P	MMY-AP6016HT7P
	Combination	Heat pump		MMY-MAP2206HT7P	MMY-MAP2206HT7P
				MMY-MAP2006HT7P	MMY-MAP2206HT7P
				MMY-MAP1606HT7P	MMY-MAP1606HT7P
Outdoor unit type				Inverter unit	Inverter unit
Cooling capacity (*1)			kW	162.5	168.0
Heating capacity (*1)			kW	177.0	178.0
Capacity range			HP	58	60
Power supply				3N~ 60Hz 380V	3N~ 60Hz 380V
Voltage range (*2)		Minimum	V	342	342
		Maximum	V	418	418
Electrical characteristic (*1)	Cooling	Running current	A	85.6	90.3
		Power input	kW	52.5	55.6
		EER	kW/kW	3.10	3.02
	Heating	Running current	A	74.4	74.8
		Power input	kW	45.6	45.7
		COP	kW/kW	3.88	3.89
Starting current		A	Soft Start	Soft Start	
Weight	Heat pump	kg	370 + 370 + 299	370 + 370 + 299	
Colour				Silky shade (Munsell 1Y8.5/0.5)	Silky shade (Munsell 1Y8.5/0.5)
Compressor	Type			Hermetic twin rotary compressor	Hermetic twin rotary compressor
	Motor output	kW		9.0x2 +7.6x2 +5.8x2	9.0x2 +9.0x2 +5.8x2
Fan unit	Fan			Propeller fan	Propeller fan
	Motor output	kW		2.0 + 2.0 + 1.0	2.0 + 2.0 + 1.0
	Air volume	m3/h		18500 +17900 +12600	18500 +18500 +12600
Max. external static pressure			Pa	40	40
Heat exchanger				Finned tube	Finned tube
Refrigerant	Name			R410A	R410A
	Charge	Heat pump	kg	11.5 + 11.5 + 11.5	11.5 + 11.5 + 11.5
High-pressure switch			Mpa	OFF:3.2 ON:4.15	OFF:3.2 ON:4.15
Protective devices				(*3)	(*3)
Power supply wiring		MCA (*4)	A	130.0	134.4
		MOCP (*5)	A	160.0	160.0
Piping connections	Gas	Type		Brazing	Brazing
		Diameter	mm	41.3	41.3
	Liquid	Type		Flare	Flare
		Diameter	mm	22.2	22.2
	Balance	Type		Flare	Flare
		Diameter	mm	9.5	9.5
Max. number of connected indoor units				64	64
Sound pressure level		Cooling	dB(A)	66.5	66.5
		Heating	dB(A)	67.5	67.5
Operation temperature range		Cooling	CDB	-5 to 46	-5 to 46
		Heating(*6)	CWB	-25 to 15.5	-25 to 15.5

Note

(*1) Rated conditions Cooling : Indoor 27 degC Dry Bulb / 19 degC Wet Bulb, Outdoor 35 degC Dry Bulb.
Heating : Indoor 20 degC Dry Bulb, Outdoor 7 degC Dry Bulb / 6 degC Wet Bulb.
Based on equivalent piping length of 7.5 m and piping height difference of 0 m.

(*2) Voltage range : Units are suitable for use on electrical systems where voltage supplied to unit terminal is not below or above listed range limits.

(*3) Discharge temp. sensor / Suction temp. sensor / High-pressure sensor / Low-pressure sensor / High-pressure switch / P.C. board fuse

(*4) Select wire size base on the larger value of MCA.

MCA : Minimum Circuit Amps

(*5) MOCP : Maximum Overcurrent Protection (Amps)

(*6) Low ambient heating (-20degC or less) for extended periods of time is not allowed



High efficiency / Heating capacity priority model (60Hz/380V)

Model	Name	Heat pump		MMY-AP2026HT7P	MMY-AP2226HT7P
	Combination	Heat pump		MMY-MAP1006HT7P	MMY-MAP1206HT7P
				MMY-MAP1006HT7P	MMY-MAP1006HT7P
Outdoor unit type				Inverter unit	Inverter unit
Cooling capacity (*1)			kW	56.0	61.5
Heating capacity (*1)			kW	63.0	69.0
Capacity range			HP	20	22
Power supply				3N~ 60Hz 380V	3N~ 60Hz 380V
Voltage range (*2)		Minimum	V	342	342
		Maximum	V	418	418
Electrical characteristic (*1)	Cooling	Running current	A	24.0	27.4
		Power input	kW	14.5	16.7
		EER	kW/kW	3.86	3.69
	Heating	Running current	A	23.4	26.8
		Power input	kW	14.2	16.3
		COP	kW/kW	4.45	4.23
Starting current		A	Soft Start	Soft Start	
Weight	Heat pump		kg	242 + 242	242 + 242
Colour				Silky shade (Munsell 1Y8.5/0.5)	Silky shade (Munsell 1Y8.5/0.5)
Compressor	Type			Hermetic twin rotary compressor	Hermetic twin rotary compressor
	Motor output		kW	3.1x2 +3.1x2	3.9x2 +3.1x2
Fan unit	Fan			Propeller fan	Propeller fan
	Motor output		kW	1.0 + 1.0	1.0 + 1.0
	Air volume		m3/h	9700 +9700	12200 +9700
Max. external static pressure			Pa	60	50
Heat exchanger				Finned tube	Finned tube
Refrigerant	Name			R410A	R410A
	Charge	Heat pump	kg	11.5 + 11.5	11.5 + 11.5
High-pressure switch			Mpa	OFF:3.2 ON:4.15	OFF:3.2 ON:4.15
Protective devices				(*3)	(*3)
Power supply wiring		MCA (*4)	A	43.0	47.6
		MOCP (*5)	A	63.0	63.0
Piping connections	Gas	Type		Brazing	Brazing
		Diameter	mm	28.6	28.6
	Liquid	Type		Flare	Flare
		Diameter	mm	15.9	19.1
	Balance	Type		Flare	Flare
		Diameter	mm	9.5	9.5
Max. number of connected indoor units				33	37
Sound pressure level		Cooling	dB(A)	60.0	61.5
		Heating	dB(A)	61.0	63.0
Operation temperature range		Cooling	CDB	-5 to 46	-5 to 46
		Heating(*6)	CWB	-25 to 15.5	-25 to 15.5

Note

(*1) Rated conditions Cooling : Indoor 27 degC Dry Bulb / 19 degC Wet Bulb, Outdoor 35 degC Dry Bulb.
Heating : Indoor 20 degC Dry Bulb, Outdoor 7 degC Dry Bulb / 6 degC Wet Bulb.
Based on equivalent piping length of 7.5 m and piping height difference of 0 m.

(*2) Voltage range : Units are suitable for use on electrical systems where voltage supplied to unit terminal is not below or above listed range limits.

(*3) Discharge temp. sensor / Suction temp. sensor / High-pressure sensor / Low-pressure sensor / High-pressure switch / P.C. board fuse

(*4) Select wire size base on the larger value of MCA.

MCA : Minimum Circuit Amps

(*5) MOCP : Maximum Overcurrent Protection (Amps)

(*6) Low ambient heating (-20degC or less) for extended periods of time is not allowed



High efficiency / Heating capacity priority model (60Hz/380V)

Model	Name		Heat pump	MMY-AP3626HT7P	MMY-AP3826HT7P	MMY-AP4026HT7P
	Combination	Heat pump		MMY-MAP1206HT7P	MMY-MAP1406HT7P	MMY-MAP1406HT7P
				MMY-MAP1206HT7P	MMY-MAP1206HT7P	MMY-MAP1406HT7P
				MMY-MAP1206HT7P	MMY-MAP1206HT7P	MMY-MAP1206HT7P
Outdoor unit type				Inverter unit	Inverter unit	Inverter unit
Cooling capacity (*1)			kW	100.5	107.0	113.5
Heating capacity (*1)			kW	112.5	120.0	127.5
Capacity range			HP	36	38	40
Power supply				3N~ 60Hz 380V	3N~ 60Hz 380V	3N~ 60Hz 380V
Voltage range (*2)			Minimum	V	342	342
			Maximum	V	418	418
Electrical characteristic (*1)	Cooling	Running current	A	46.2	50.0	53.8
		Power input	kW	28.2	30.3	32.4
		EER	kW/kW	3.56	3.53	3.50
	Heating	Running current	A	45.3	47.9	50.5
		Power input	kW	27.7	29.1	30.4
		COP	kW/kW	4.06	4.13	4.19
Starting current			A	Soft Start	Soft Start	Soft Start
Weight	Heat pump		kg	242 + 242 + 242	299 + 242 + 242	299 + 299 + 242
Colour				Silky shade (Munsell 1Y8.5/0.5)	Silky shade (Munsell 1Y8.5/0.5)	Silky shade (Munsell 1Y8.5/0.5)
Compressor	Type			Hermetic twin rotary compressor	Hermetic twin rotary compressor	Hermetic twin rotary compressor
	Motor output		kW	3.9x2 + 3.9x2 + 3.9x2	4.8x2 + 3.9x2 + 3.9x2	4.8x2 + 4.8x2 + 3.9x2
Fan unit	Fan			Propeller fan	Propeller fan	Propeller fan
	Motor output		kW	1.0 + 1.0 + 1.0	1.0 + 1.0 + 1.0	1.0 + 1.0 + 1.0
	Air volume		m3/h	12200 + 12200 + 12200	12200 + 12200 + 12200	12200 + 12200 + 12200
Max. external static pressure			Pa	50	50	50
Heat exchanger				Finned tube	Finned tube	Finned tube
Refrigerant	Name			R410A	R410A	R410A
	Charge	Heat pump	kg	11.5 + 11.5 + 11.5	11.5 + 11.5 + 11.5	11.5 + 11.5 + 11.5
High-pressure switch			Mpa	OFF:3.2 ON:4.15	OFF:3.2 ON:4.15	OFF:3.2 ON:4.15
Protective devices				(*3)	(*3)	(*3)
Power supply wiring			MCA (*4)	A	78.3	83.2
			MOCP (*5)	A	100.0	100.0
Piping connections	Gas	Type		Brazing	Brazing	Brazing
		Diameter	mm	41.3	41.3	41.3
	Liquid	Type		Flare	Flare	Flare
		Diameter	mm	22.2	22.2	22.2
	Balance	Type		Flare	Flare	Flare
		Diameter	mm	9.5	9.5	9.5
Max. number of connected indoor units				60	64	64
Sound pressure level			Cooling	dB(A)	64.0	64.5
			Heating	dB(A)	66.0	66.5
Operation temperature range			Cooling	CDB	-5 to 46	-5 to 46
			Heating(*6)	CWB	-25 to 15.5	-25 to 15.5

Note

(*1) Rated conditions Cooling : Indoor 27 degC Dry Bulb / 19 degC Wet Bulb, Outdoor 35 degC Dry Bulb.

Heating : Indoor 20 degC Dry Bulb, Outdoor 7 degC Dry Bulb / 6 degC Wet Bulb.

Based on equivalent piping length of 7.5 m and piping height difference of 0 m.

(*2) Voltage range : Units are suitable for use on electrical systems where voltage supplied to unit terminal is not below or above listed range limits.

(*3) Discharge temp. sensor / Suction temp. sensor / High-pressure sensor / Low-pressure sensor / High-pressure switch / P.C. board fuse

(*4) Select wire size base on the larger value of MCA.

MCA : Minimum Circuit Amps

(*5) MOCP : Maximum Overcurrent Protection (Amps)

(*6) Low ambient heating (-20degC or less) for extended periods of time is not allowed



High efficiency / Heating capacity priority model (60Hz/380V)

Model	Name		Heat pump	MMY-AP4226HT7P	MMY-AP4426HT7P	MMY-AP5426HT7P
	Combination	Heat pump		MMY-MAP1406HT7P	MMY-MAP1606HT7P	MMY-MAP2006HT7P
		Heat pump		MMY-MAP1406HT7P	MMY-MAP1406HT7P	MMY-MAP2006HT7P
		Heat pump		MMY-MAP1406HT7P	MMY-MAP1406HT7P	MMY-MAP1406HT7P
Outdoor unit type				Inverter unit	Inverter unit	Inverter unit
Cooling capacity (*1)			kW	120.0	125.0	152.0
Heating capacity (*1)			kW	135.0	140.0	171.0
Capacity range			HP	42	44	54
Power supply				3N~ 60Hz 380V	3N~ 60Hz 380V	3N~ 60Hz 380V
Voltage range (*2)			Minimum	V	342	342
			Maximum	V	418	418
Electrical characteristic (*1)	Cooling	Running current	A	57.6	60.9	77.6
		Power input	kW	34.5	36.6	47.3
		EER	kW/kW	3.48	3.42	3.21
	Heating	Running current	A	53.1	56.0	71.1
		Power input	kW	31.8	33.7	43.6
		COP	kW/kW	4.25	4.15	3.92
Starting current			A	Soft Start	Soft Start	Soft Start
Weight	Heat pump		kg	299 + 299 + 299	299 + 299 + 299	370 + 370 + 299
Colour				Silky shade (Munsell 1Y8.5/0.5)	Silky shade (Munsell 1Y8.5/0.5)	Silky shade (Munsell 1Y8.5/0.5)
Compressor	Type			Hermetic twin rotary compressor	Hermetic twin rotary compressor	Hermetic twin rotary compressor
	Motor output		kW	4.8x2 +4.8x2 +4.8x2	5.8x2 +4.8x2 +4.8x2	7.6x2 +7.6x2 +4.8x2
Fan unit	Fan			Propeller fan	Propeller fan	Propeller fan
	Motor output		kW	1.0 + 1.0 + 1.0	1.0 + 1.0 + 1.0	2.0 + 2.0 + 1.0
	Air volume		m3/h	12200 +12200 +12200	12600 +12200 +12200	17900 +17900 +12200
Max. external static pressure			Pa	50	50	60
Heat exchanger				Finned tube	Finned tube	Finned tube
Refrigerant	Name			R410A	R410A	R410A
	Charge	Heat pump	kg	11.5 + 11.5 + 11.5	11.5 + 11.5 + 11.5	11.5 + 11.5 + 11.5
High-pressure switch			Mpa	OFF:3.2 ON:4.15	OFF:3.2 ON:4.15	OFF:3.2 ON:4.15
Protective devices				(*3)	(*3)	(*3)
Power supply wiring			MCA (*4)	A	93.0	120.8
			MOCP (*5)	A	125.0	160.0
Piping connections	Gas	Type		Brazing	Brazing	Brazing
		Diameter	mm	41.3	41.3	41.3
	Liquid	Type		Flare	Flare	Flare
		Diameter	mm	22.2	22.2	22.2
	Balance	Type		Flare	Flare	Flare
		Diameter	mm	9.5	9.5	9.5
Max. number of connected indoor units				64	64	64
Sound pressure level			Cooling	dB(A)	65.0	65.5
			Heating	dB(A)	67.0	67.5
Operation temperature range			Cooling	CDB	-5 to 46	-5 to 46
			Heating(*6)	CWB	-25 to 15.5	-25 to 15.5

Note
 (*1) Rated conditions Cooling : Indoor 27 degC Dry Bulb / 19 degC Wet Bulb, Outdoor 35 degC Dry Bulb.
 Heating : Indoor 20 degC Dry Bulb, Outdoor 7 degC Dry Bulb / 6 degC Wet Bulb.
 Based on equivalent piping length of 7.5 m and piping height difference of 0 m.
 (*2) Voltage range : Units are suitable for use on electrical systems where voltage supplied to unit terminal is not below or above listed range limits.
 (*3) Discharge temp. sensor / Suction temp. sensor / High-pressure sensor / Low-pressure sensor / High-pressure switch / P.C. board fuse
 (*4) Select wire size base on the larger value of MCA.
 MCA : Minimum Circuit Amps
 (*5) MOCP : Maximum Overcurrent Protection (Amps)
 (*6) Low ambient heating (-20degC or less) for extended periods of time is not allowed

5-2. Dimensional drawing

Single unit

Model : MMY-MAP0806HT8P, MAP1006HT8P, MAP1206HT8P

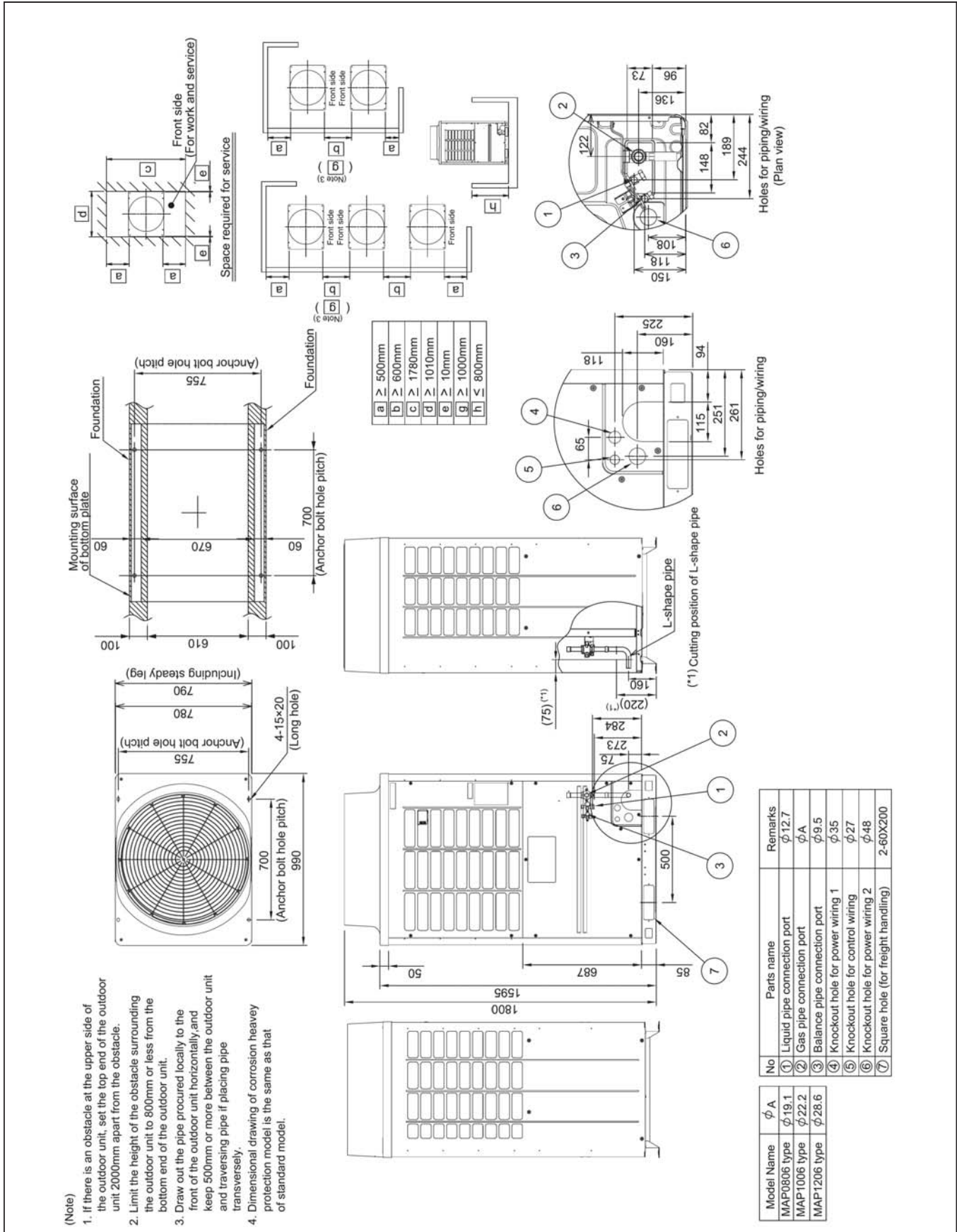

Single unit

Model : MMY-MAP1406HT8P, MAP1606HT8P

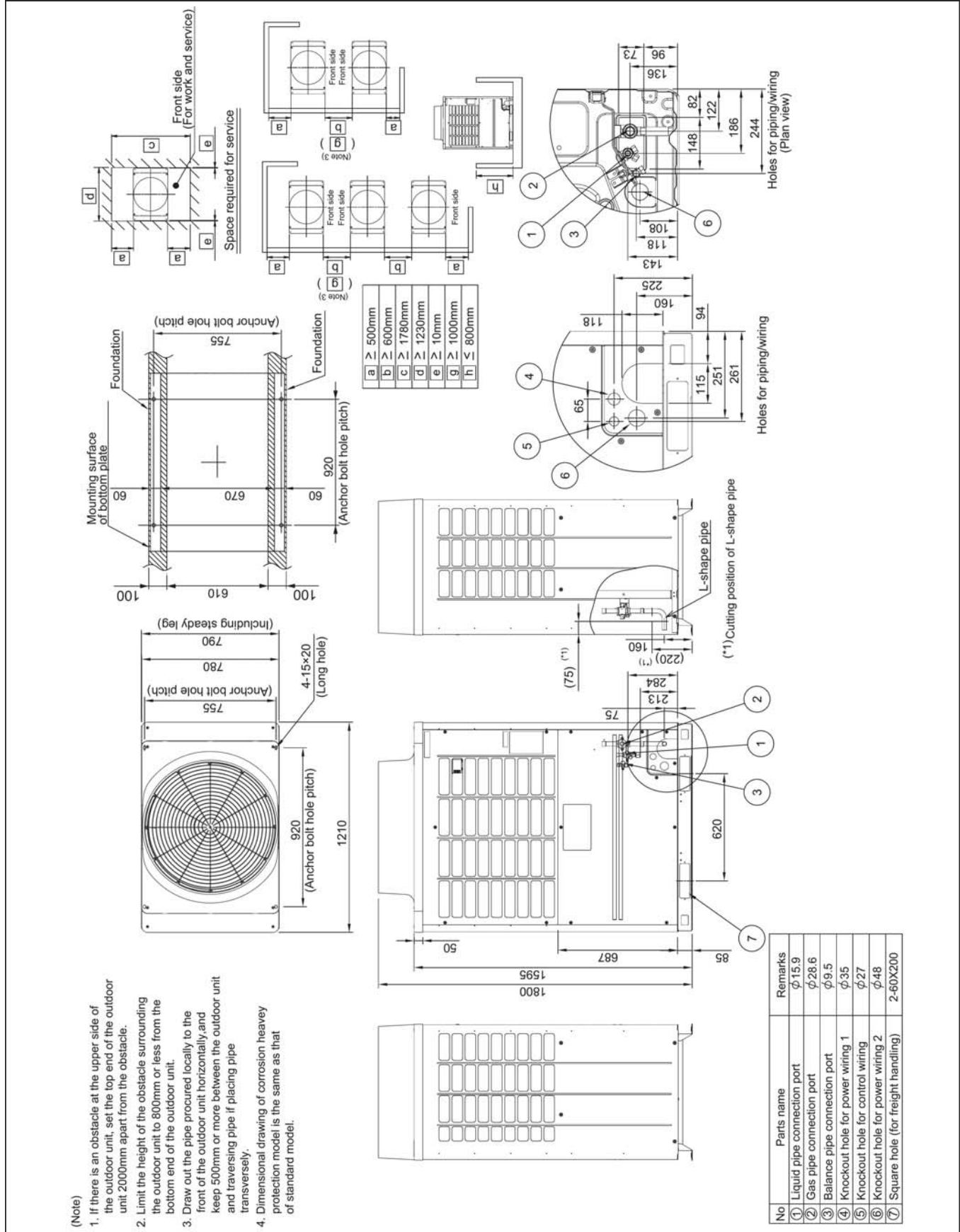

(Note)

1. If there is an obstacle at the upper side of the outdoor unit, set the top end of the outdoor unit 2000mm apart from the obstacle.
2. Limit the height of the obstacle surrounding the outdoor unit to 800mm or less from the bottom end of the outdoor unit.
3. Draw out the pipe procured locally to the front of the outdoor unit horizontally, and keep 500mm or more between the outdoor unit and traversing pipe if placing pipe transversely.
4. Dimensional drawing of corrosion heavy protection model is the same as that of standard model.

Single unit

Model : MMY-MAP1806HT8P, MAP2006HT8P, MAP2206HT8P

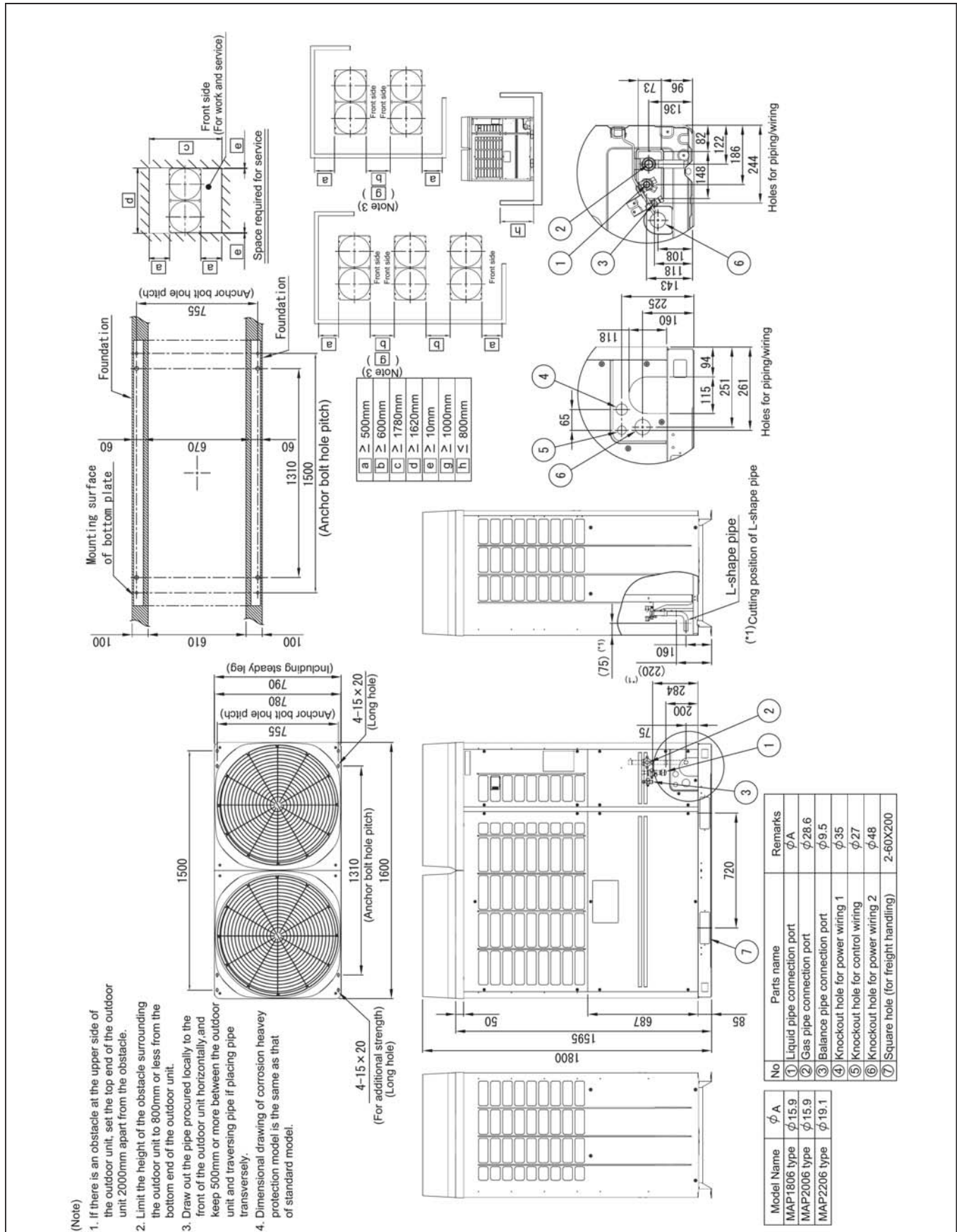

Combination

Model	Outdoor unit	
	(1) Header unit	(2) Follower unit
MMY-AP2026HT8P	MMY-MAP1006HT8P	MMY-MAP1006HT8P
MMY-AP2226HT8P	MMY-MAP1206HT8P	MMY-MAP1006HT8P
MMY-AP2416HT8P	MMY-MAP1206HT8P	MMY-MAP1206HT8P

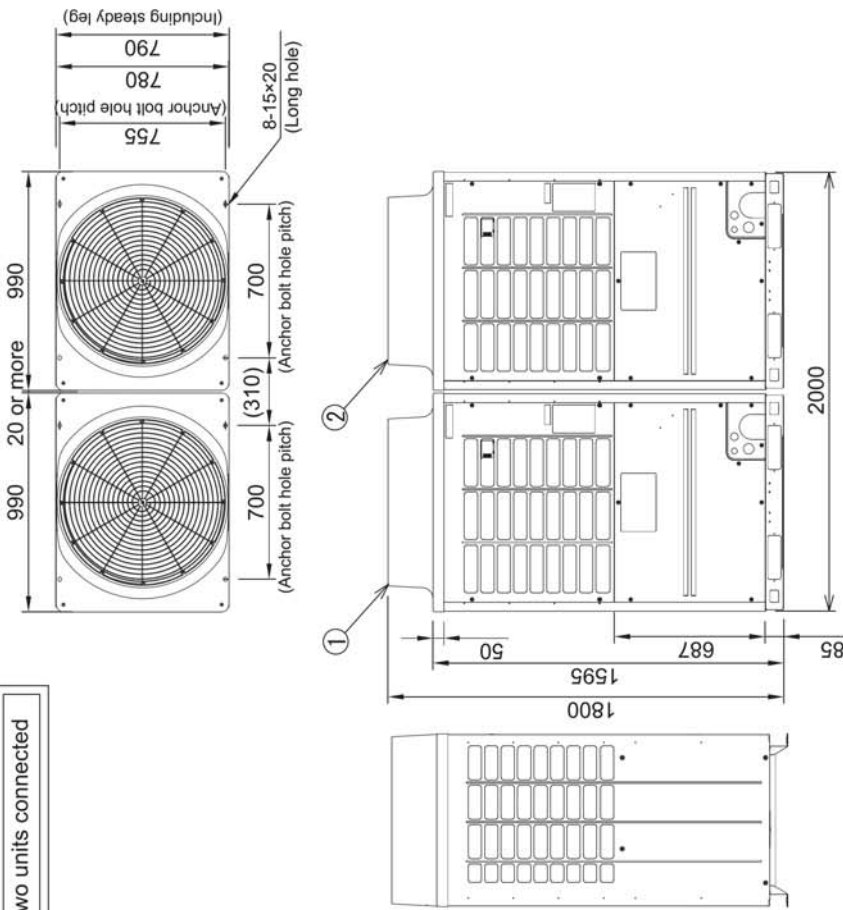
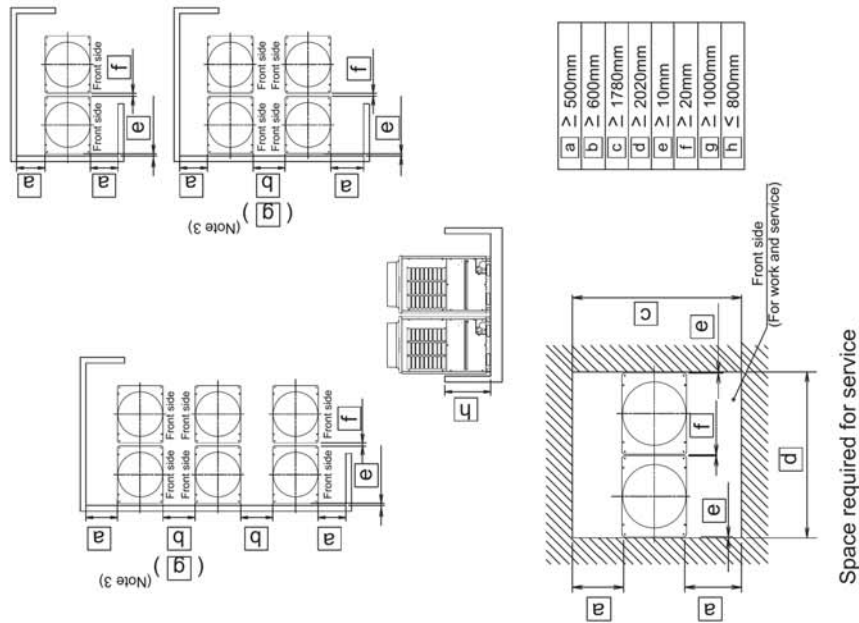

- (Note)
1. If there is an obstacle at the upper side of the outdoor unit, set the top end of the outdoor unit 2000mm apart from the obstacle.
 2. Limit the height of the obstacle surrounding the outdoor unit to 800mm or less from the bottom end of the outdoor unit.
 3. Draw out the pipe procured locally to the front of the outdoor unit horizontally, and keep 500mm or more between the outdoor unit and traversing pipe if placing pipe transversely.
 4. Arrange each outdoor unit in order of its capacity.
 5. Dimensional drawing of corrosion heavy protection model is the same as that of standard model.

Combination

Model	Outdoor unit	
	(1) Header unit	(2) Follower unit
MMY-AP2616HT8P	MMY-MAP1406HT8P	MMY-MAP1206HT8P
MMY-AP2816HT8P	MMY-MAP1606HT8P	MMY-MAP1206HT8P

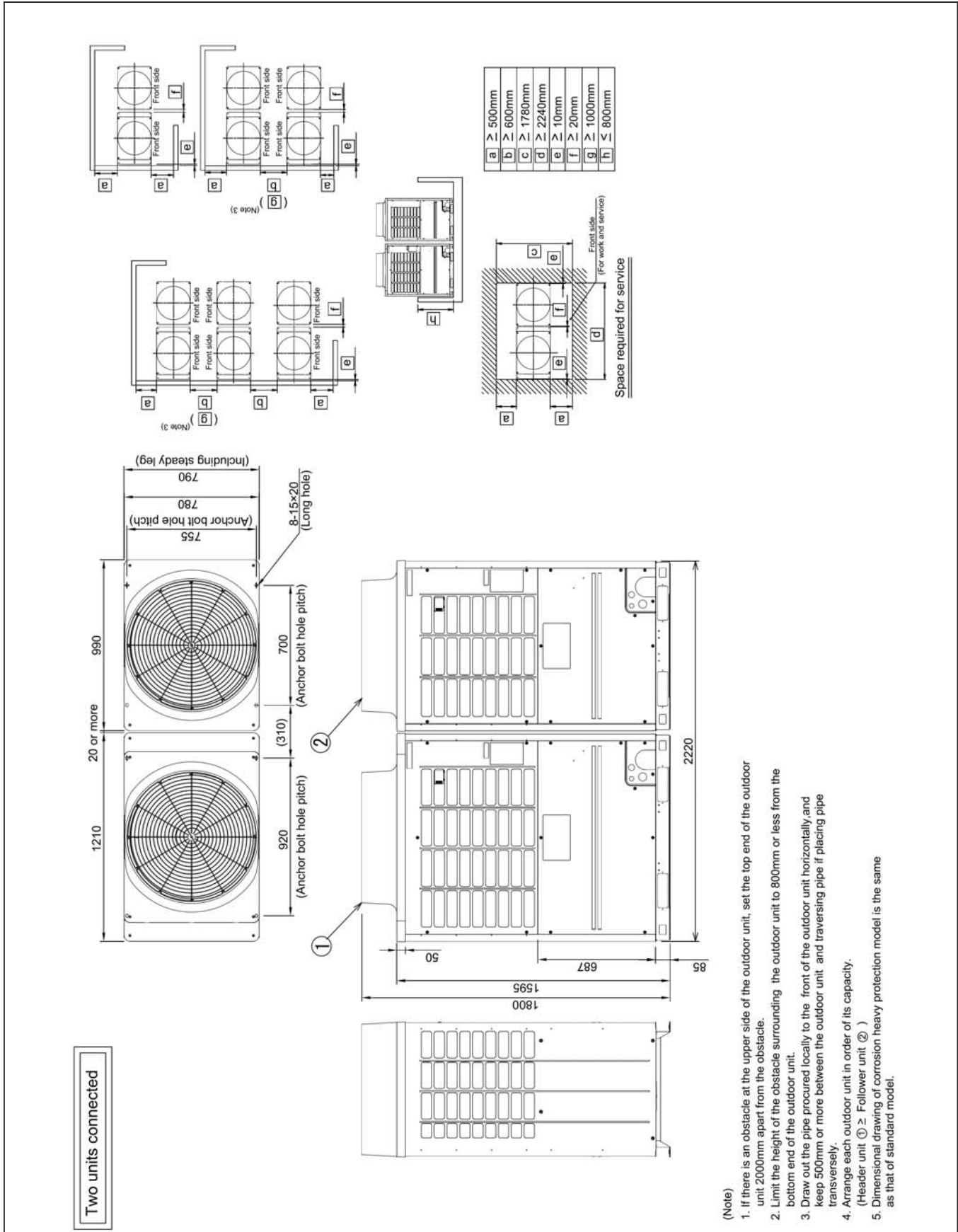

Combination

Model	Outdoor unit	
	(1) Header unit	(2) Follower unit
MMY-AP3016HT8P	MMY-MAP1606HT8P	MMY-MAP1406HT8P
MMY-AP3216HT8P	MMY-MAP1606HT8P	MMY-MAP1606HT8P

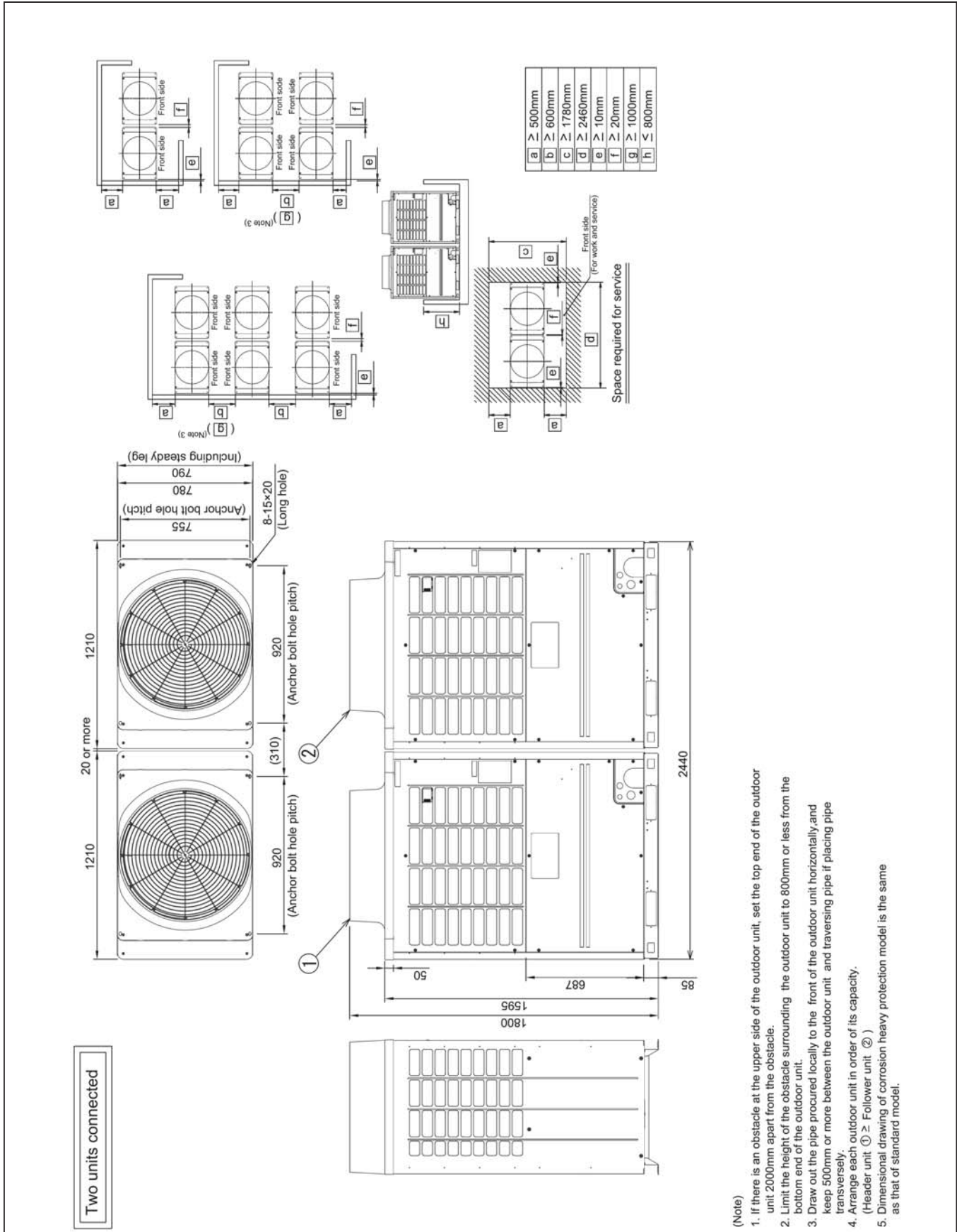

- (Note)
1. If there is an obstacle at the upper side of the outdoor unit, set the top end of the outdoor unit 2000mm apart from the obstacle.
 2. Limit the height of the obstacle surrounding the outdoor unit to 800mm or less from the bottom end of the outdoor unit.
 3. Draw out the pipe procured locally to the front of the outdoor unit horizontally and keep 500mm or more between the outdoor unit and traversing pipe if placing pipe transversely.
 4. Arrange each outdoor unit in order of its capacity.
 5. (Header unit ① ≥ Follower unit ②)
Dimensional drawing of corrosion heavy protection model is the same as that of standard model.



Combination

Model	Outdoor unit	
	(1) Header unit	(2) Follower unit
MMY-AP3416HT8P	MMY-MAP1806HT8P	MMY-MAP1606HT8P
MMY-AP3616HT8P	MMY-MAP2006HT8P	MMY-MAP1606HT8P
MMY-AP3816HT8P	MMY-MAP2206HT8P	MMY-MAP1606HT8P

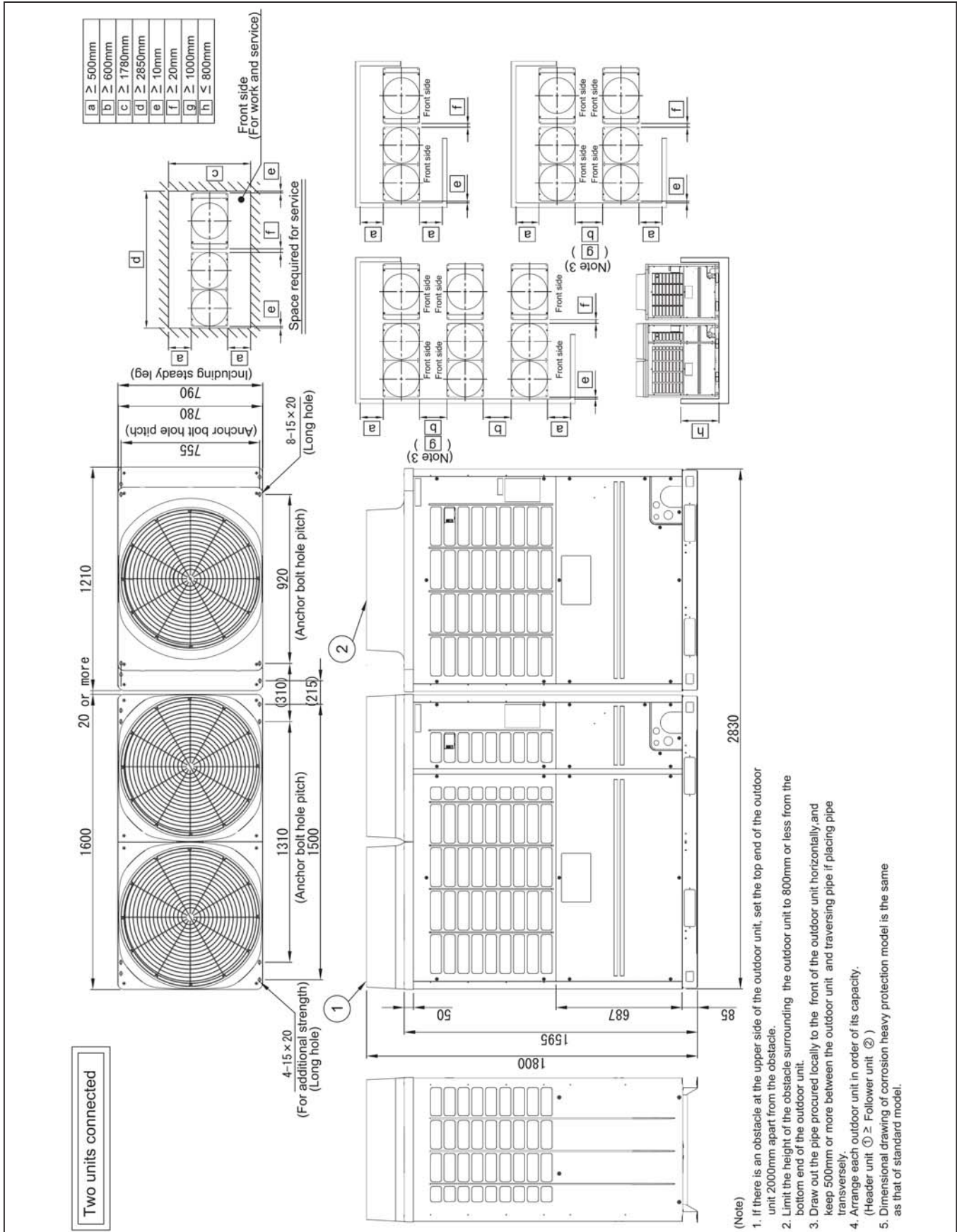

- (Note)
1. If there is an obstacle at the upper side of the outdoor unit, set the top end of the outdoor unit 2000mm apart from the obstacle.
 2. Limit the height of the obstacle surrounding the outdoor unit to 800mm or less from the bottom end of the outdoor unit.
 3. Draw out the pipe procured locally to the front of the outdoor unit horizontally and keep 500mm or more between the outdoor unit and traversing pipe if placing pipe transversely.
 4. Arrange each outdoor unit in order of its capacity.
(Header unit ① ≥ Follower unit ②)
 5. Dimensional drawing of corrosion heavy protection model is the same as that of standard model.



Combination

Model	Outdoor unit	
	(1) Header unit	(2) Follower unit
MMY-AP4016HT8P	MMY-MAP2006HT8P	MMY-MAP2006HT8P
MMY-AP4216HT8P	MMY-MAP2206HT8P	MMY-MAP2006HT8P
MMY-AP4416HT8P	MMY-MAP2206HT8P	MMY-MAP2206HT8P

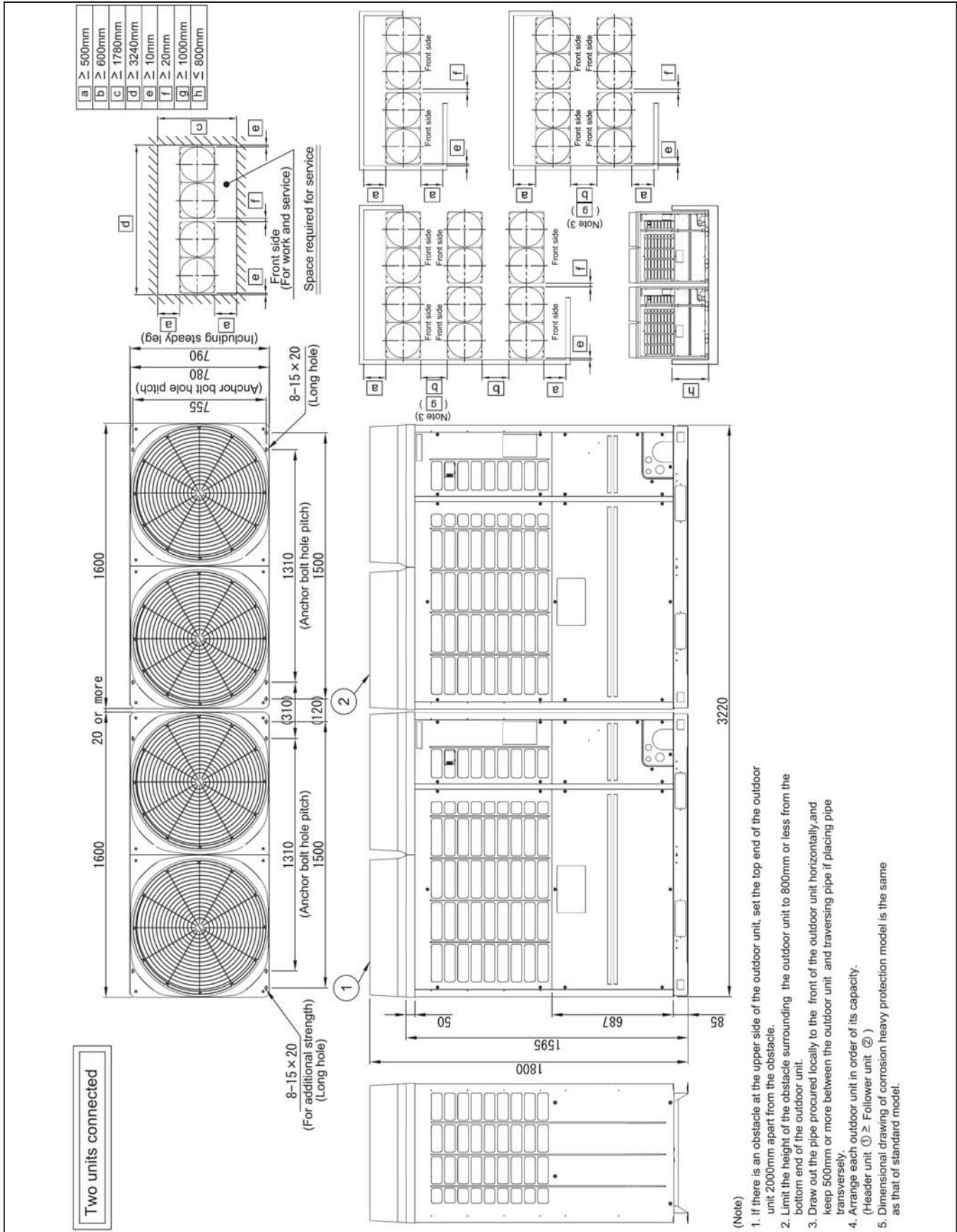

Combination

Model	Outdoor unit		
	(1) Header unit	(2) Follower unit	(3) Follower unit
MMY-AP3626HT8P	MMY-MAP1206HT8P	MMY-MAP1206HT8P	MMY-MAP1206HT8P

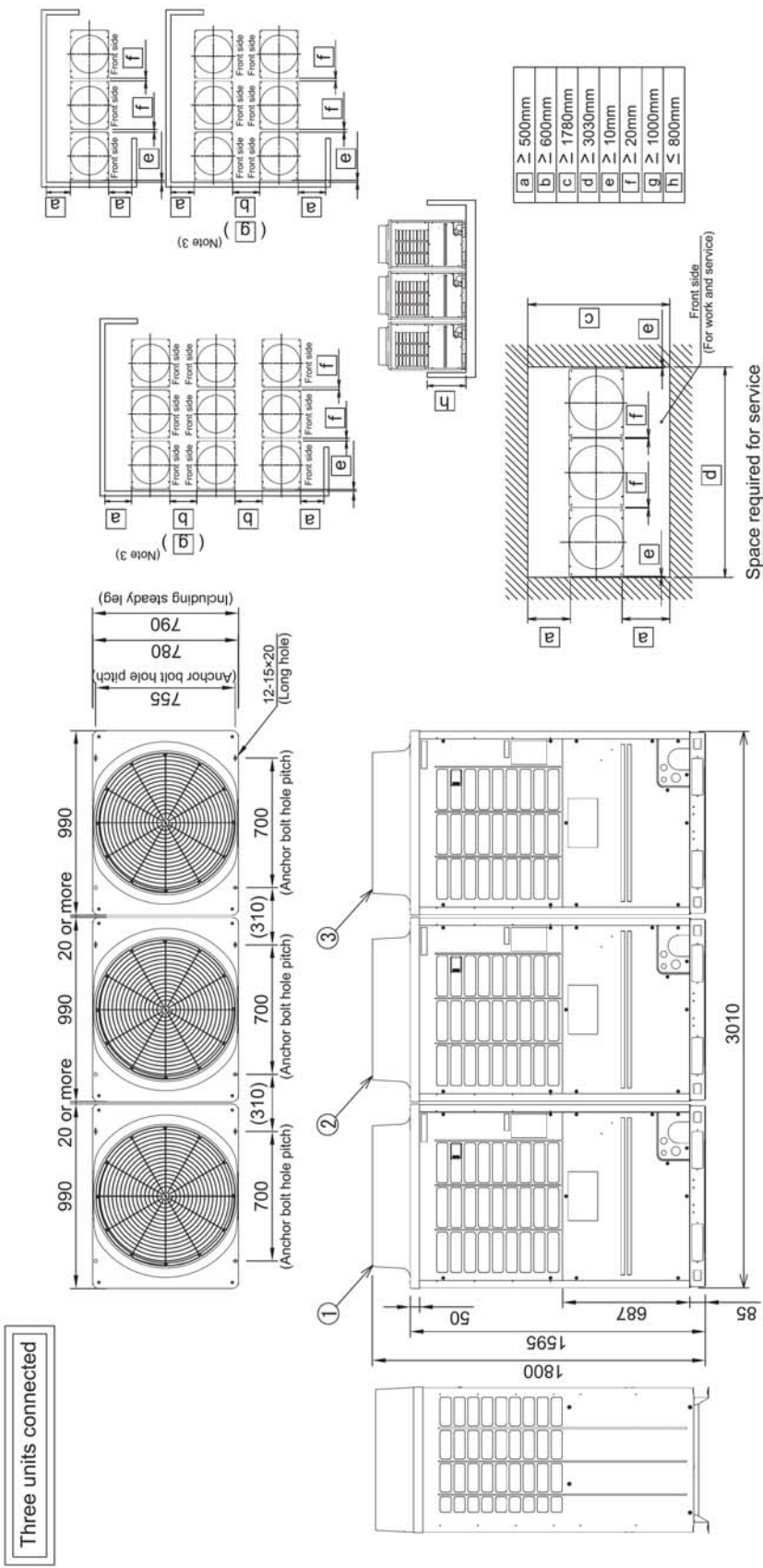

- (Note)
1. If there is an obstacle at the upper side of the outdoor unit, set the top end of the outdoor unit 2000mm apart from the obstacle.
 2. Limit the height of the obstacle surrounding the outdoor unit to 800mm or less from the bottom end of the outdoor unit.
 3. Draw out the pipe procured locally to the front of the outdoor unit horizontally, and keep 500mm or more between the outdoor unit and traversing pipe if placing pipe transversely.
 4. Arrange each outdoor unit in order of its capacity.
(Header unit ① ≥ Follower unit ② ≥ Follower unit ③)
 5. Dimensional drawing of corrosion heavy protection model is the same as that of standard model.

Combination

Model	Outdoor unit		
	(1) Header unit	(2) Follower unit	(3) Follower unit
MMY-AP3826HT8P	MMY-MAP1406HT8P	MMY-MAP1206HT8P	MMY-MAP1206HT8P

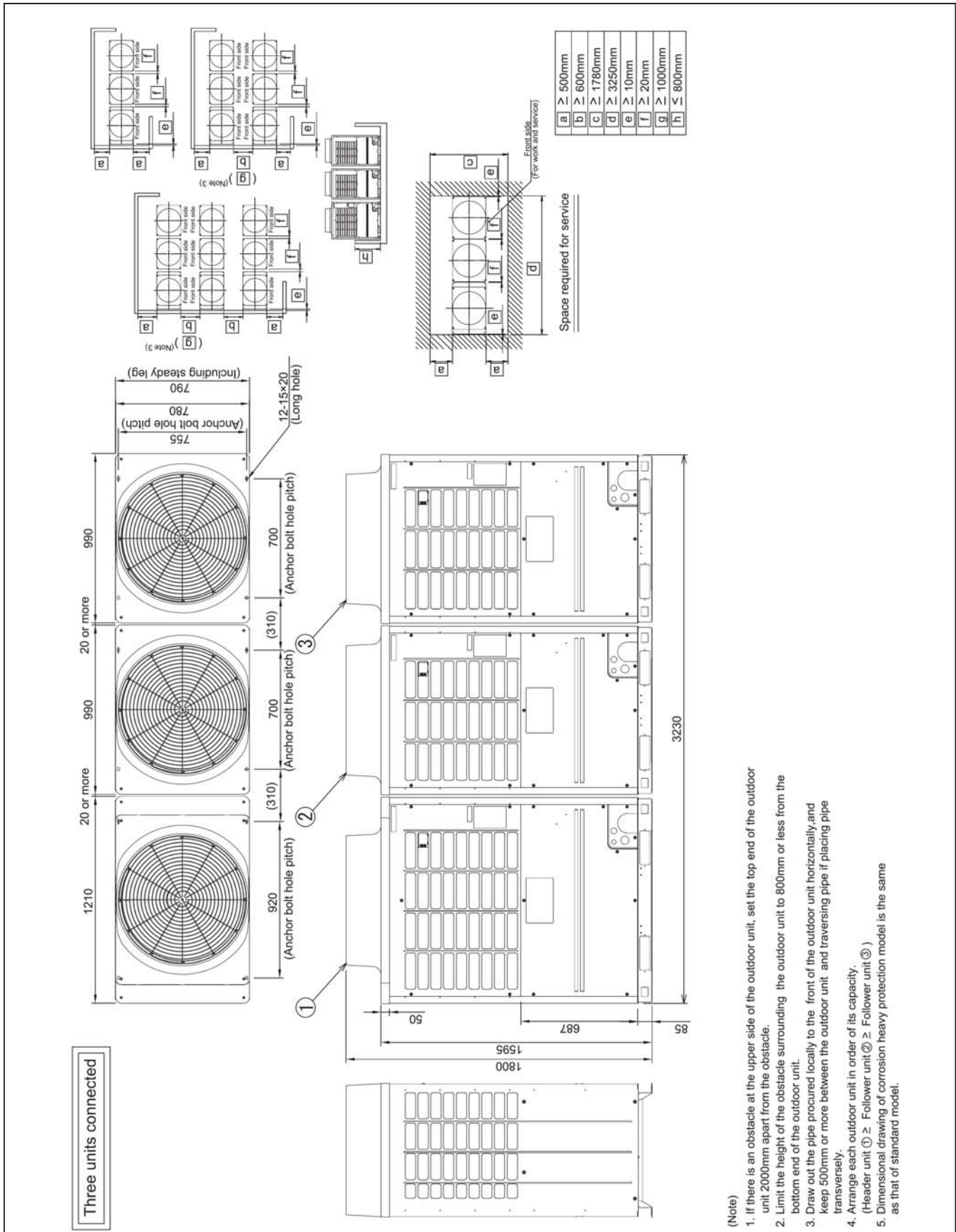

- (Note)
1. If there is an obstacle at the upper side of the outdoor unit, set the top end of the outdoor unit 2000mm apart from the obstacle.
 2. Limit the height of the obstacle surrounding the outdoor unit to 800mm or less from the bottom end of the outdoor unit.
 3. Draw out the pipe procured locally to the front of the outdoor unit horizontally, and keep 500mm or more between the outdoor unit and traversing pipe if placing pipe transversely.
 4. Arrange each outdoor unit in order of its capacity.
(Header unit ① ≥ Follower unit ② ≥ Follower unit ③)
 5. Dimensional drawing of corrosion heavy protection model is the same as that of standard model.

Combination

Model	Outdoor unit		
	(1) Header unit	(2) Follower unit	(3) Follower unit
MMY-AP4026HT8P	MMY-MAP1406HT8P	MMY-MAP1406HT8P	MMY-MAP1206HT8P

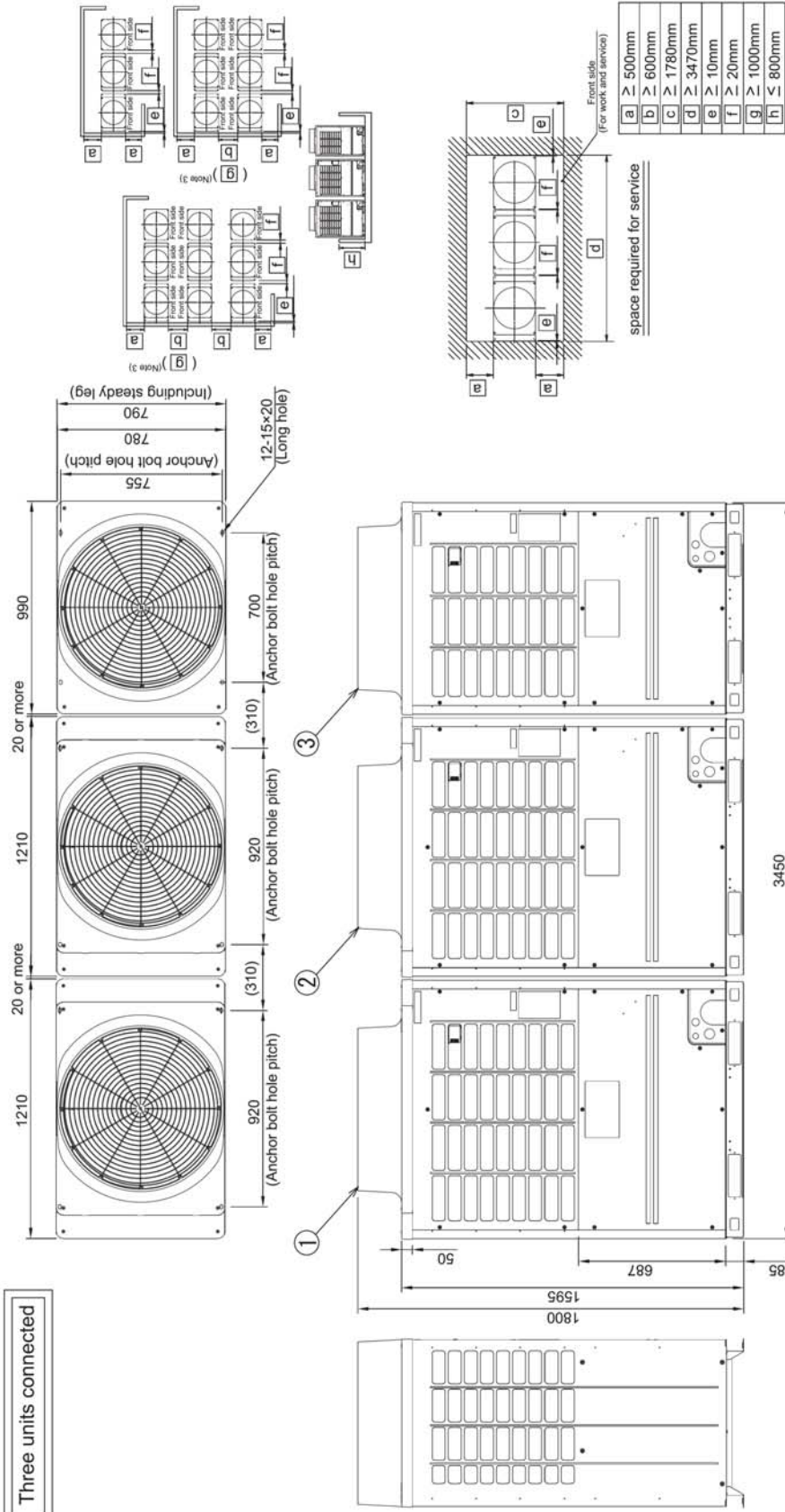

- (Note)
1. If there is an obstacle at the upper side of the outdoor unit, set the top end of the outdoor unit 2000mm apart from the obstacle.
 2. Limit the height of the obstacle surrounding the outdoor unit to 800mm or less from the bottom end of the outdoor unit.
 3. Draw out the pipe procured locally to the front of the outdoor unit horizontally, and keep 500mm or more between the outdoor unit and traversing pipe if placing pipe transversely.
 4. Arrange each outdoor unit in order of its capacity.
(Header unit ① ≥ Follower unit ② ≥ Follower unit ③)
 5. Dimensional drawing of corrosion heavy protection model is the same as that of standard model.



Combination

Model	Outdoor unit		
	(1) Header unit	(2) Follower unit	(3) Follower unit
MMY-AP4226HT8P	MMY-MAP1406HT8P	MMY-MAP1406HT8P	MMY-MAP1406HT8P
MMY-AP4426HT8P	MMY-MAP1606HT8P	MMY-MAP1406HT8P	MMY-MAP1406HT8P
MMY-AP4616HT8P	MMY-MAP1606HT8P	MMY-MAP1606HT8P	MMY-MAP1406HT8P
MMY-AP4816HT8P	MMY-MAP1606HT8P	MMY-MAP1606HT8P	MMY-MAP1606HT8P

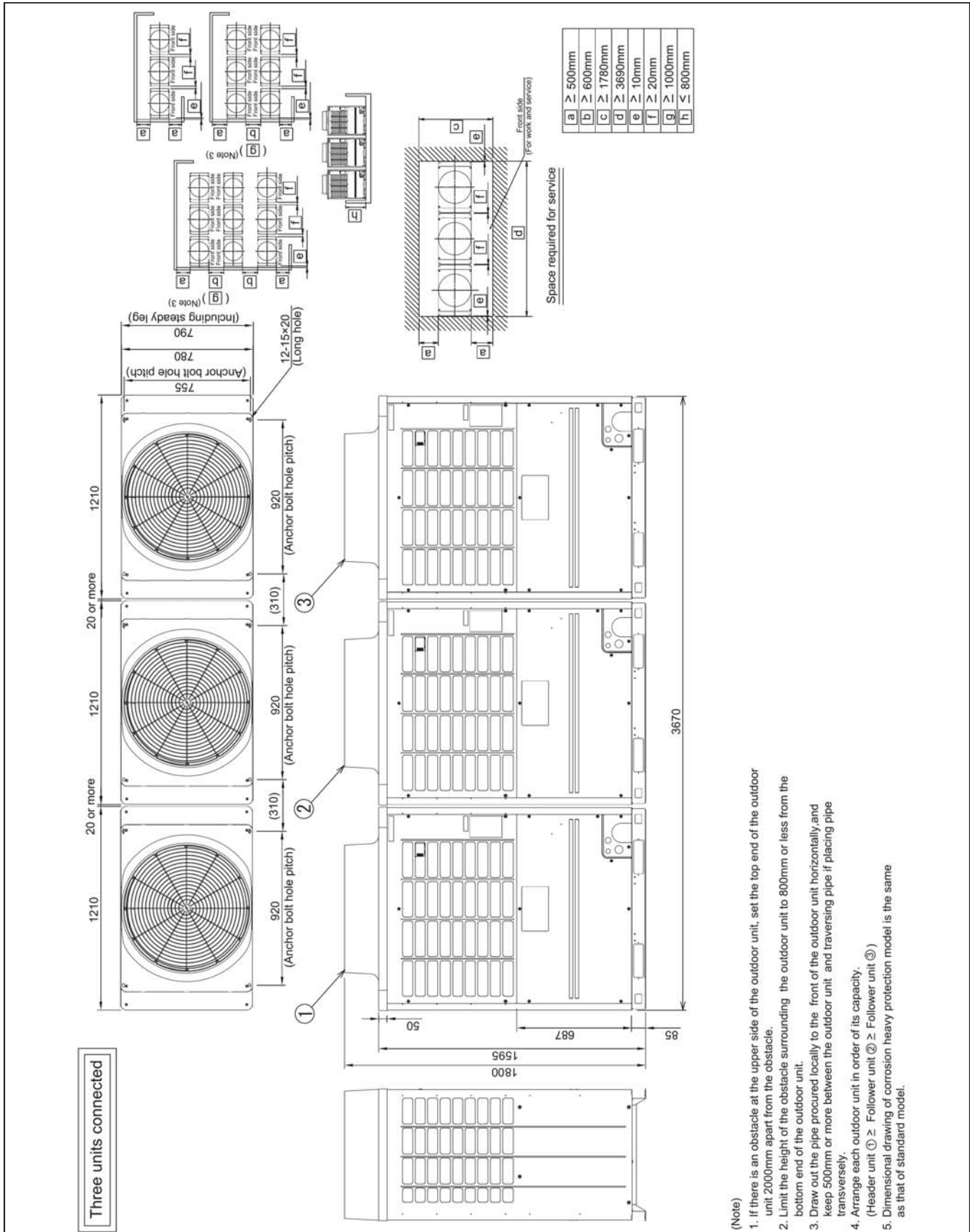

- (Note)
1. If there is an obstacle at the upper side of the outdoor unit, set the top end of the outdoor unit 2000mm apart from the obstacle.
 2. Limit the height of the obstacle surrounding the outdoor unit to 800mm or less from the bottom end of the outdoor unit.
 3. Draw out the pipe procured locally to the front of the outdoor unit horizontally, and keep 500mm or more between the outdoor unit and traversing pipe if placing pipe transversely.
 4. Arrange each outdoor unit in order of its capacity.
 5. (Header unit ① ≥ Follower unit ② ≥ Follower unit ③)
Dimensional drawing of corrosion heavy protection model is the same as that of standard model.



Combination

Model	Outdoor unit		
	(1) Header unit	(2) Follower unit	(3) Follower unit
MMY-AP5016HT8P	MMY-MAP1806HT8P	MMY-MAP1606HT8P	MMY-MAP1606HT8P
MMY-AP5216HT8P	MMY-MAP2006HT8P	MMY-MAP1606HT8P	MMY-MAP1606HT8P
MMY-AP5416HT8P	MMY-MAP2206HT8P	MMY-MAP1606HT8P	MMY-MAP1606HT8P

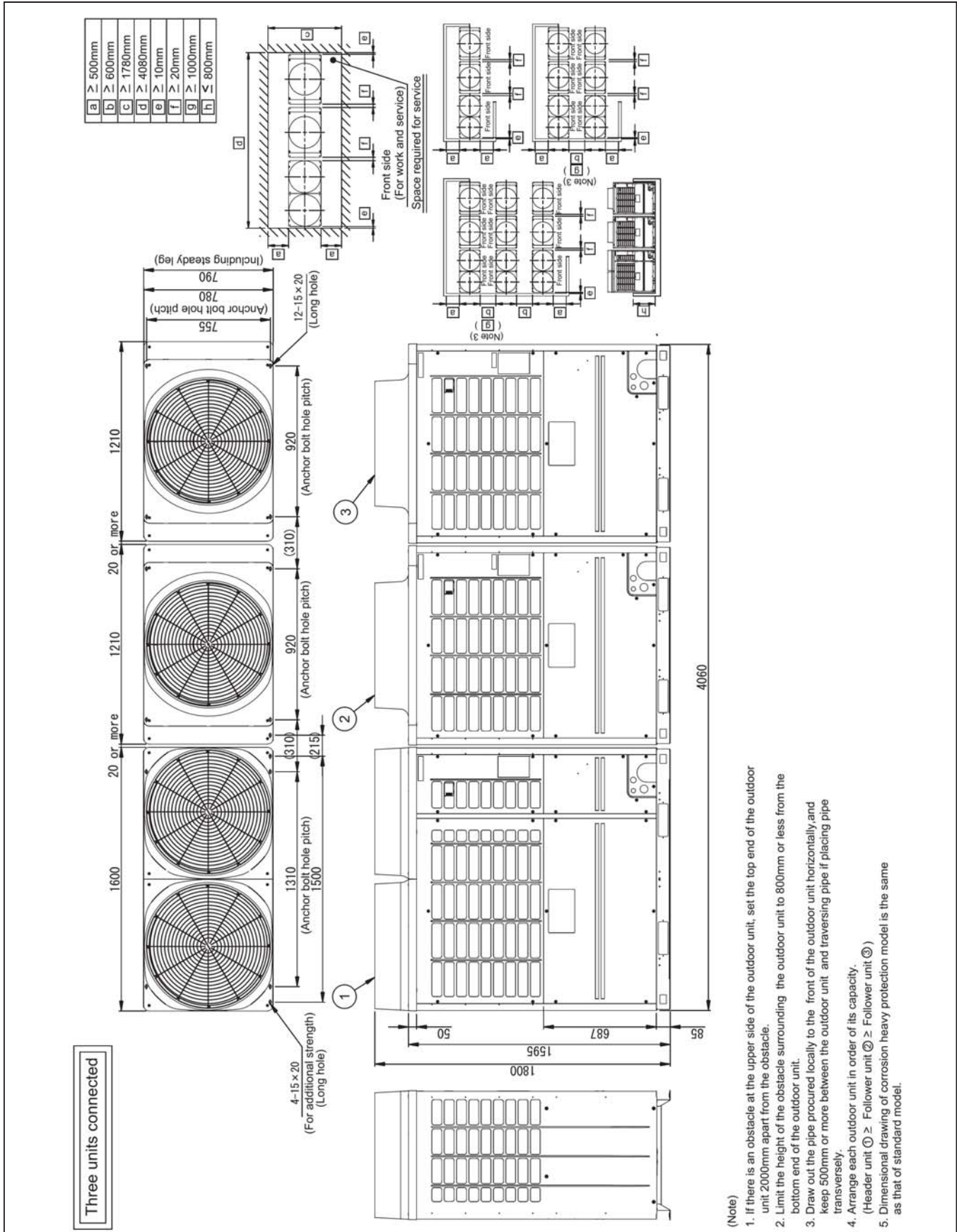

Combination

Model	Outdoor unit		
	(1) Header unit	(2) Follower unit	(3) Follower unit
MMY-AP5426HT8P	MMY-MAP2006HT8P	MMY-MAP2006HT8P	MMY-MAP1406HT8P
MMY-AP5616HT8P	MMY-MAP2006HT8P	MMY-MAP2006HT8P	MMY-MAP1606HT8P
MMY-AP5816HT8P	MMY-MAP2206HT8P	MMY-MAP2006HT8P	MMY-MAP1606HT8P
MMY-AP6016HT8P	MMY-MAP2206HT8P	MMY-MAP2206HT8P	MMY-MAP1606HT8P

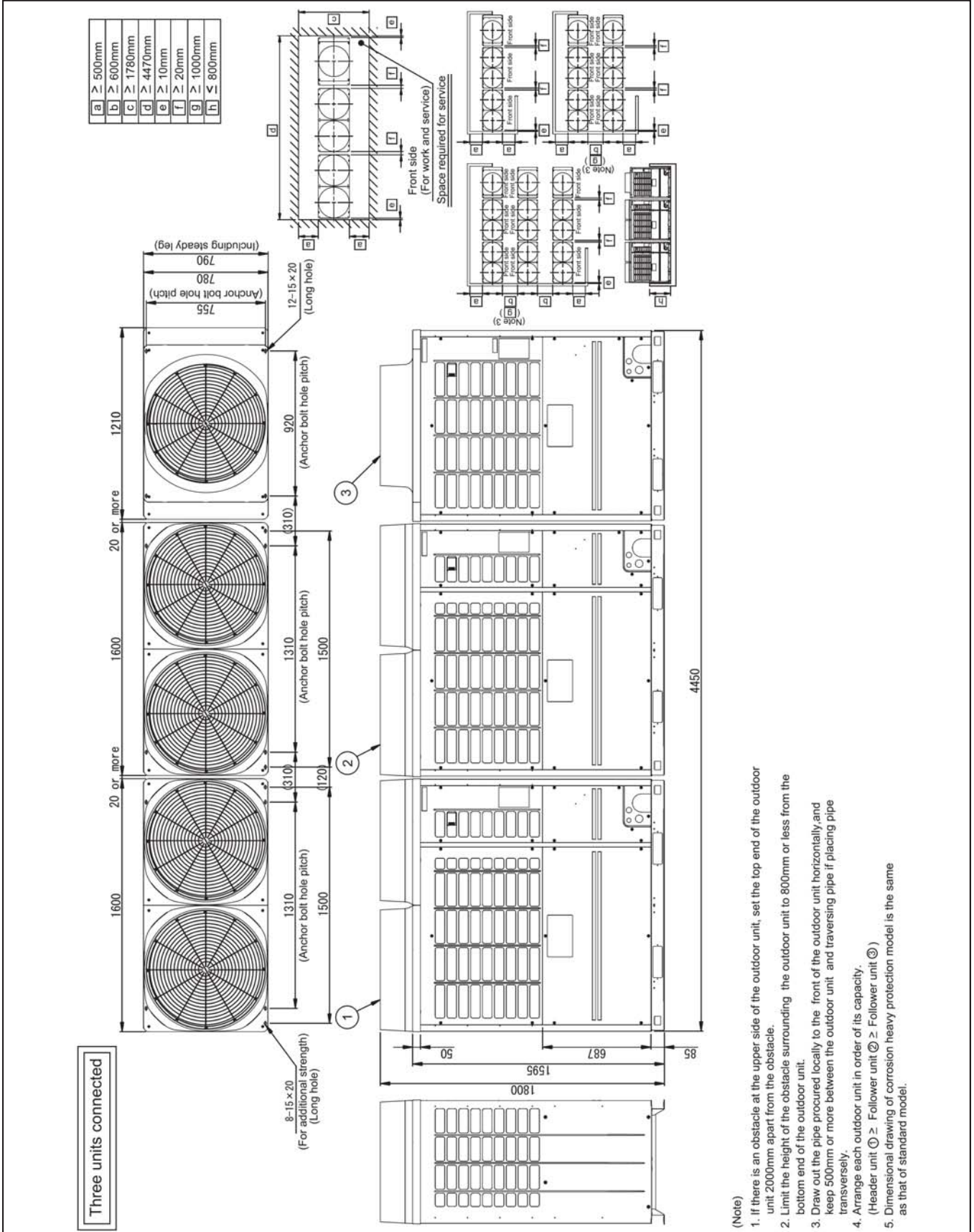

- (Note)
1. If there is an obstacle at the upper side of the outdoor unit, set the top end of the outdoor unit 2000mm apart from the obstacle.
 2. Limit the height of the obstacle surrounding the outdoor unit to 800mm or less from the bottom end of the outdoor unit.
 3. Draw out the pipe procured locally to the front of the outdoor unit horizontally, and keep 500mm or more between the outdoor unit and traversing pipe if placing pipe transversely.
 4. Arrange each outdoor unit in order of its capacity.
 5. Dimensional drawing of corrosion heavy protection model is the same as that of standard model.



Single unit

Model : MMY-MAP0806HT7P, MAP1006HT7P, MAP1206HT7P

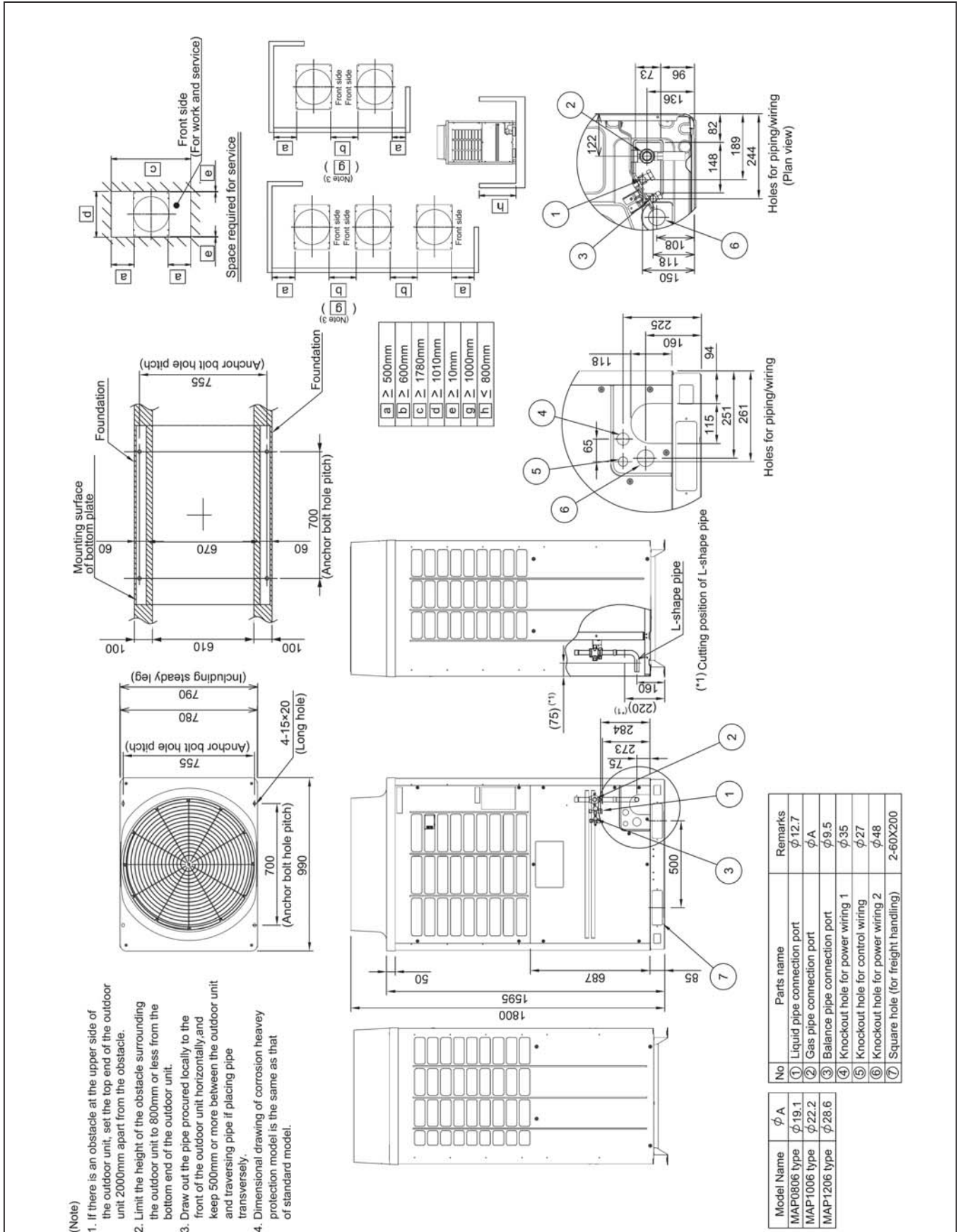

Single unit

Model : MMY-MAP1406HT7P, MAP1606HT7P

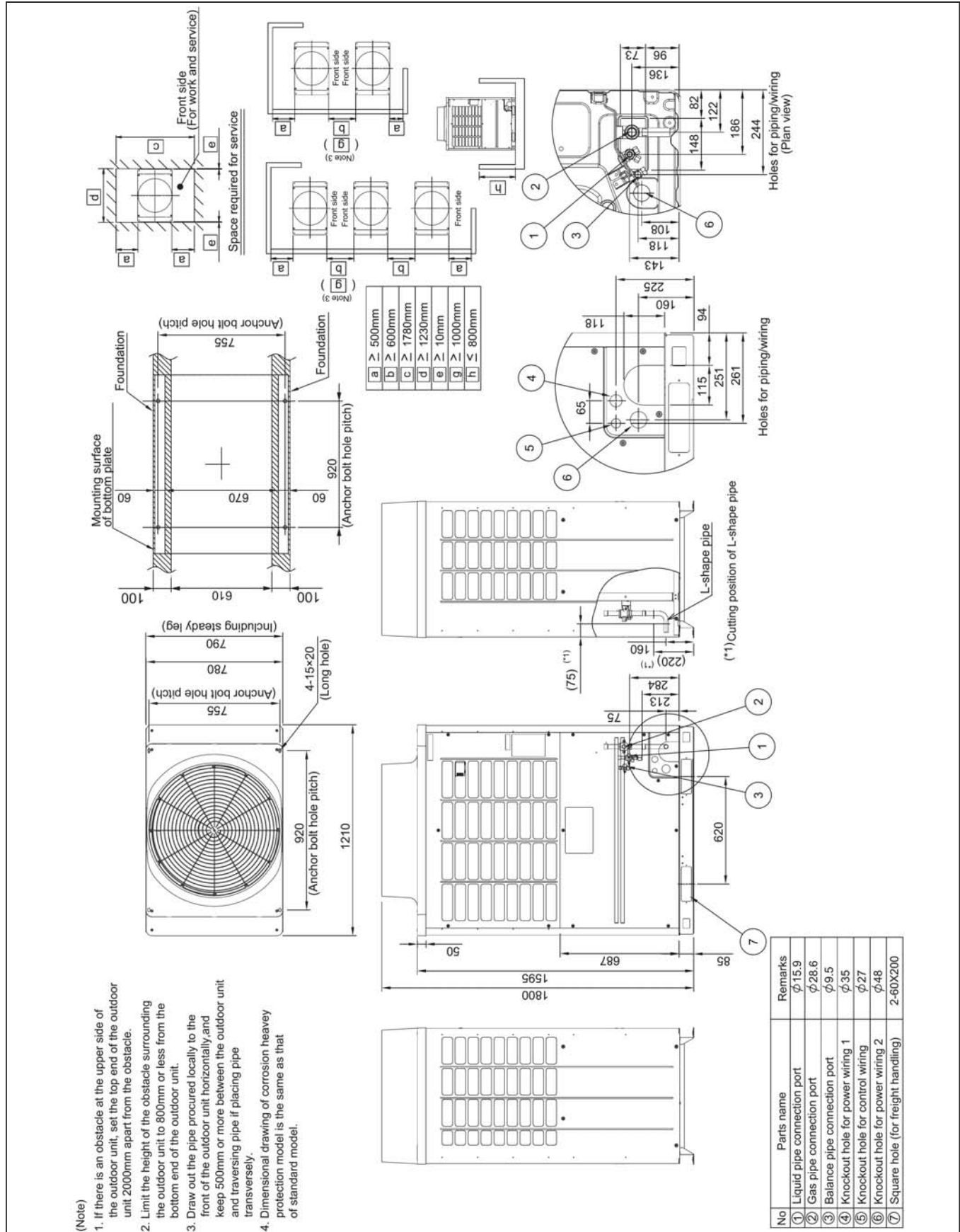

Single unit

Model : MMY-MAP1806HT7P, MAP2006HT7P, MAP2206HT7P

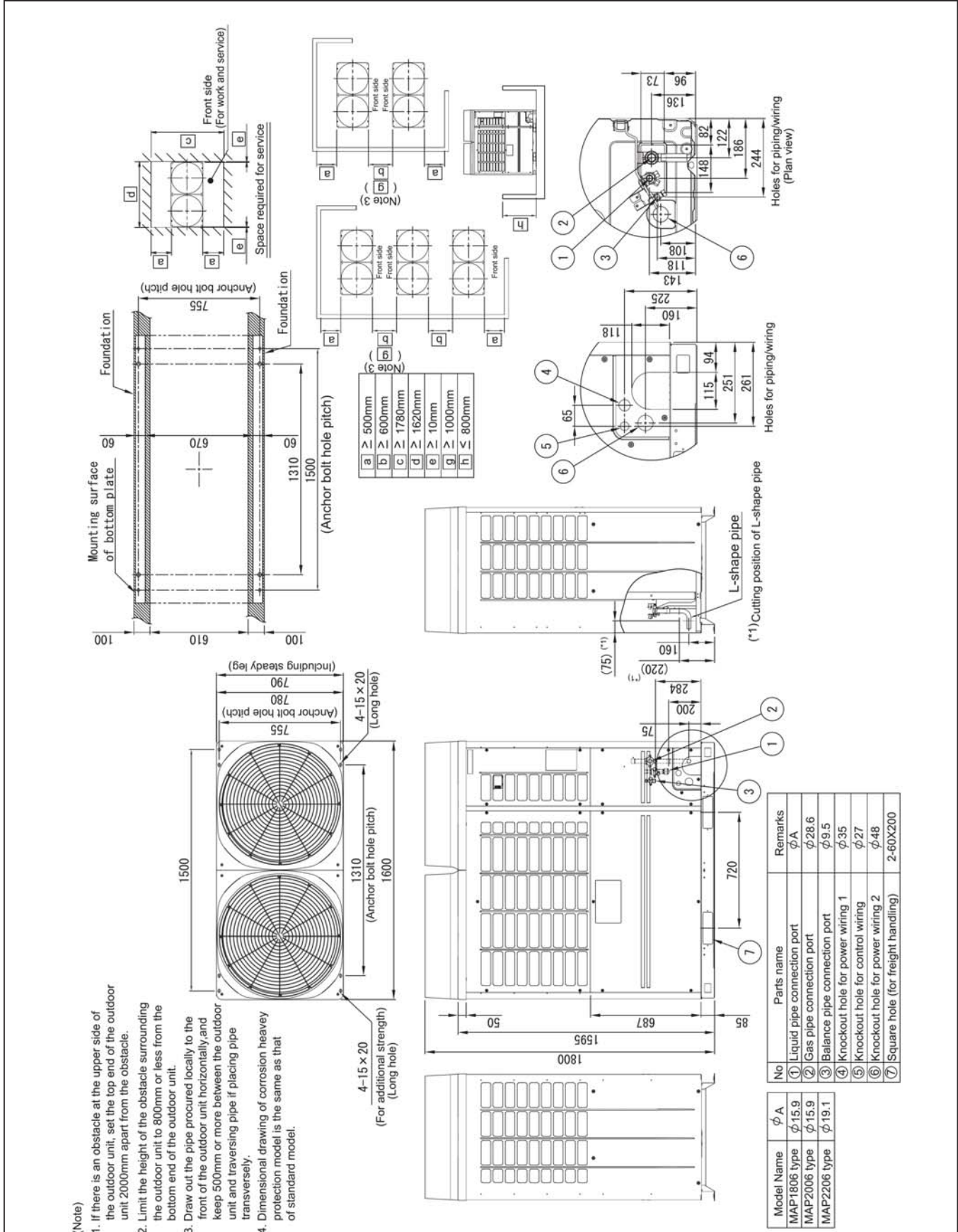

Combination

Model	Outdoor unit	
	(1) Header unit	(2) Follower unit
MMY-AP2026HT7P	MMY-MAP1006HT7P	MMY-MAP1006HT7P
MMY-AP2226HT7P	MMY-MAP1206HT7P	MMY-MAP1006HT7P
MMY-AP2416HT7P	MMY-MAP1206HT7P	MMY-MAP1206HT7P

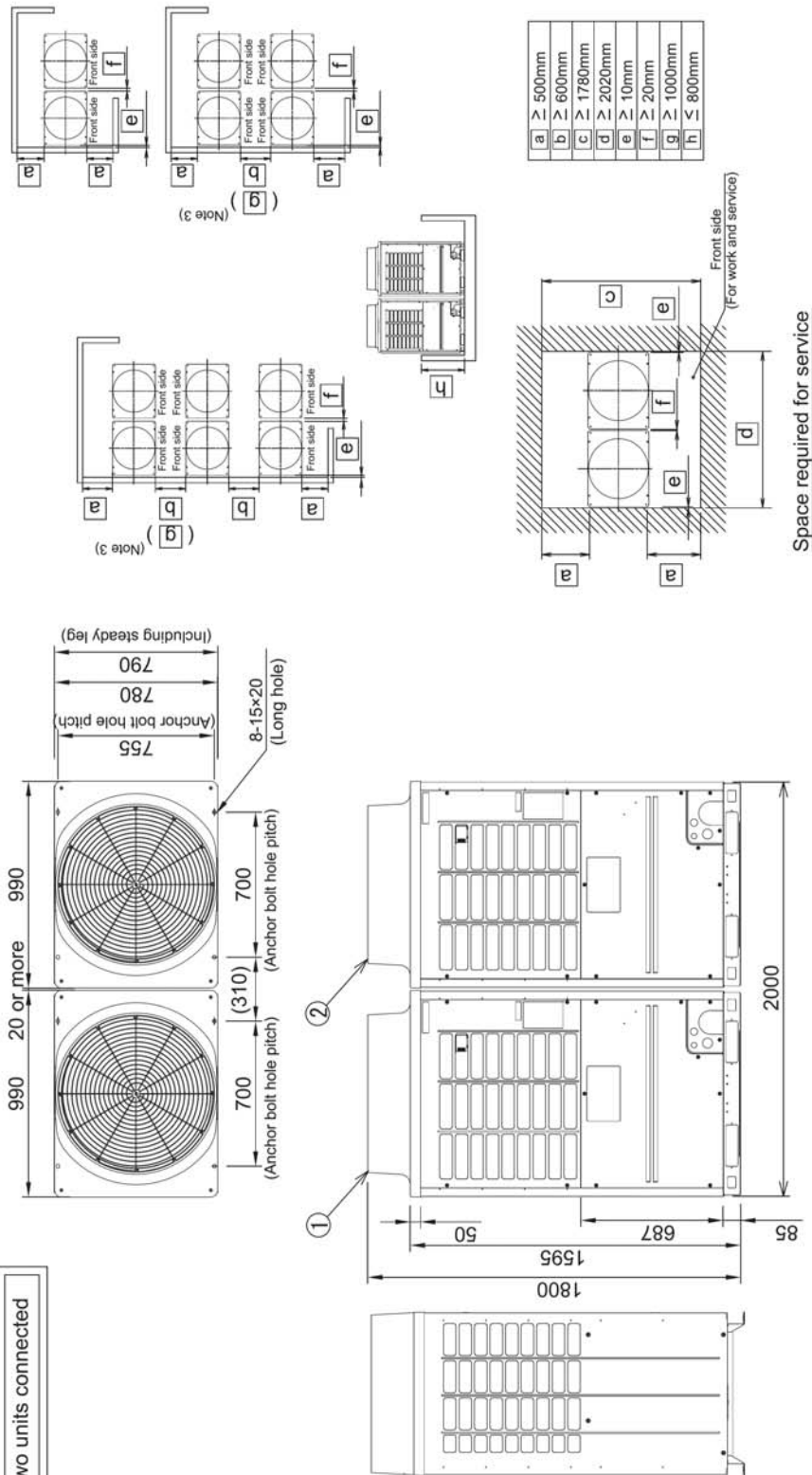

- (Note)
1. If there is an obstacle at the upper side of the outdoor unit, set the top end of the outdoor unit 2000mm apart from the obstacle.
 2. Limit the height of the obstacle surrounding the outdoor unit to 800mm or less from the bottom end of the outdoor unit.
 3. Draw out the pipe procured locally to the front of the outdoor unit horizontally, and keep 500mm or more between the outdoor unit and traversing pipe if placing pipe transversely.
 4. Arrange each outdoor unit in order of its capacity.
 5. Dimensional drawing of corrosion heavy protection model is the same as that of standard model.

Combination

Model	Outdoor unit	
	(1) Header unit	(2) Follower unit
MMY-AP2616HT7P	MMY-MAP1406HT7P	MMY-MAP1206HT7P
MMY-AP2816HT7P	MMY-MAP1606HT7P	MMY-MAP1206HT7P

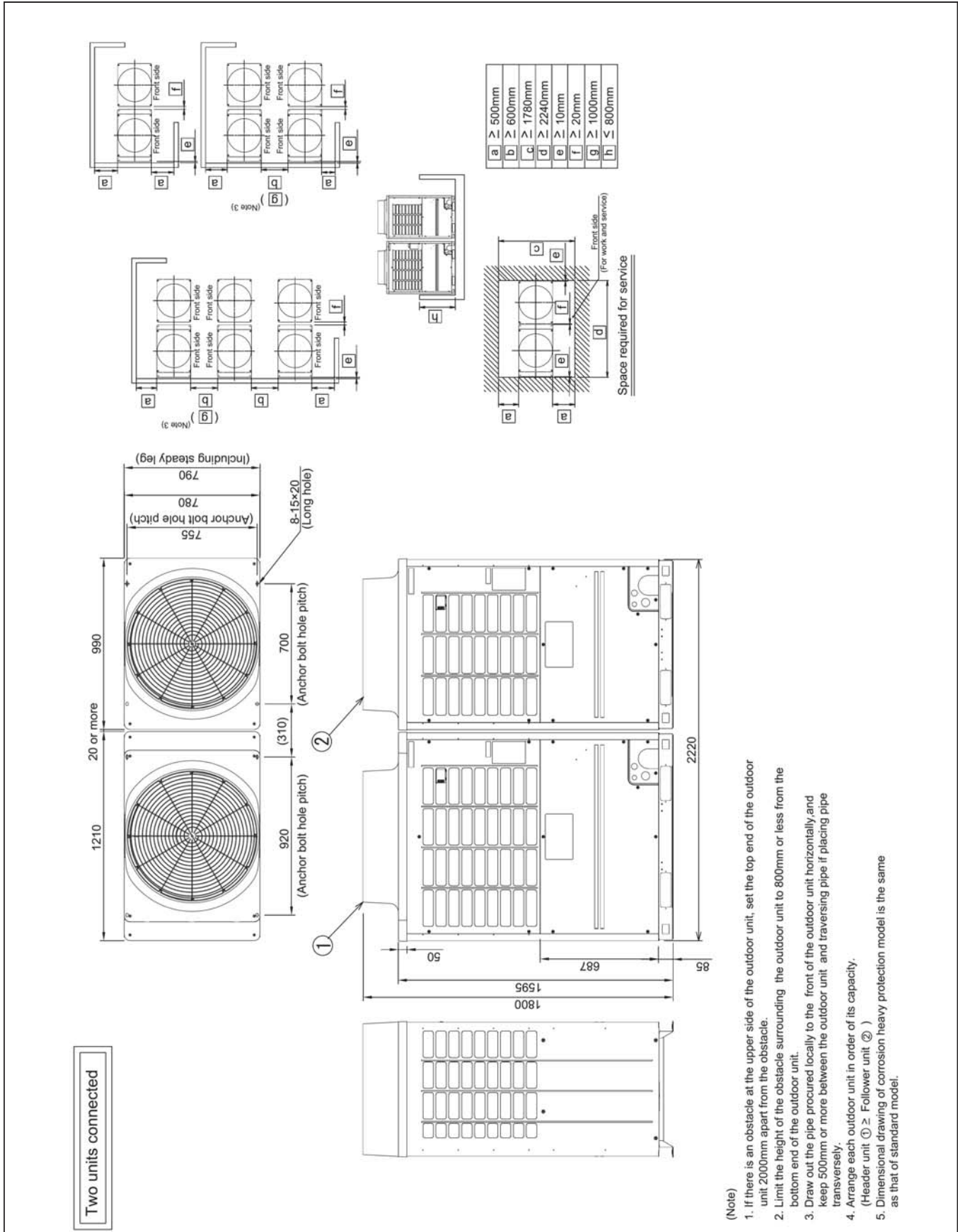

Combination

Model	Outdoor unit	
	(1) Header unit	(2) Follower unit
MMY-AP3016HT7P	MMY-MAP1606HT7P	MMY-MAP1406HT7P
MMY-AP3216HT7P	MMY-MAP1606HT7P	MMY-MAP1606HT7P

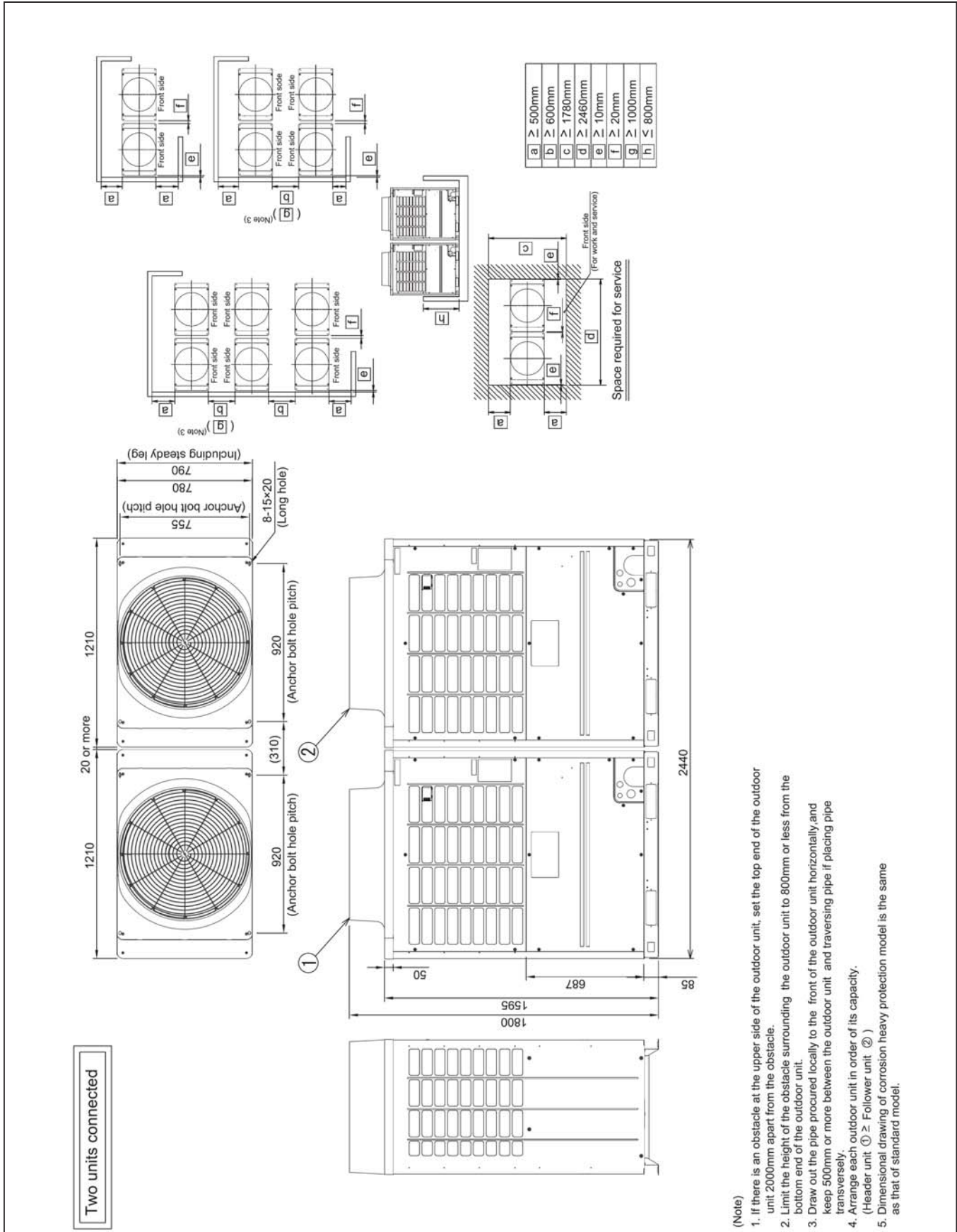

Combination

Model	Outdoor unit	
	(1) Header unit	(2) Follower unit
MMY-AP3416HT7P	MMY-MAP1806HT7P	MMY-MAP1606HT7P
MMY-AP3616HT7P	MMY-MAP2006HT7P	MMY-MAP1606HT7P
MMY-AP3816HT7P	MMY-MAP2206HT7P	MMY-MAP1606HT7P

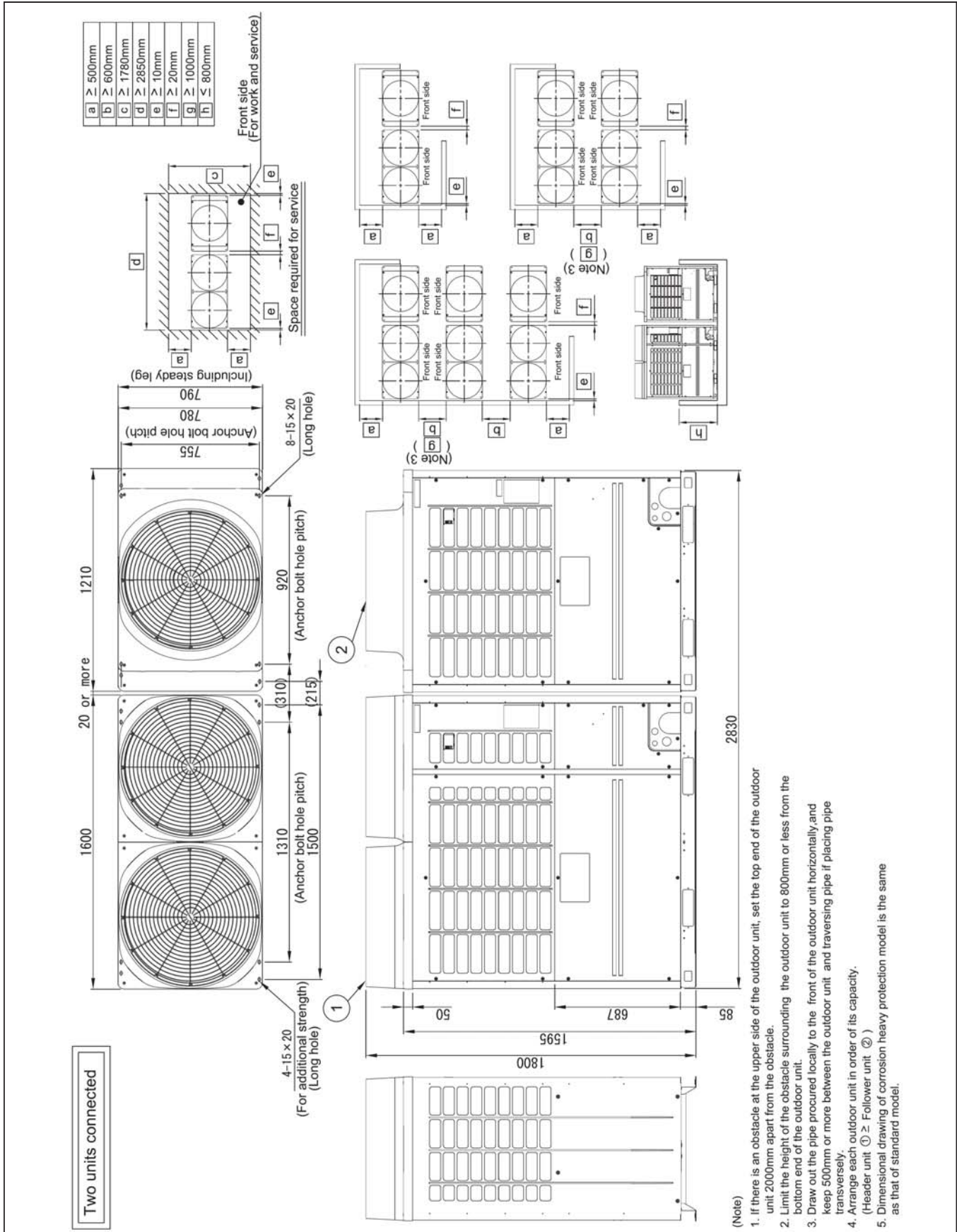



Combination

Model	Outdoor unit	
	(1) Header unit	(2) Follower unit
MMY-AP4016HT7P	MMY-MAP2006HT7P	MMY-MAP2006HT7P
MMY-AP4216HT7P	MMY-MAP2206HT7P	MMY-MAP2006HT7P
MMY-AP4416HT7P	MMY-MAP2206HT7P	MMY-MAP2206HT7P

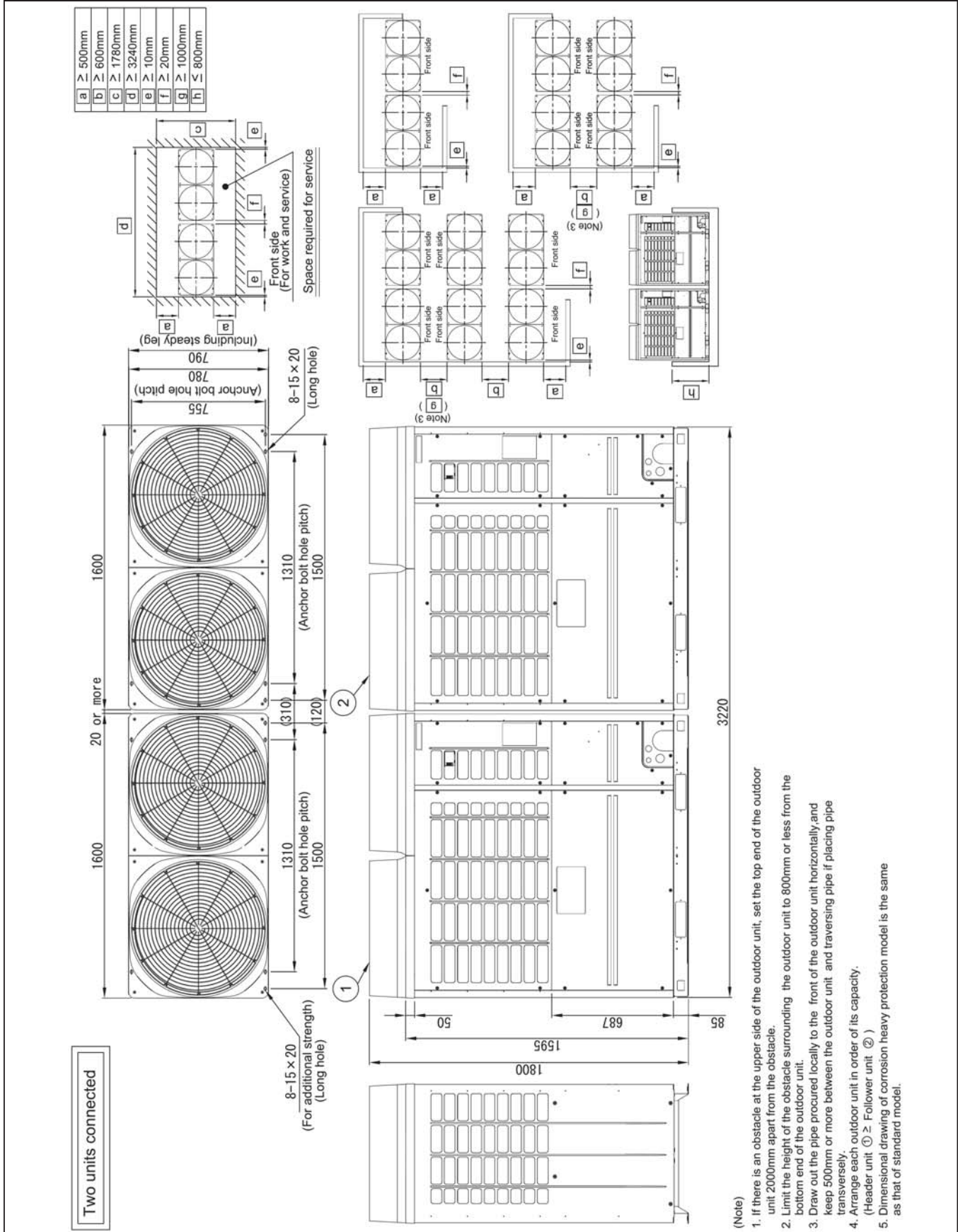

Combination

Model	Outdoor unit		
	(1) Header unit	(2) Follower unit	(3) Follower unit
MMY-AP3626HT7P	MMY-MAP1206HT7P	MMY-MAP1206HT7P	MMY-MAP1206HT7P

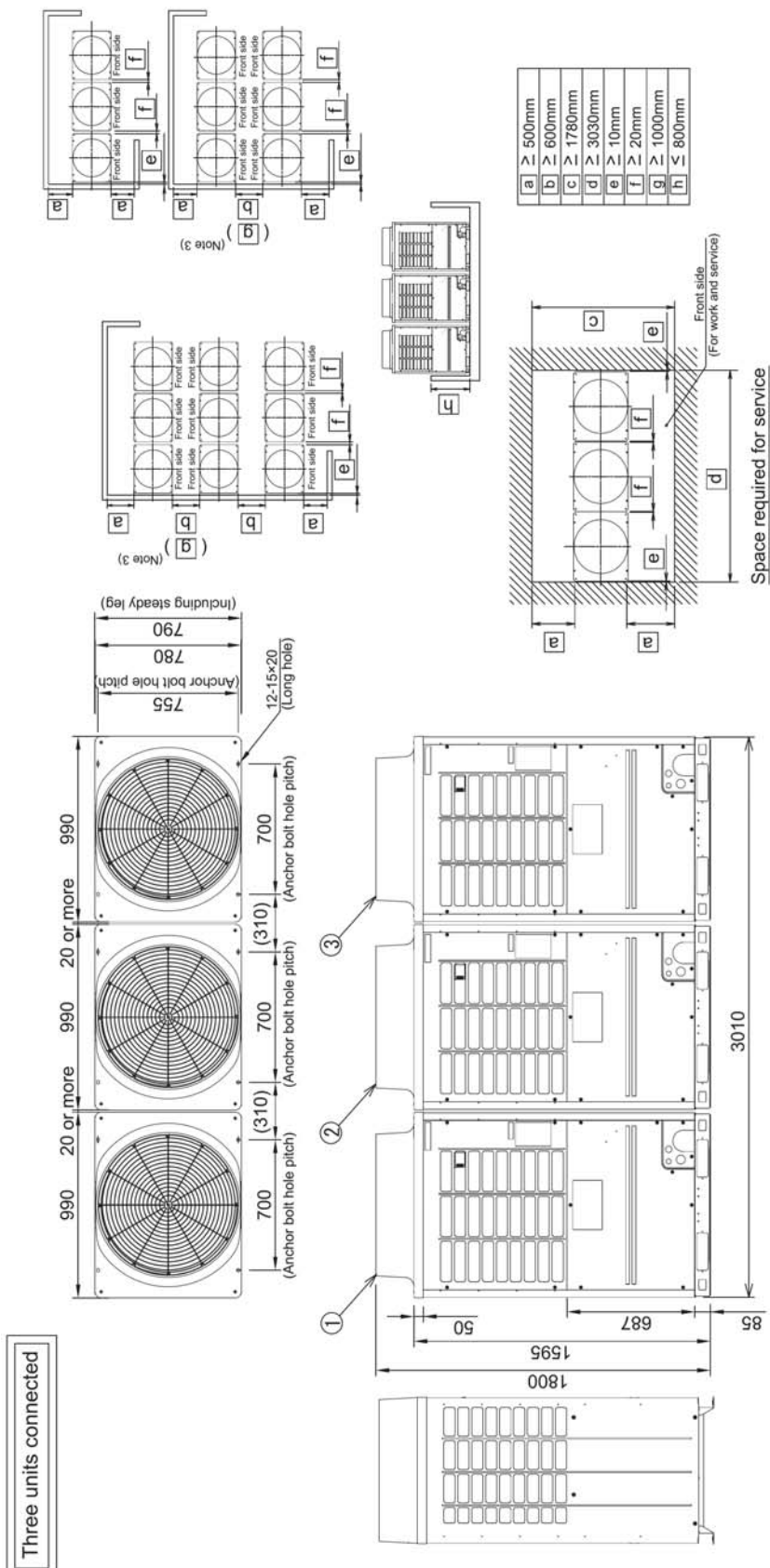

- (Note)
1. If there is an obstacle at the upper side of the outdoor unit, set the top end of the outdoor unit 2000mm apart from the obstacle.
 2. Limit the height of the obstacle surrounding the outdoor unit to 800mm or less from the bottom end of the outdoor unit.
 3. Draw out the pipe procured locally to the front of the outdoor unit horizontally, and keep 500mm or more between the outdoor unit and traversing pipe if placing pipe transversely.
 4. Arrange each outdoor unit in order of its capacity.
(-Header unit ① ≥ Follower unit ② ≥ Follower unit ③)
 5. Dimensional drawing of corrosion heavy protection model is the same as that of standard model.

Combination

Model	Outdoor unit		
	(1) Header unit	(2) Follower unit	(3) Follower unit
MMY-AP3826HT7P	MMY-MAP1406HT7P	MMY-MAP1206HT7P	MMY-MAP1206HT7P

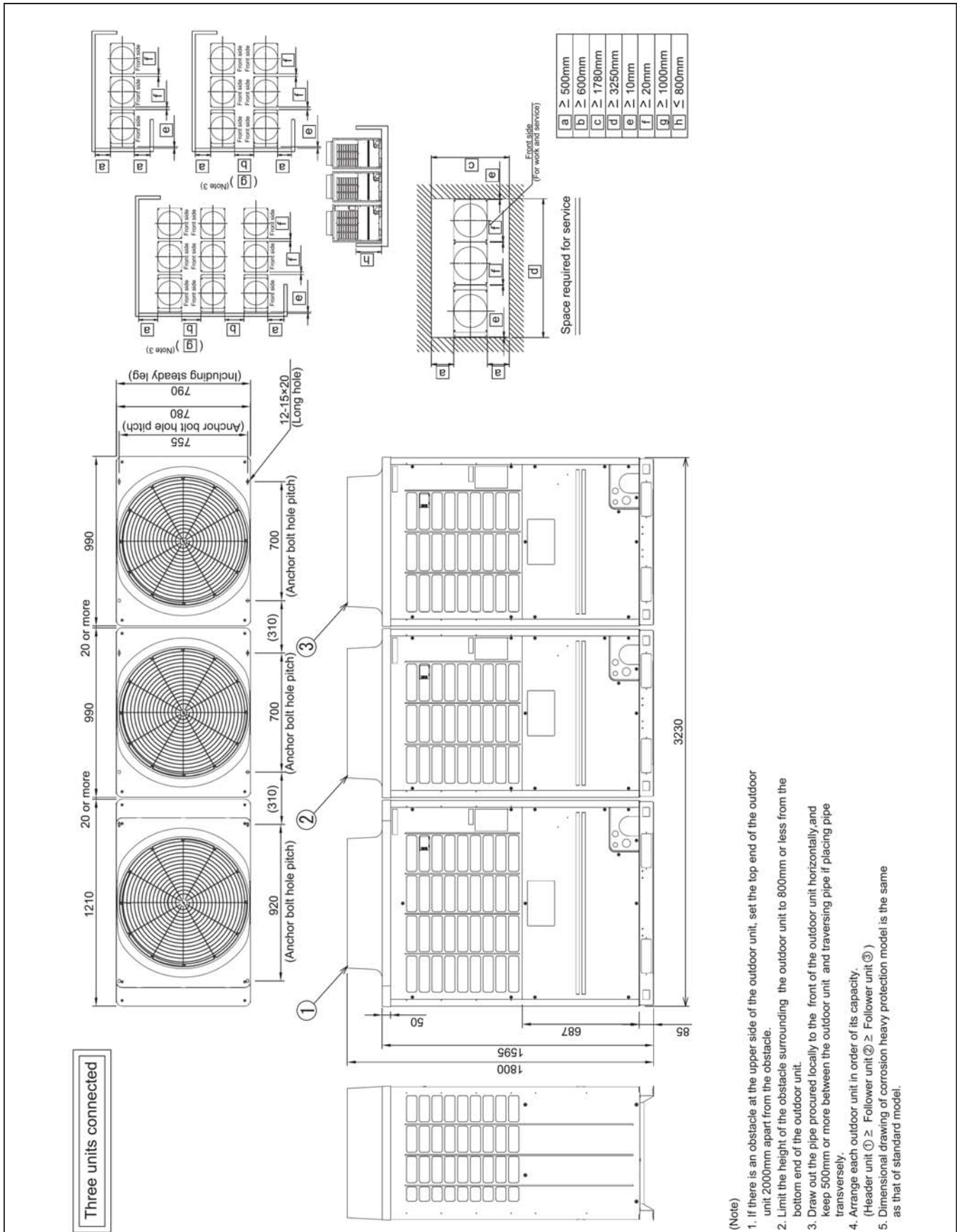

Combination

Model	Outdoor unit		
	(1) Header unit	(2) Follower unit	(3) Follower unit
MMY-AP4026HT7P	MMY-MAP1406HT7P	MMY-MAP1406HT7P	MMY-MAP1206HT7P

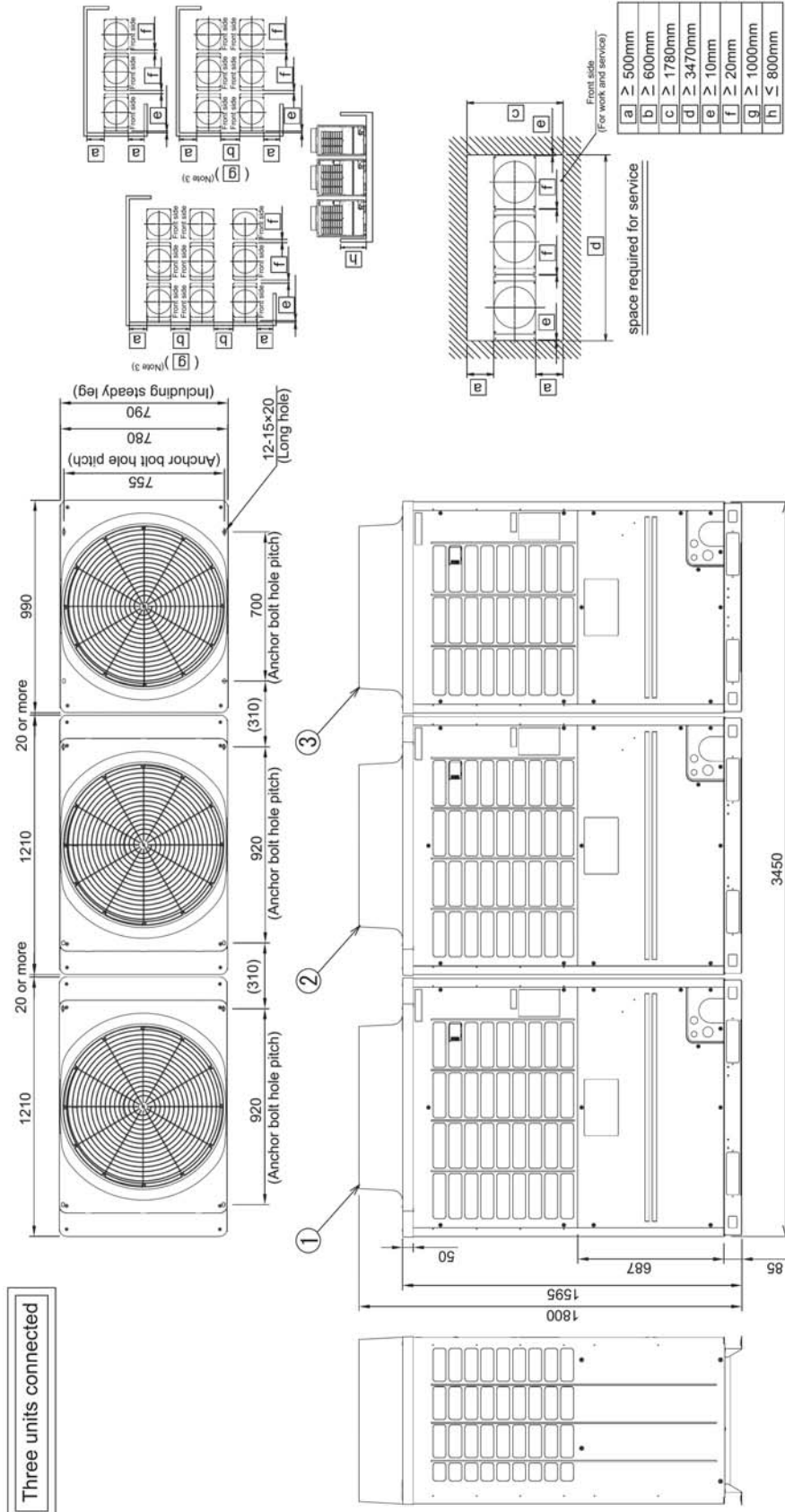

- (Note)
1. If there is an obstacle at the upper side of the outdoor unit, set the top end of the outdoor unit 2000mm apart from the obstacle.
 2. Limit the height of the obstacle surrounding the outdoor unit to 800mm or less from the bottom end of the outdoor unit.
 3. Draw out the pipe procured locally to the front of the outdoor unit horizontally, and keep 500mm or more between the outdoor unit and traversing pipe if placing pipe transversely.
 4. Arrange each outdoor unit in order of its capacity.
(Header unit ① ≥ Follower unit ② ≥ Follower unit ③)
 5. Dimensional drawing of corrosion heavy protection model is the same as that of standard model.

Combination

Model	Outdoor unit		
	(1) Header unit	(2) Follower unit	(3) Follower unit
MMY-AP4226HT7P	MMY-MAP1406HT7P	MMY-MAP1406HT7P	MMY-MAP1406HT7P
MMY-AP4426HT7P	MMY-MAP1606HT7P	MMY-MAP1406HT7P	MMY-MAP1406HT7P
MMY-AP4616HT7P	MMY-MAP1606HT7P	MMY-MAP1606HT7P	MMY-MAP1406HT7P
MMY-AP4816HT7P	MMY-MAP1606HT7P	MMY-MAP1606HT7P	MMY-MAP1606HT7P

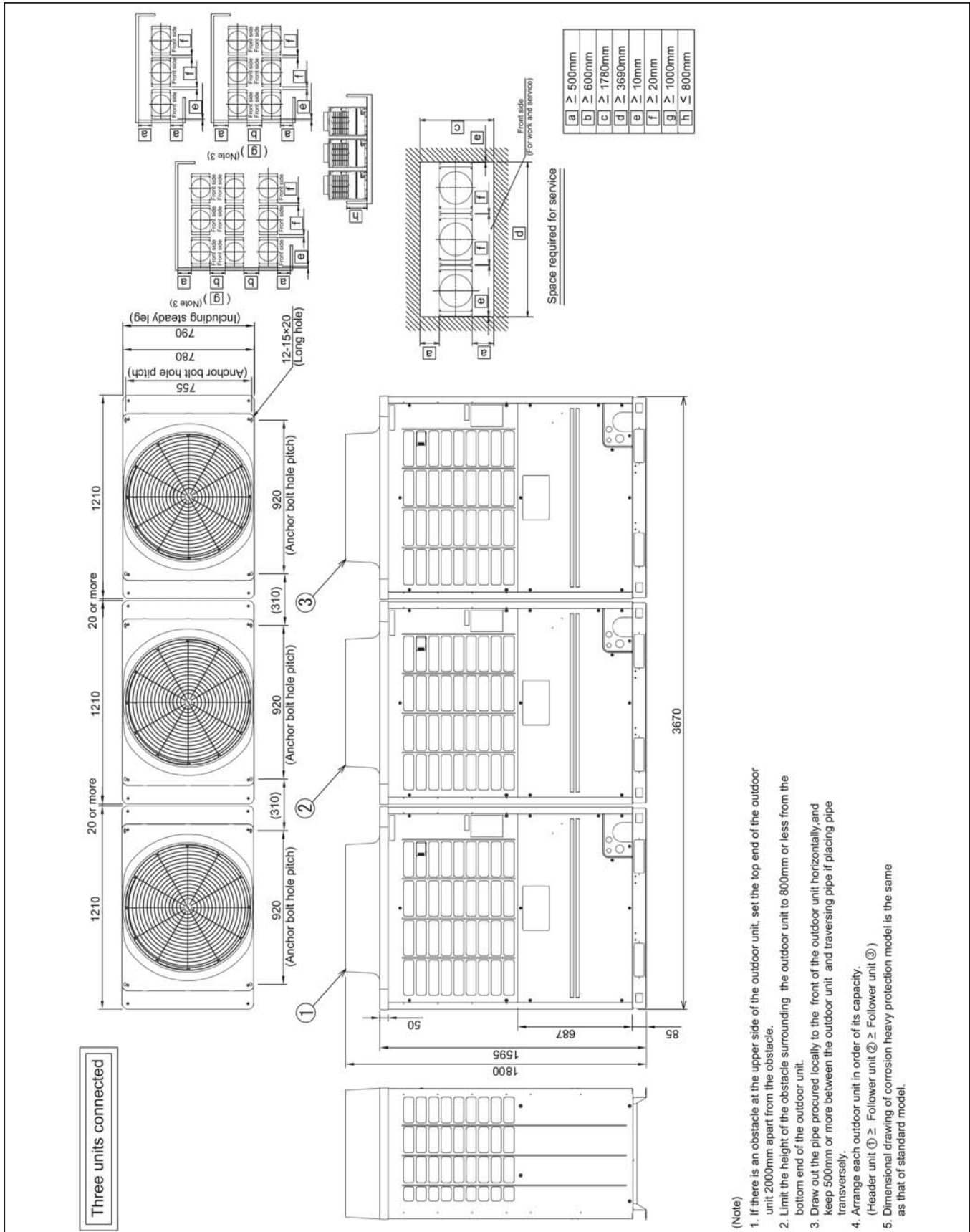



Combination

Model	Outdoor unit		
	(1) Header unit	(2) Follower unit	(3) Follower unit
MMY-AP5016HT7P	MMY-MAP1806HT7P	MMY-MAP1606HT7P	MMY-MAP1606HT7P
MMY-AP5216HT7P	MMY-MAP2006HT7P	MMY-MAP1606HT7P	MMY-MAP1606HT7P
MMY-AP5416HT7P	MMY-MAP2206HT7P	MMY-MAP1606HT7P	MMY-MAP1606HT7P

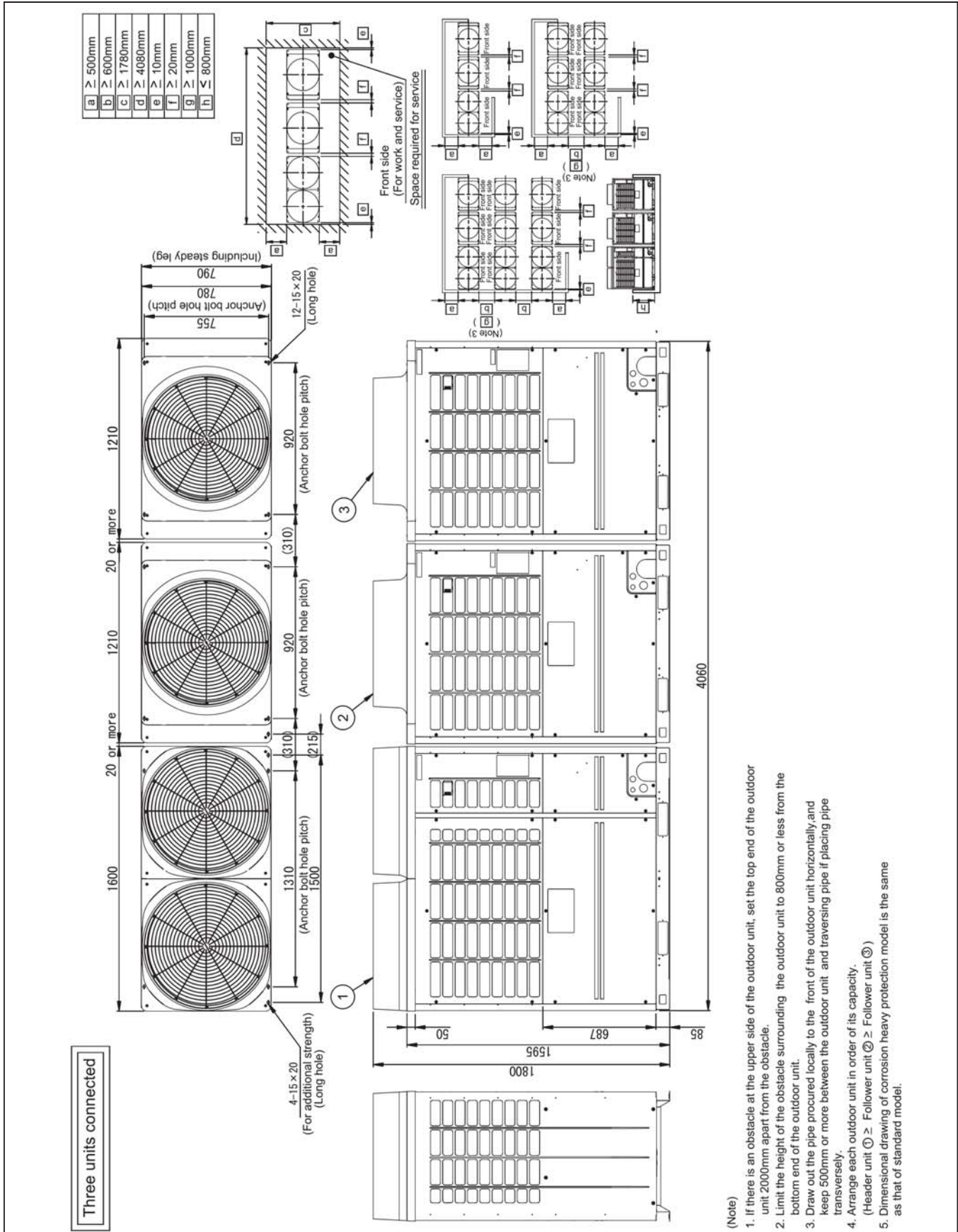



Combination

Model	Outdoor unit		
	(1) Header unit	(2) Follower unit	(3) Follower unit
MMY-AP5426HT7P	MMY-MAP2006HT7P	MMY-MAP2006HT7P	MMY-MAP1406HT7P
MMY-AP5616HT7P	MMY-MAP2006HT7P	MMY-MAP2006HT7P	MMY-MAP1606HT7P
MMY-AP5816HT7P	MMY-MAP2206HT7P	MMY-MAP2006HT7P	MMY-MAP1606HT7P
MMY-AP6016HT7P	MMY-MAP2206HT7P	MMY-MAP2206HT7P	MMY-MAP1606HT7P

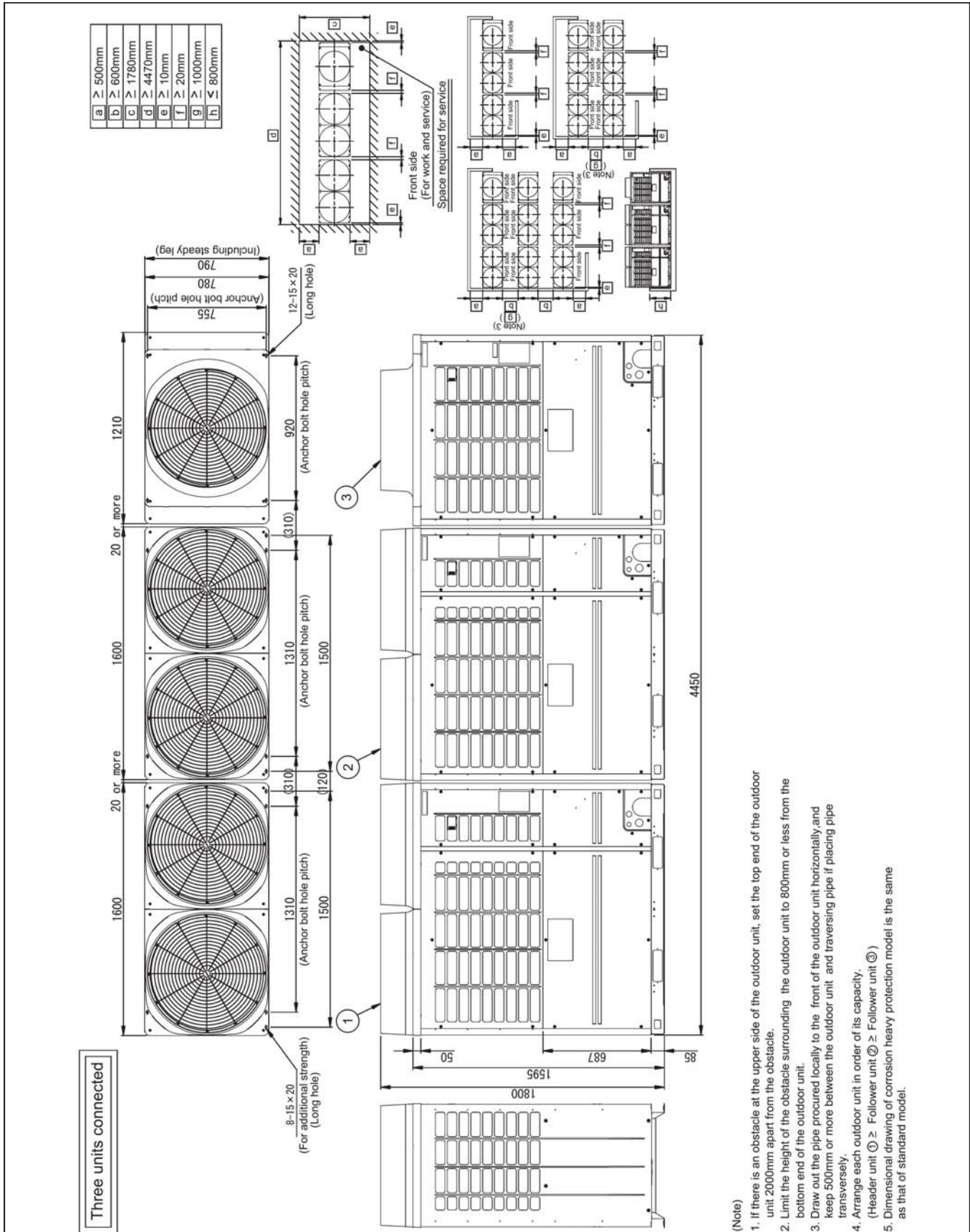

(Note)

1. If there is an obstacle at the upper side of the outdoor unit, set the top end of the outdoor unit 2000mm apart from the obstacle.
2. Limit the height of the obstacle surrounding the outdoor unit to 800mm or less from the bottom end of the outdoor unit.
3. Draw out the pipe procured locally to the front of the outdoor unit horizontally, and keep 500mm or more between the outdoor unit and traversing pipe if placing pipe transversely.
4. Arrange each outdoor unit in order of its capacity.
5. Dimensional drawing of corrosion heavy protection model is the same as that of standard model.

5-3. Center of gravity

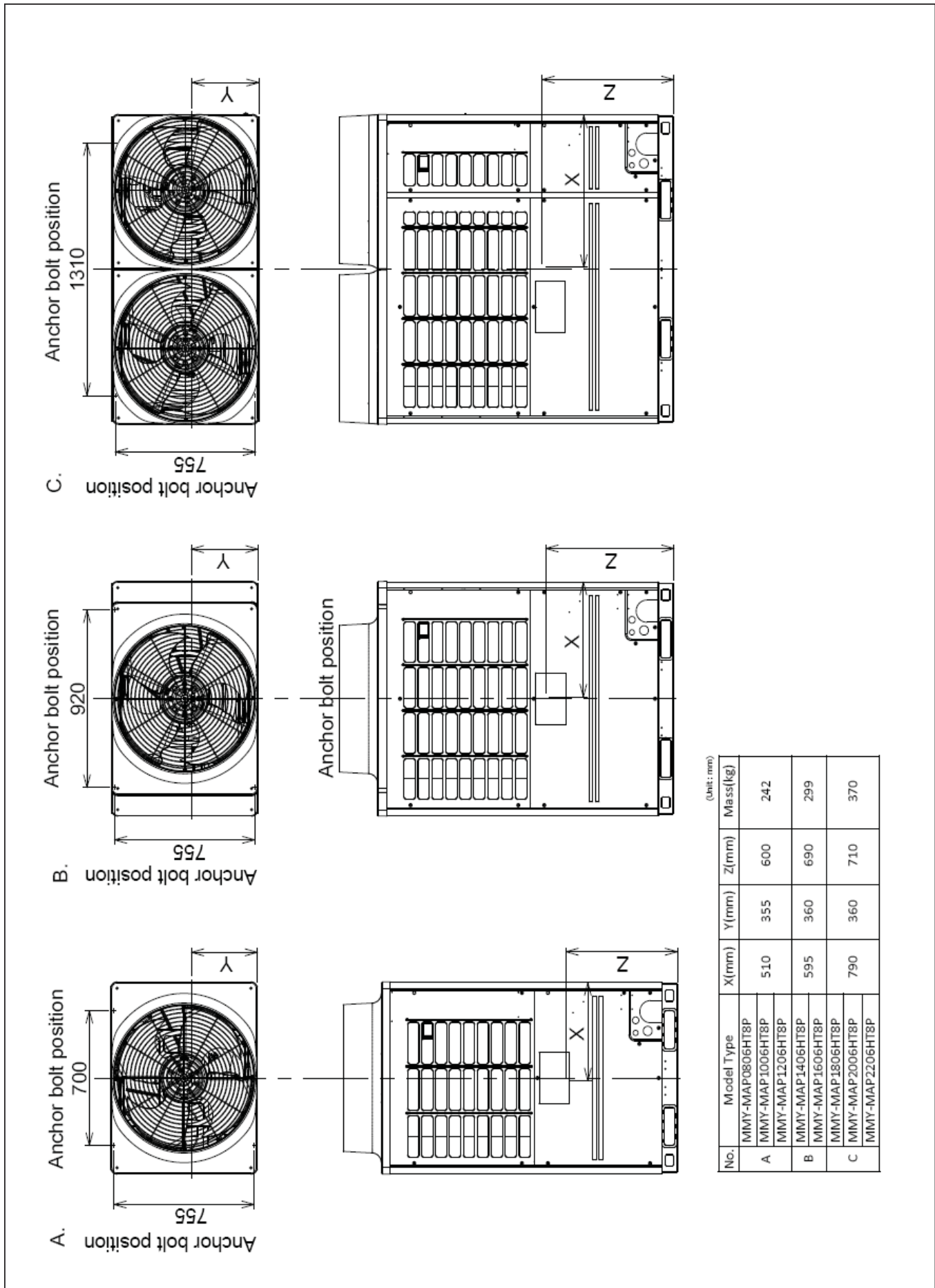

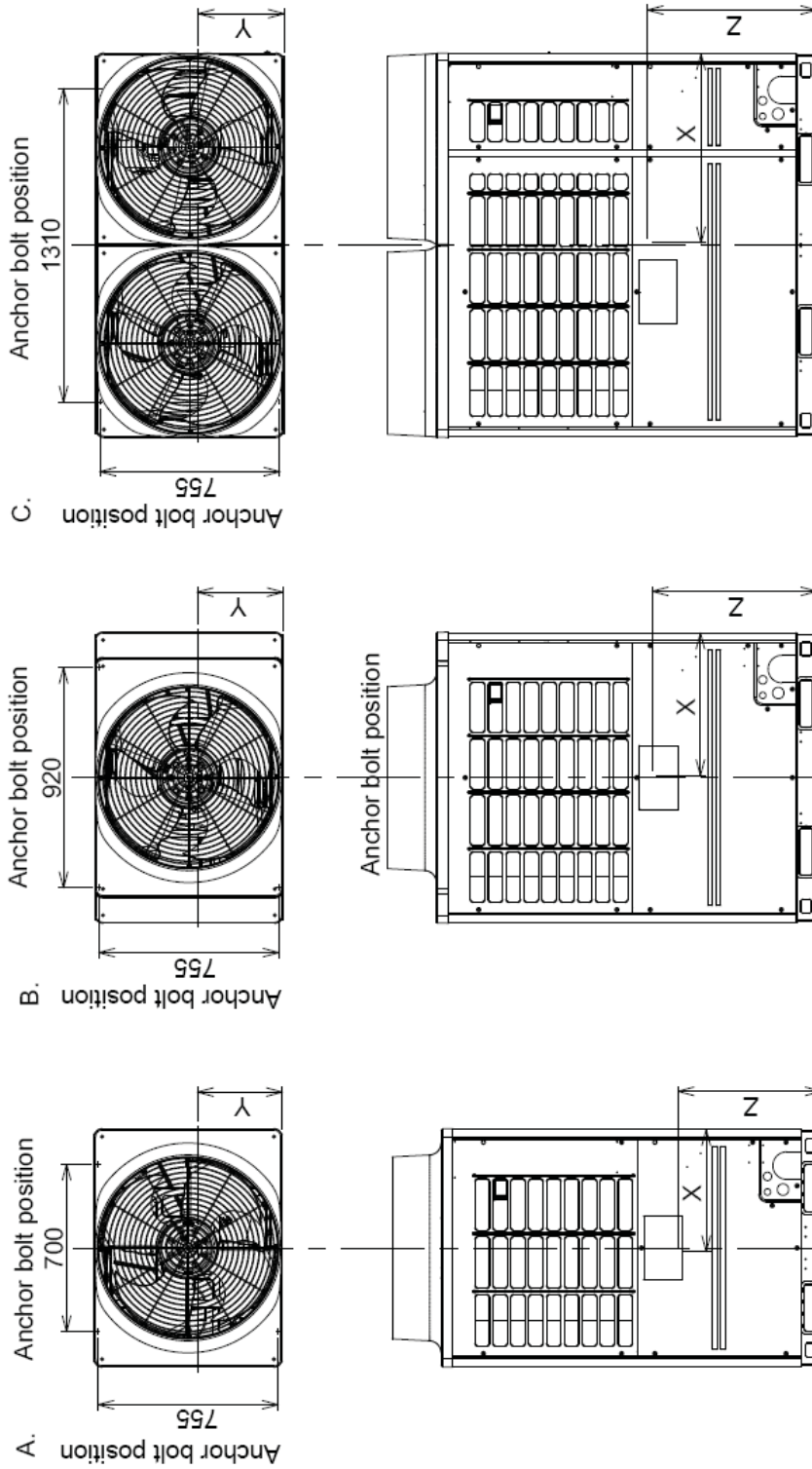

(Unit: mm)

No.	Model Type	X(mm)	Y(mm)	Z(mm)	Mass(kg)
A	IMMY-MAP0806HT7P	510	355	600	242
B	IMMY-MAP1006HT7P	595	360	690	299
C	IMMY-MAP1806HT7P	790	360	710	370

5-4. Branch header / branch joint

• Branch header

RBM-HY1043E, HY1083E, HY2043E, HY2083E

Gas side

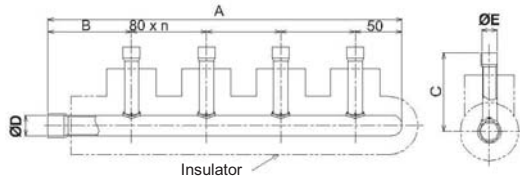

Liquid side

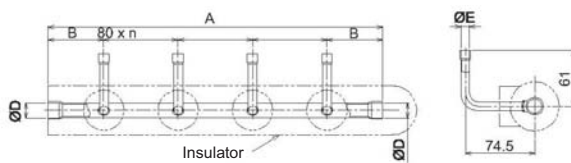

(Unit : mm)

Model		A	B	C	øD	øE	n	Accessory socket Qty
RBM-HY1043E	Gas side	380	90	83.6	22.2	15.9	3	⑥x 4, ⑨x 4, ⑭x 1, ⑱x 1, ⑳x 1
	Liquid side	360	60	-	15.9	9.5	3	①x 4, ⑥x 1, ⑨x 1
RBM-HY1083E	Gas side	700	90	83.6	22.2	15.9	7	⑥x 8, ⑨x 8, ⑭x 1, ⑱x 1, ⑳x 1
	Liquid side	680	60	-	15.9	9.5	7	①x 8, ⑥x 1, ⑨x 1
RBM-HY2043E	Gas side	385.5	95.5	89.3	31.8	15.9	3	⑥x 2, ⑨x 2, ⑳x 1, ㉑x 1
	Liquid side	360	60	-	15.9	9.5	3	①x 2 ⑤①x 1
RBM-HY2083E	Gas side	705.5	95.5	89.3	31.8	15.9	7	⑥x 7, ⑨x 7, ⑳x 1, ㉑x 1
	Liquid side	680	60	-	15.9	9.5	7	①x 7, ⑤①x 1

• Y-shape branch joint

RBM-BY55E, BY105E, BY205E, BY305E

Gas side

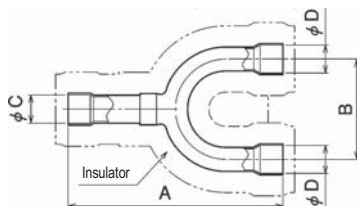

Liquid side

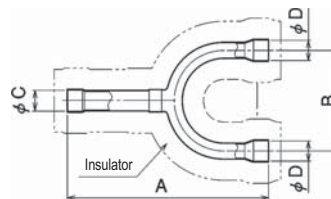

(Unit : mm)

RBM-		A	B	øC	øD	Accessory socket Qty
BY55E	Gas side	160	80	15.9	15.9	⑨x 1, ⑤①x 2, ⑨①x 2
	Liquid side	130	70	9.5	9.5	①x 2te
BY105E	Gas side	170	80	22.2	22.2	⑭x 2, ⑳x 2, ⑨①x 1
	Liquid side	160	80	15.9	15.9	⑨x 1, ⑨①x 1, ⑨②x 1
BY205E	Gas side	200	80	31.8	28.6	⑱x 1, ⑳x 1, ④③x 2, ⑤③x 1, ⑤⑨x 1, ⑨①x 1
	Liquid side	160	80	15.9	15.9	⑨x 1, ⑤①x 2, ⑨②x 1
BY305E	Gas side	220	80	38.1	38.1	④③x 1, ⑥①x 3, ⑥②x 2, ⑦①x 2, ⑦⑤x 1, ⑨①x 1
	Liquid side	170	80	22.2	22.2	⑨②x 1, ⑨③x 3, ⑦⑦x 2

• Branching joint for connection of outdoor units (Set of three kinds of joint)
RBM-BT14E

Gas side

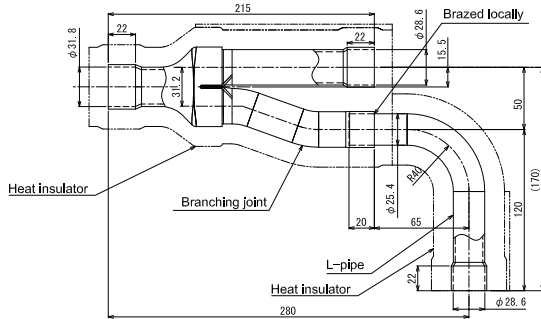

Liquid side

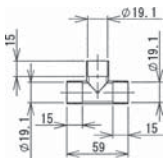

Balance pipe

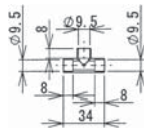

RBM-BT14E	
	Accessory socket Qty
Gas side	②7 x 1, ④3 x 2, ⑤9 x 1
Liquid side	⑩ x 2, ⑬ x 1

RBM-BT24E

Gas side

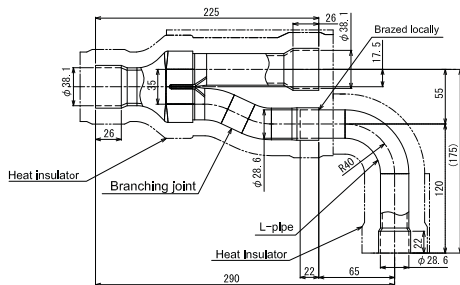

Liquid side

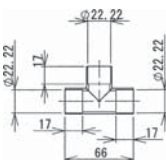

Balance pipe

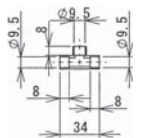

RBM-BT24E	
	Accessory socket Qty
Gas side	④3 x 1, ⑥1 x 2, ⑥2 x 2, ⑦1 x 1, ⑦3 x 1
Liquid side	⑭ x 2, ⑱ x 2, ⑤5 x 1, ⑦0 x 1

(Unit : mm)

• Accessory socket

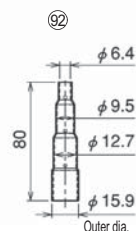
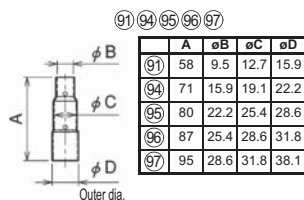
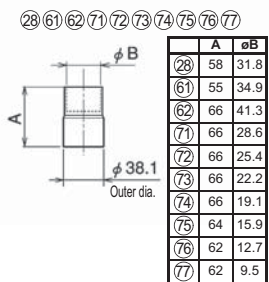
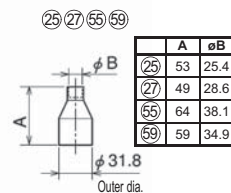
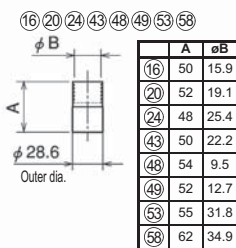
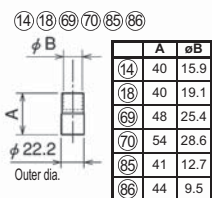
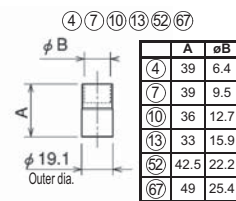
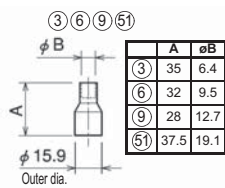
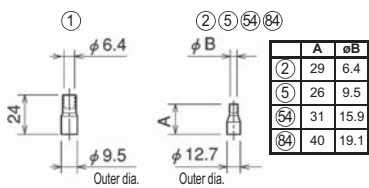

Closure tube



(Unit : mm)

5-5. Refrigerant cycle diagram

MMY-MAP0806HT8/7P, MMY-MAP1006HT8/7P, MMY-MAP1206HT8/7P

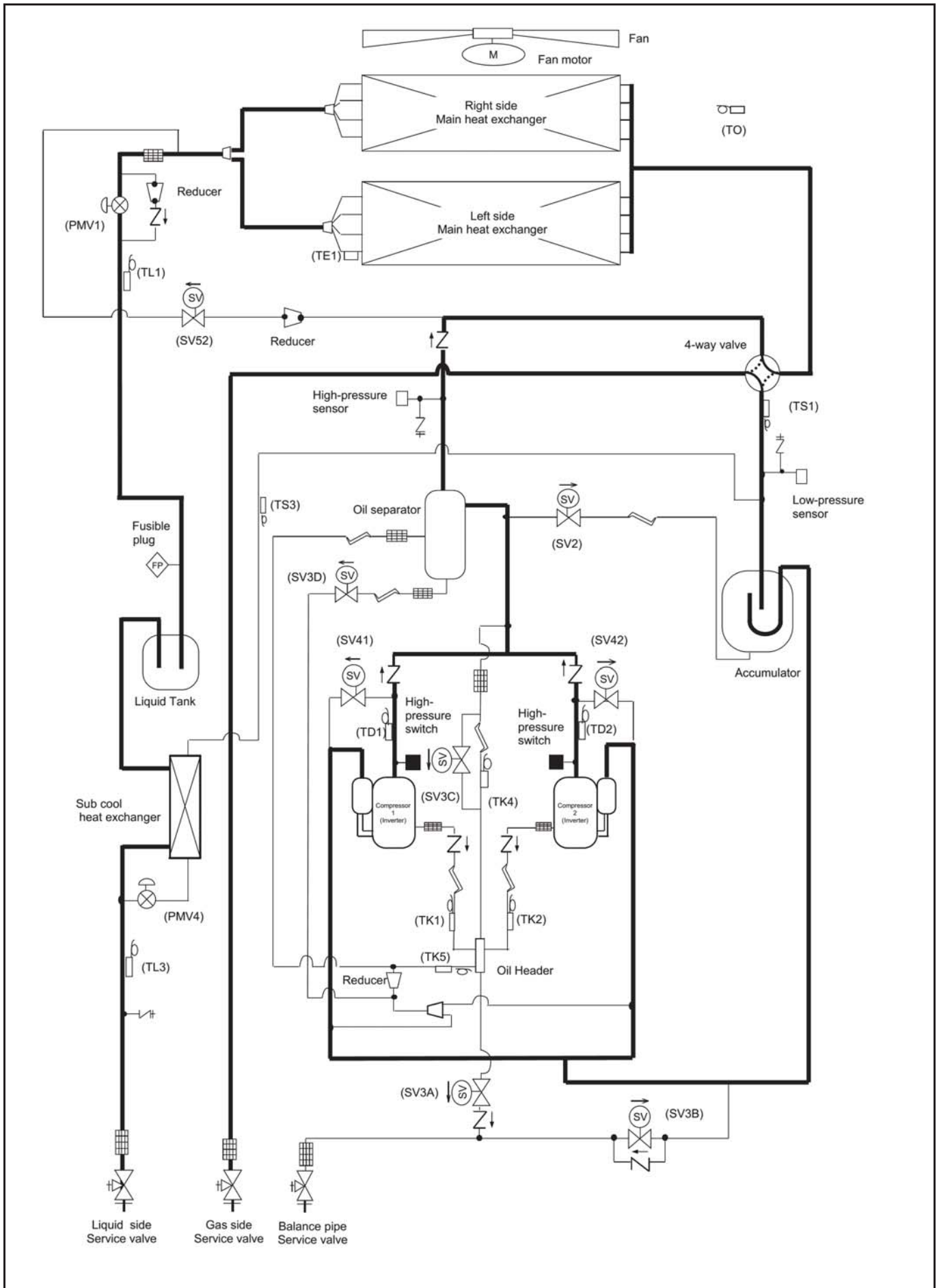

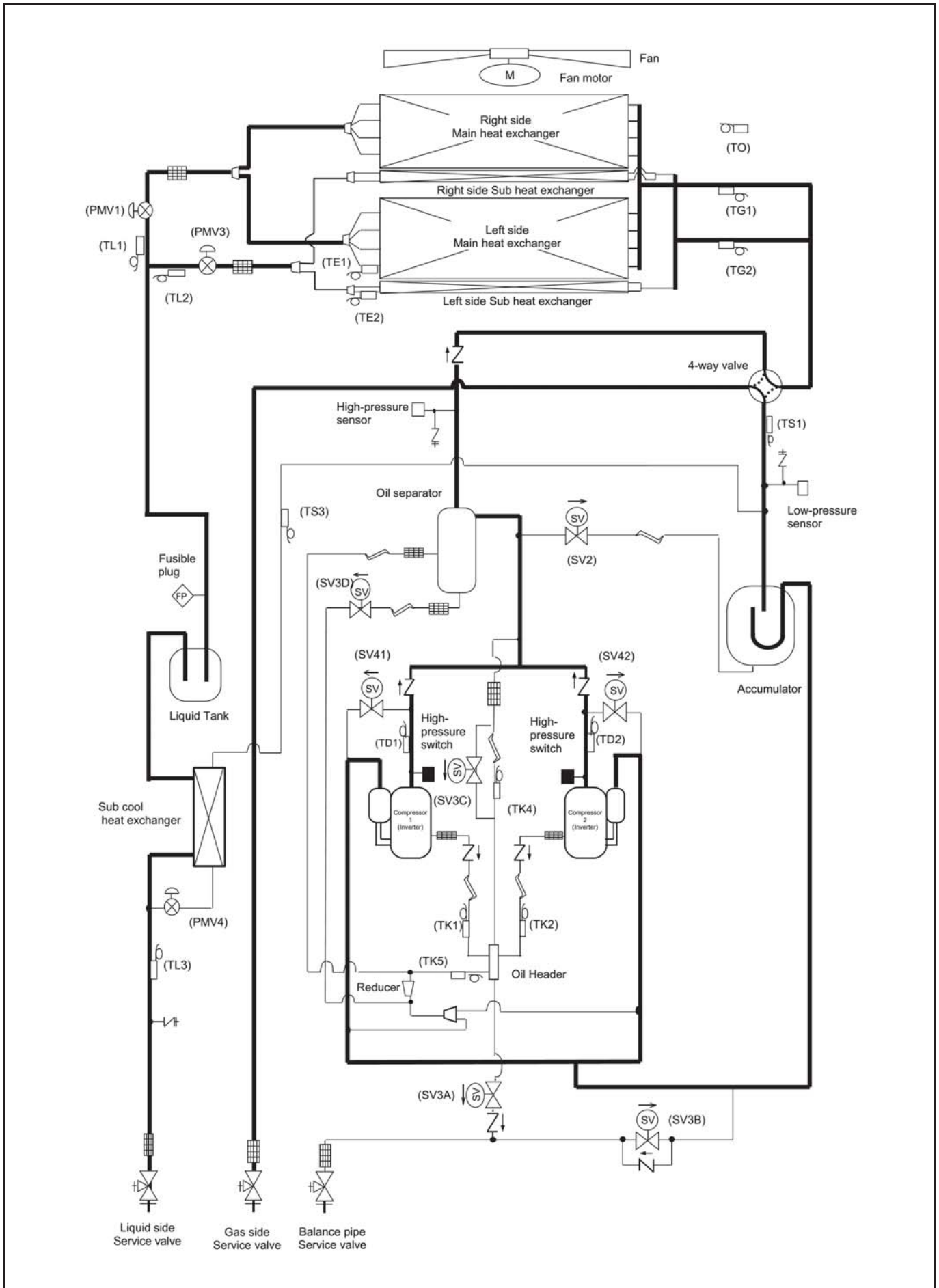

MMY-MAP1806HT8/7P, MMY-MAP2006HT8/7P, MMY-MAP2206HT8/7P

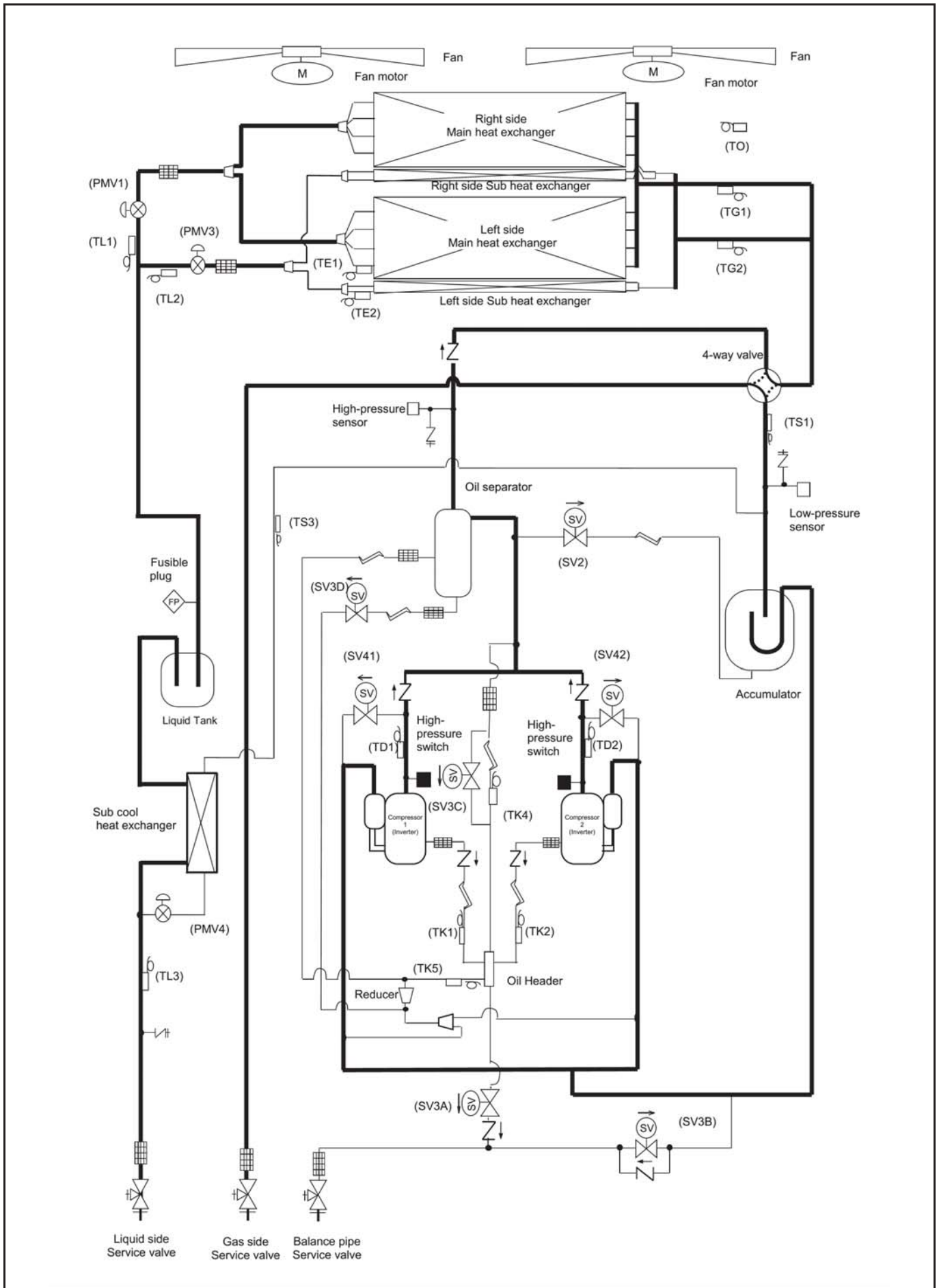



5-6. Wiring diagram

MMY-MAP0806HT8P, MMY-MAP1006HT8P, MMY-MAP1206HT8P

Symbol	Parts name
MCC-1669	Inverter P.C. Board (Compressor)
MCC-1673	Interface Control P.C. Board
MCC-1608A	Noise filter P.C. Board A
MCC-1608B	Noise filter P.C. Board B
MCC-1659	Inverter P.C. Board (Fan)
MCC-1667	NFC P.C. Board

Symbol	Parts name
4WV1	4-way valve coil
63H1,63H2	High pressure switch
CM1,CM2	Compressor
CNR	Relay connector
CN***	Connector
(MCC-1669)	Fuse (Compressor)
F01, F02	Fuse (Interface)
F01, F02	T6.3A, 250V ~
(MCC-1608A)	Fuse (Noise filter)
F01, F02, F03	T6.3A, 250V ~
(MCC-1659)	Fuse (Fan)
F01	6.3A 750VDC
FM	Fan motor
HEATER1,HEATER2	Compressor case heater
A,HEATER	Accumulator case heater
L-CM1,L-CM2	Reactor for compressor
Mp-CIT1	Magnet contactor
PD	Pressure sensor (High)
PS	Pressure sensor (Low)
PMV1	Pressure motor valve (Main)
PMV4	Pressure motor valve (Sub cool)
RB	Rush current protect resistor
SV2,SV3A,SV3B,SV3C	2-way valve coil
SV3D,SV41,SV42,SV52	2-way valve coil
SW01, SW02, SW03	Rotary switch
SW04, SW05, SW15	Push button switch
SW06,SW07, SW09, SW10	Dip switch
SW11, SW12, SW13, SW14	Dip switch
SW16, SW17, SW30, SW800	Dip switch
TD1, TD2	Pipe temp. sensor (Discharge)
TE1	Heat exchange temp. sensor
TK1, TK2, TK4, TK5	Oil temp. sensor
TL1, TL3	Liquid temp. sensor
TO	Air temp. sensor
TS1, TS3	Pipe temp. sensor (Suction)
TB1	Terminal block (power supply)
TB2	Terminal block (control wiring)

Symbol	Parts name
⊕	Field wiring
⊕	Protective earth
⊕	Terminal block
⊕	Terminal
⊕	Connector
⊕	P.C. board
⊕	CNR

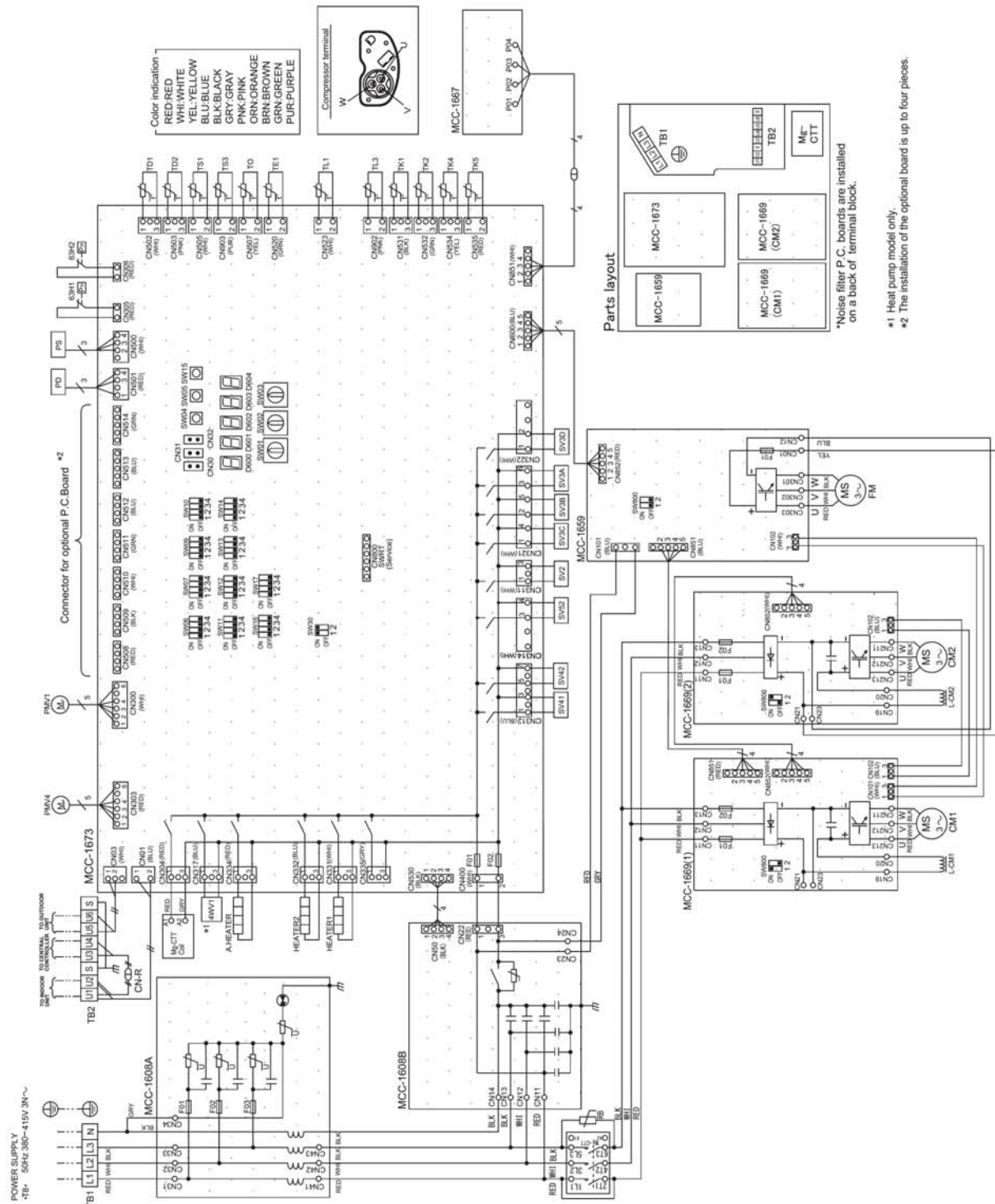

- *Noise filter P.C. boards are installed on a back of terminal block.
- #1 Heat pump model only.
- #2 The installation of the optional board is up to four pieces.



P.C Board	Symbol	Parts name
MCC-1669		Inverter P.C Board (Compressor)
MCC-1673		Interface Control P.C Board
MCC-1608A		Noise filter P.C Board A
MCC-1608B		Noise filter P.C Board B
MCC-1659		Inverter P.C Board (Fan)
MCC-1667		NFC P.C Board

Symbol	Parts name
4WV1	4-way valve coil
63H1.63H2	High pressure switch
CM1 CM2	Compressor
CN-R	Relay connector
CN***	Connector
(MCC-1669)	Fuse (Compressor)
F01.F02	31.5A 50V ~
(MCC-1673)	Fuse (Interface)
F01.F02	T6.3A 250V ~
(MCC-1608A)	Fuse (Noise filter)
F01.F02.F03	T6.3A 250V ~
(MCC-1659)	Fuse (Fan)
F01	6.3A 150VDC
FM	Fan motor

Symbol	Parts name
HEATER1 HEATER2	Compressor case heater
A.HEATER	Accumulator case heater
L-CMT1.L-CM2	Reactor for compressor
Mg-CIT1	Magnet contactor
PD	Pressure sensor (High)
PS	Pressure sensor (Low)
PMV1	Pulse motor valve (Main)
PMV3	Pulse motor valve (Sub)
PMV4	Pulse motor valve (Sub-cool)
RB	Rush current protect resistor
SV2.SV3A.SV3B.SV3C	2-way valve coil
SV3D.SV41.SV42	Rotary switch
SW01.SW02.SW03	Rotary switch
SW04.SW05.SW15	Push button switch
SW06.SW07.SW09.SW10	
SW11.SW12.SW13.SW14	
SW16.SW17.SW30.SW800	Dip switch
TD1.TD2	Pipe temp. sensor (Discharge)
TE1.TE2	Heat exchange temp. sensor
TK1.TK2.TK4.TK5	Oil temp. sensor
TL1.TL2.TL3	Liquid temp. sensor
TO	Air temp. sensor
TS1.TS3	Pipe temp. sensor (Suction)
TG1.TG2	Gas temp. sensor
TB1	Terminal block(power supply)
TB2	Terminal block(control wiring)
TB3	Terminal block(internal wiring connector)

Field wiring	Symbol
Protective earth	⊕
Terminal block	□
Terminal	○
Connector	⊗
P.C board	⊞
CN-R	⊞

Color indication
 RED:RED
 WHI:WHITE
 YEL:YELLOW
 BLU:BLUE
 BLK:BLACK
 GRY:GRAY
 PNK:PINK
 ORN:ORANGE
 BRN:BROWN
 GRN:GREEN
 PUR:PURPLE

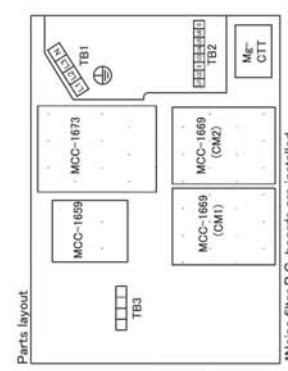
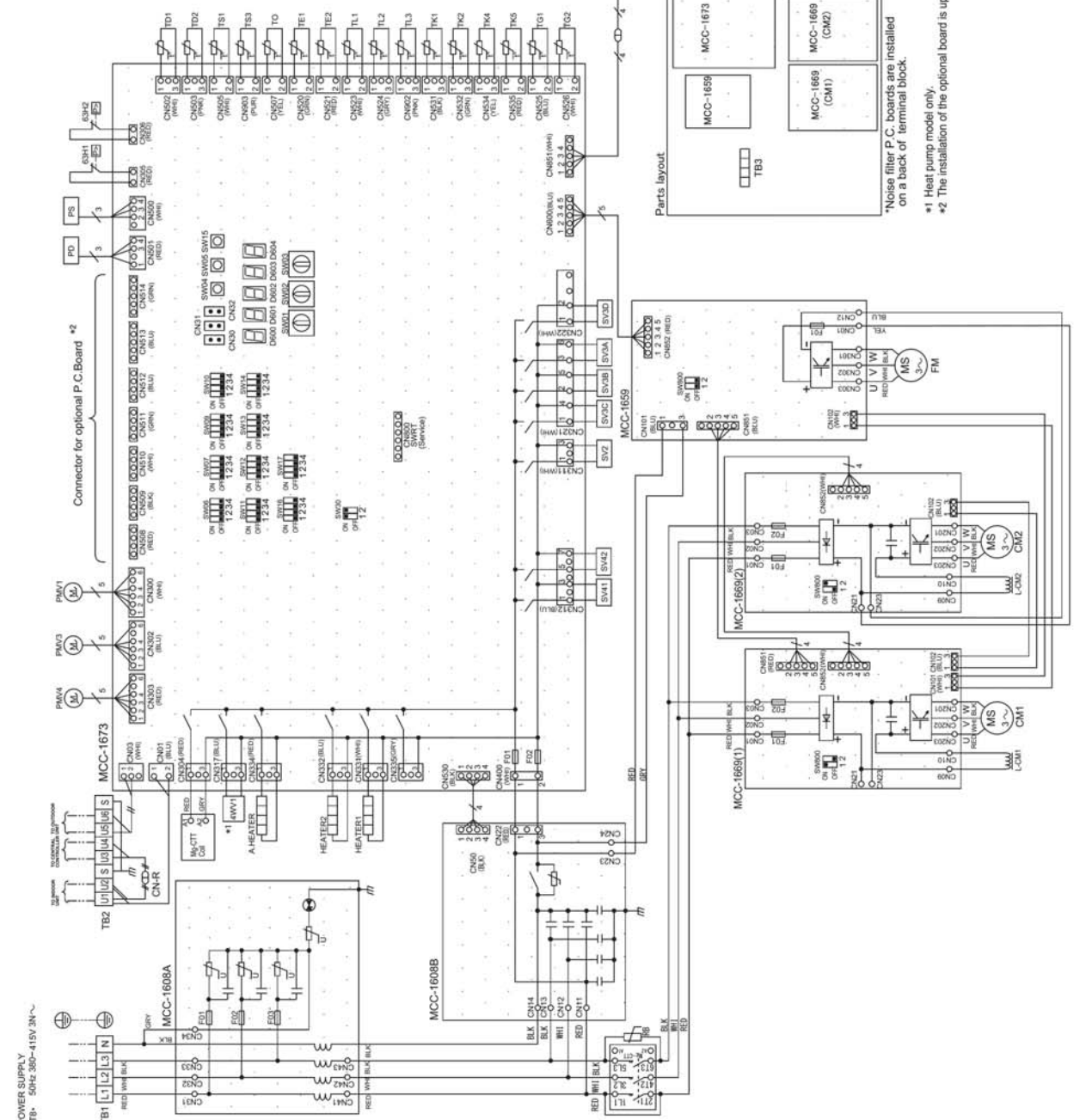
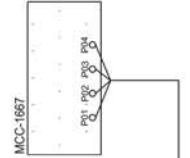

*Noise filter P.C. boards are installed on a back of terminal block.

- #1 Heat pump model only.
- #2 The installation of the optional board is up to four pieces.



P.C.Board Symbol	Parts name
MCC-1660	Inverter P.C.Board (Compressor)
MCC-1673	Interface Control P.C.Board
MCC-1608A	Noise filter P.C.Board A
MCC-1608B	Noise filter P.C.Board B
MCC-1659	Inverter P.C.Board (Fan)
MCC-1667	NFC P.C.Board

Symbol	Parts name
4WV1	4-way valve coil
63H1.63H2	High pressure switch
CM1,CM2	Compressor
CNR	Relay connector
CN***	Connector
(MCC-1660)	Fuse (Compressor)
F01.F02	40A 500V ~
(MCC-1673)	Fuse (Interface)
F01.F02	T6.3A 250V ~
(MCC-1608A)	Fuse (Noise filter)
F01.F02.F03	T6.3A 250V ~
(MCC-1659)	Fuse (Fan)
F01	6.3A 750VDC
FM1, FM2	Fan motor
HEATER1, HEATER2	Compressor case heater
A, HEATER	Accumulator case heater
L-CM1, L-CM2	Reactor for compressor
Mg-C1T1, Mg-C1T2	Magnet contactor
PD	Pressure sensor (High)
PS	Pressure sensor (Low)
PMV1	Pulse motor valve (Main)
PMV3	Pulse motor valve (Sub)
PMV4	Pulse motor valve (Sub coil)
RB	Rush current protect resistor
V2, SV3A, SV3B, SV3C SV3D, SV41, SV42	2-way valve coil
SW01, SW02, SW03	Rotary switch
SW04, SW05, SW15	Push button switch
SW06, SW07, SW09, SW10	Dip switch
SW11, SW12, SW13, SW14	
SW16, SW17, SW30, SW800	
TD1, TD2	Pipe temp. sensor (Discharge)
TE1, TE2	Heat exchange temp. sensor
TK1, TK2, TK4, TK5	Oil temp. sensor
TL1, TL2, TL3	Liquid temp. sensor
TO	Air temp. sensor
TS1, TS3	Pipe temp. sensor (Suction)
TG1, TG2	Gas temp. sensor
TB1	Terminal block(power supply)
TB2	Terminal block(control wiring)
TB3	Terminal block(internal wiring connector)

Field wiring	
	Protective earth
	Terminal block
	Terminal
	Connector
	P.C.board
	CNR

Color indication
 RED-RED
 WHI-WHITE
 YEL-YELLOW
 BLK-BLACK
 GRY-GRAY
 PNK-PINK
 ORN-ORANGE
 BRN-BROWN
 GRN-GREEN
 PUR-PURPLE

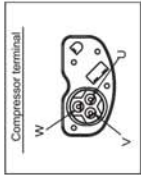

MCC-1667

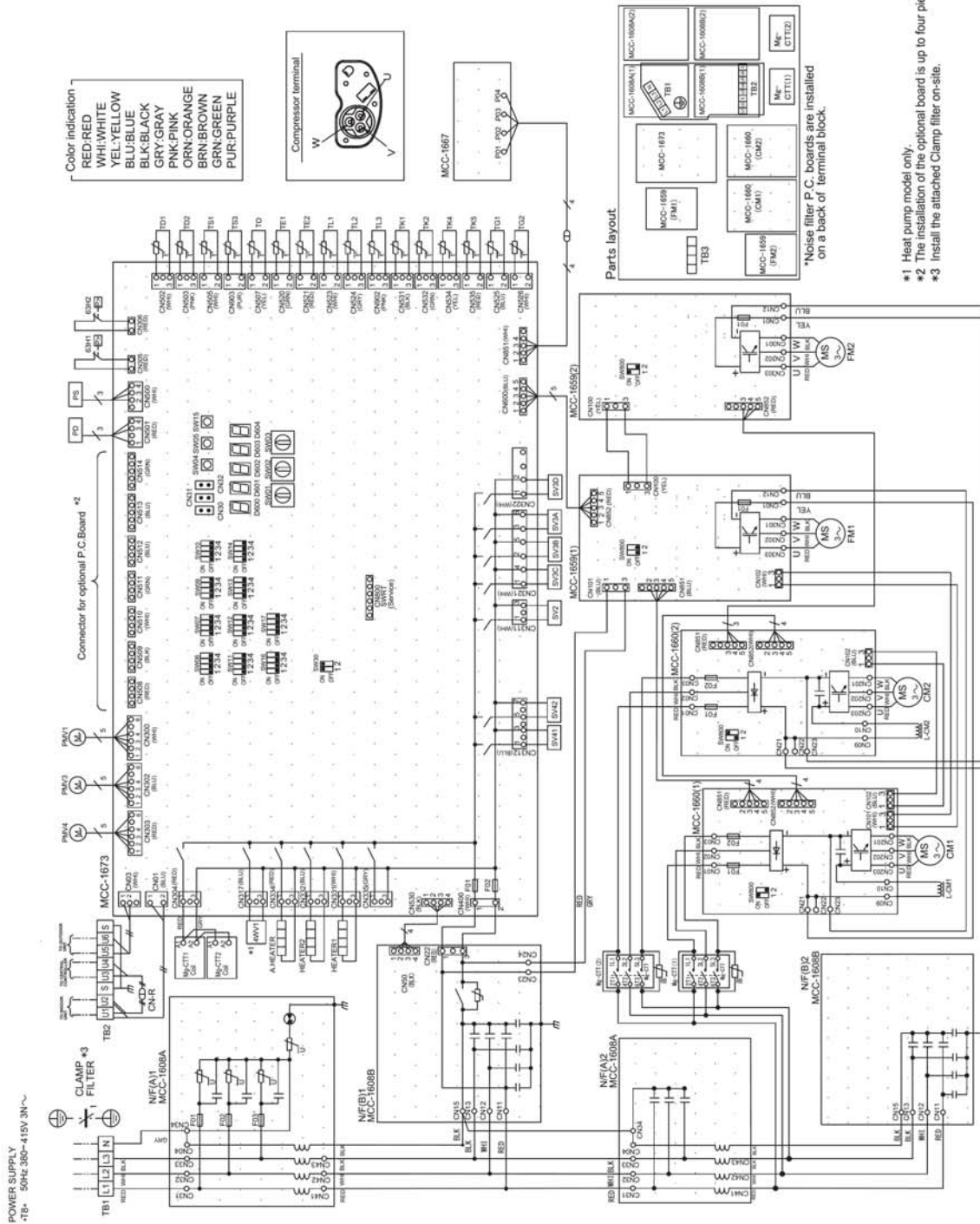

*Noise filter P.C. boards are installed on a back of terminal block.

- *1 Heat pump model only.
- *2 The installation of the optional board is up to four pieces.
- *3 Install the attached Clamp filter on-site.



MMY-MAP0806HT7P, MMY-MAP1006HT7P, MMY-MAP1206HT7P

Symbol	Parts name
MCC-1669	Inverter P.C. Board (Compressor)
MCC-1673	Interface Control P.C. Board
MCC-1608A	Noise filter, P.C. Board A
MCC-1608B	Noise filter, P.C. Board B
MCC-1659	Inverter P.C. Board (Fan)
MCC-1667	NFC P.C. Board

Symbol	Parts name
4WV1	4-way valve coil
63H1,63H2	High pressure switch
CM1,CM2	Compressor
CNR	Relay connector
CN***	Connector
(MCC-1669)	Fuse (Compressor)
F01,F02	Fuse (Interface)
F01,F02	T6.3A 250V ~
(MCC-1608A)	Fuse (Noise filter)
F01,F02,F03	T6.3A 250V ~
(MCC-1659)	Fuse (Fan)
F01	6.3A 750VDC
FM	Fan motor
HEATER1,HEATER2	Compressor case heater
A,HEATER	Accumulator case heater
L-CM1,L-CM2	Reactor for compressor
Mg-C,T	Magnet contactor
PD	Pressure sensor (High)
PS	Pressure sensor (Low)
PMV1	Pulse motor valve (Main)
PMV4	Pulse motor valve (Sub cool)
RB	Rush current protect resistor
SV2,SV3A,SV4B,SV3C,SV3D,SV41,SV42,SV52	2-way valve coil
SW01,SW02,SW03	Rotary switch
SW04,SW05,SW15	Push button switch
SW06,SW07,SW09,SW10,SW11,SW12,SW13,SW14,SW16,SW17,SW30,SW800	Dip switch
TD1,TD2	Pipe temp. sensor (Discharge)
TE1	Heat exchange temp. sensor
TK1,TK2,TK4,TK5	Oil temp. sensor
TL1,TL3	Liquid temp. sensor
TO	Air temp. sensor
TS1,TS3	Pipe temp. sensor (Suction)
TB1	Terminal block(power supply)
TB2	Terminal block(control wiring)

Field wiring
Protective earth
Terminal block
Terminal
Connector
P.C. board
CN-R

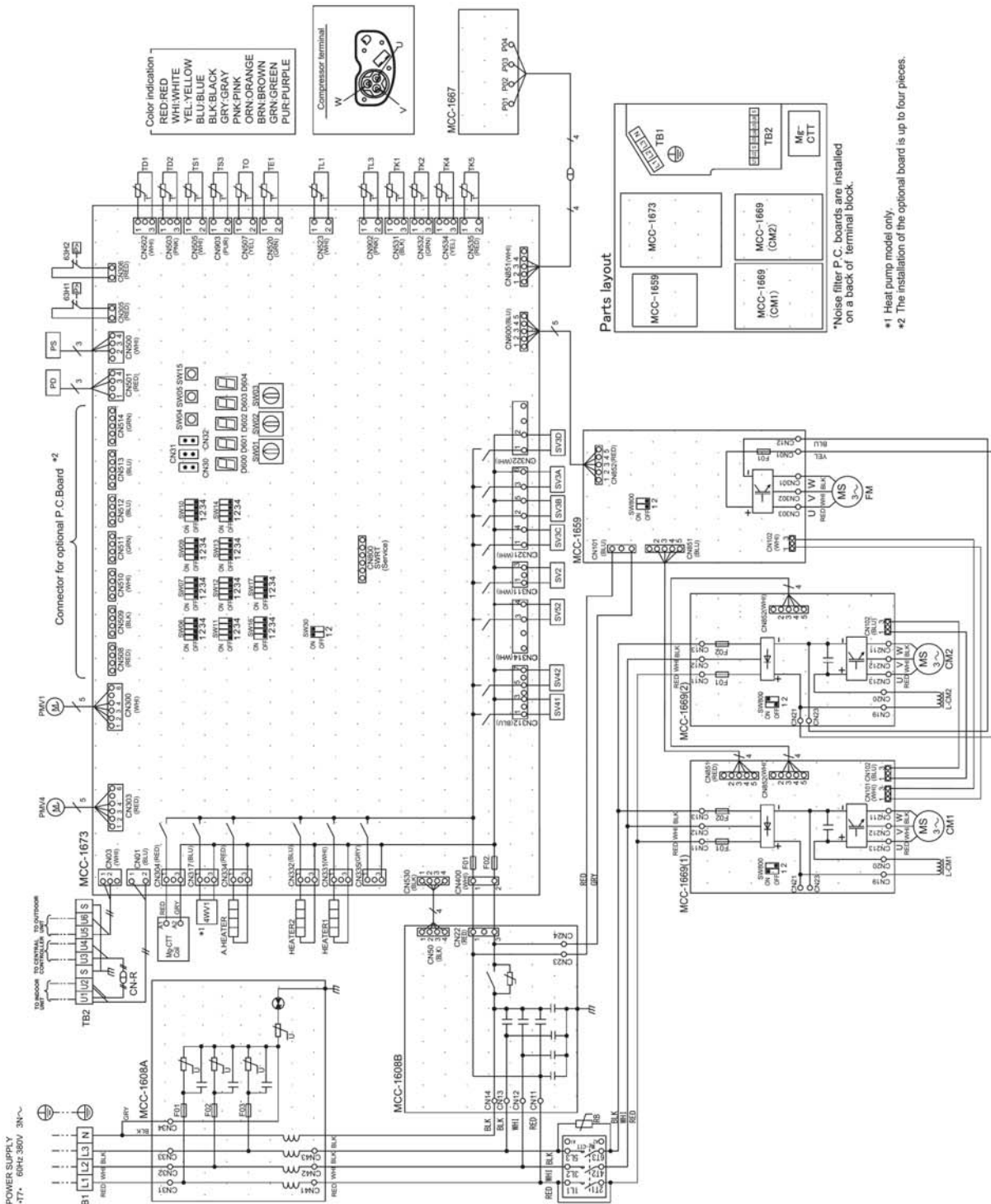

Color indication
 RED-RED
 WHI-WHITE
 YEL-YELLOW
 BLU-BLUE
 BLK-BLACK
 GRY-GRAY
 PNK-PINK
 ORN-ORANGE
 BRN-BROWN
 GRN-GREEN
 PUR-PURPLE

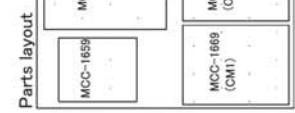
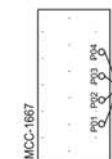

*Noise filter P.C. boards are installed on a back of terminal block.

- *1 Heat pump model only.
- *2 The installation of the optional board is up to four pieces.



Symbol	Parts name
MCC-1669	Inverter P.C Board (Compressor)
MCC-1673	Interface Control P.C Board
MCC-1608A	Noise filter P.C Board A
MCC-1608B	Noise filter P.C Board B
MCC-1669	Inverter P.C Board (Fan)
MCC-1667	NFC P.C Board

Symbol	Parts name
4HW1	4-way valve coil
63H1.63H2	High pressure switch
CM1 CM2	Compressor
CN-R	Relay connector
CN***	Connector
(MCC-1669)	Fuse (Compressor)
F01 F02	31.5A 500V ~
(MCC-1673)	Fuse (Interface)
F01 F02	T6.3A 250V ~
(MCC-1608A)	Fuse (Noise filter)
F01 F02 F03	T6.3A 250V ~
(MCC-1669)	Fuse (Fan)
F01	6.3A 150VDC
FM	Fan motor
HEATER1 HEATER2	Compressor case heater
A HEATER	Accumulator case heater
L-CM1 L-CM2	Reactor for compressor
Mg-C1T1	Magnet connector
PD	Pressure sensor (High)
PS	Pressure sensor (Low)
PMV1	Pulse motor valve (Main)
PMV3	Pulse motor valve (Sub)
PMV4	Pulse motor valve (Sub-cool)
RB	Rush current protect resistor
SV2 SV3A SV3B SV3C SV3D SV41 SV42	2-way valve coil
SW01 SW02 SW03	Rotary switch
SW04 SW05 SW15	Push button switch
SW06 SW07 SW09 SW10	
SW11 SW12 SW13 SW14	
SW16 SW17 SW30 SW600	Dip switch
TD1 TD2	Pipe temp. sensor (Discharge)
TE1 TE2	Heat exchange temp. sensor
TK1 TK2 TK4 TK5	Oil temp. sensor
TL1 TL2 TL3	Liquid temp. sensor
TO	Air temp. sensor
TS1 TS3	Pipe temp. sensor (Suction)
TG1 TG2	Gas temp. sensor
TB1	Terminal block(power supply)
TB2	Terminal block(control wiring)
TB3	Terminal block(main wiring connector)

Symbol	Field wiring
⊕	Protective earth
□	Terminal block
○	Terminal
□	Connector
□	P.C board
○	CN-R

Color indication
 RED:RED
 WH:WHITE
 YEL:YELLOW
 BLU:BLUE
 BLK:BLACK
 GRY:GRAY
 PNK:PINK
 ORN:ORANGE
 BRN:Brown
 GRN:GREEN
 PUR:Purple

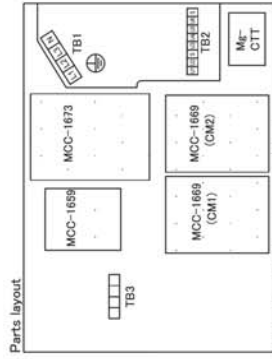
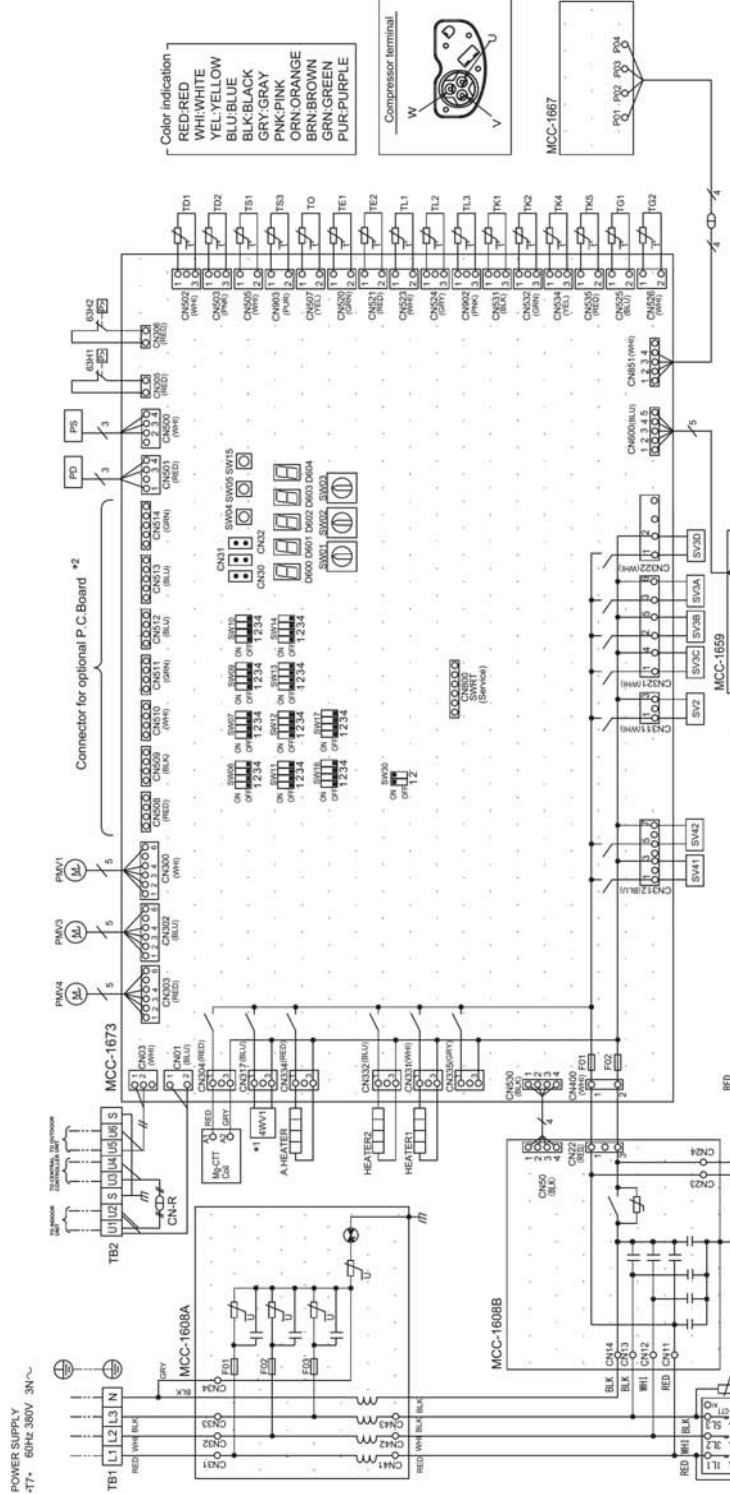
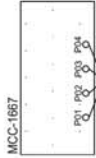

*Noise filter P.C. boards are installed on a back of terminal block.

- *1 Heat pump model only.
- *2 The installation of the optional board is up to four pieces.



MMY-MAP1806HT7P, MMY-MAP2006HT7P, MMY-MAP2206HT7P

Symbol	Parts name
MCC-1660	Inverter P.C Board (Compressor)
MCC-1673	Interface Control P.C Board
MCC-1608A	Noise filter P.C Board A
MCC-1608B	Noise filter P.C Board B
MCC-1659	Inverter P.C Board (Fan)
MCC-1667	NFC P.C Board

Symbol	Parts name
4WV1	4-way valve coil
6SH1.63H2	High pressure switch
CM1.CM2	Compressor
CNR	Relay connector
CN***	Connector
F01.F02	Fuse (Compressor)
(MCC-1673)	Fuse (Interface)
F01.F02	Fuse (Noise filter)
(MCC-1608A)	Fuse (Noise filter)
F01.F02.F03	Fuse (Fan)
(MCC-1659)	Fuse (Fan)
F01	6.3A 750VDC
FM1, FM2	Fan motor
HEATER1, HEATER2	Compressor case heater
A, HEATER	Accumulator case heater
L-CM1, L-CM2	Reactor for compressor
Mg-CTT1, Mg-CTT2	Magnet contactor
PD	Pressure sensor (High)
PS	Pressure sensor (Low)
PMV1	Pulse motor valve (Main)
PMV3	Pulse motor valve (Sub)
PMV4	Pulse motor valve (Sub cool)
RB	Rush current protect resistor
SV2, SV3A, SV3B, SV3C	2-way valve coil
SV3D, SV41, SV42	Rotary switch
SW01, SW02, SW03	Rotary switch
SW04, SW05, SW15	Push button switch
SW06, SW07, SW09, SW10	Push button switch
SW11, SW12, SW13, SW14	Dip switch
SW16, SW17, SW30, SW600	Dip switch
TD1, TD2	Pipe temp. sensor (Discharge)
TE1, TE2	Heat exchange temp. sensor
TK1, TK2, TK4, TK5	Oil temp. sensor
TL1, TL2, TL3	Liquid temp. sensor
TO	Air temp. sensor
TS1, TS3	Pipe temp. sensor (Suction)
TG1, TG2	Gas temp. sensor
TB1	Terminal block(power supply)
TB2	Terminal block(control wiring)
TB3	Terminal block(internal wiring connector)

Symbol	Field wiring
	Protective earth
	Terminal block
	Terminal
	Connector
	P.C board
	CNR

Color indication
 RED-WHITE
 YEL-YELLOW
 BLU-BLUE
 BLK-BLACK
 GRN-GRAY
 PNK-PINK
 BRN-ORANGE
 BRN-BROWN
 GRN-GREEN
 PUR-PURPLE

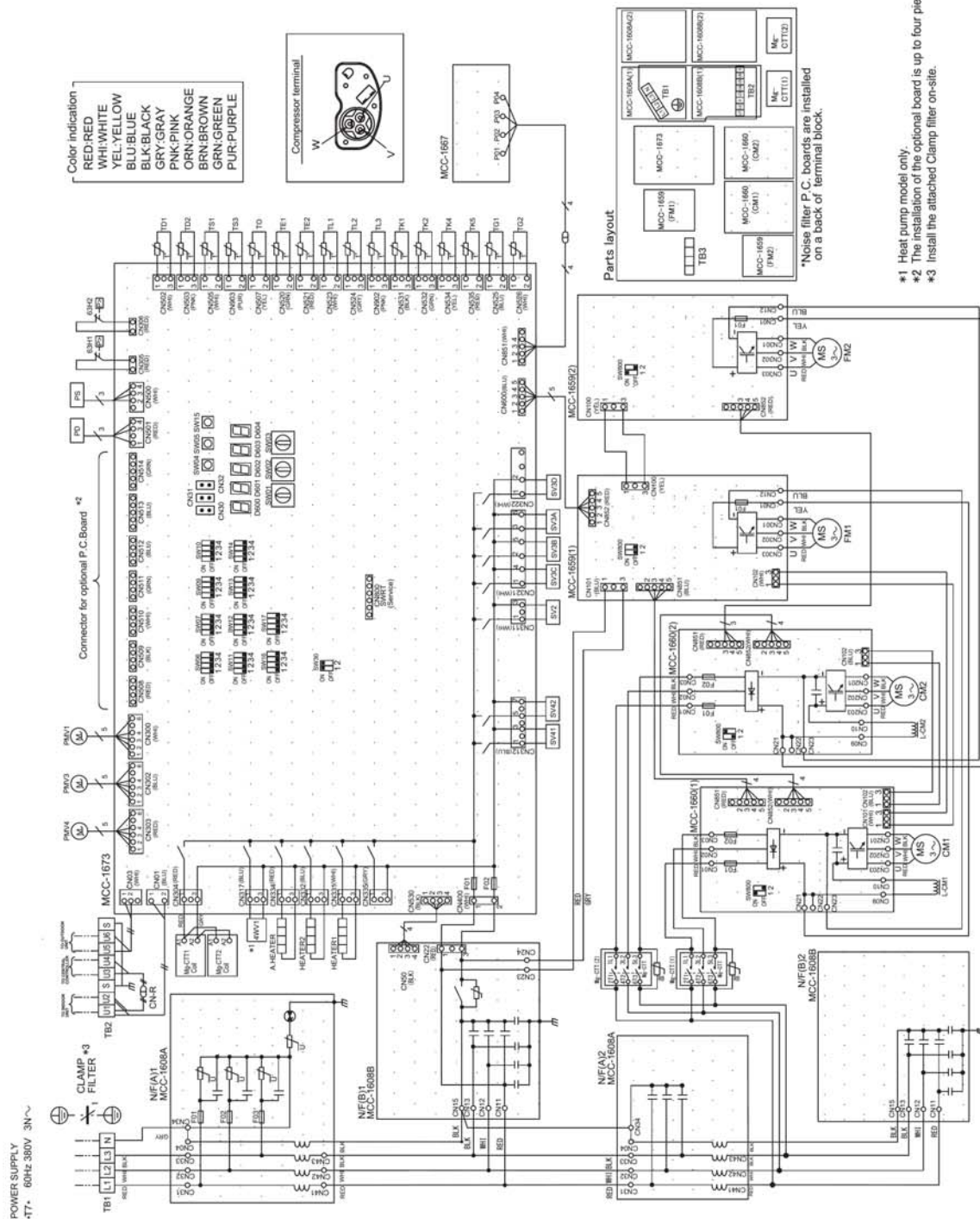

*Noise filter P.C. boards are installed on a back of terminal block.

- *1 Heat pump model only.
- *2 The installation of the optional board is up to four pieces.
- *3 Install the attached Clamp filter on-site.

5-7. Connecting diagram

Single unit connected

Model : MMY-AP***6HT8P

①	Outdoor unit (Header unit)
②	—
③	Indoor unit
④	Remote controller
⑤	Central remote controller (option)
⑥	Main switch (Fuse)
⑦	Circuit breaker (Earth leakage breaker)
⑧	Pull box

W1 : Control wiring between indoor and outdoor units
W2 : Control wiring between indoor units

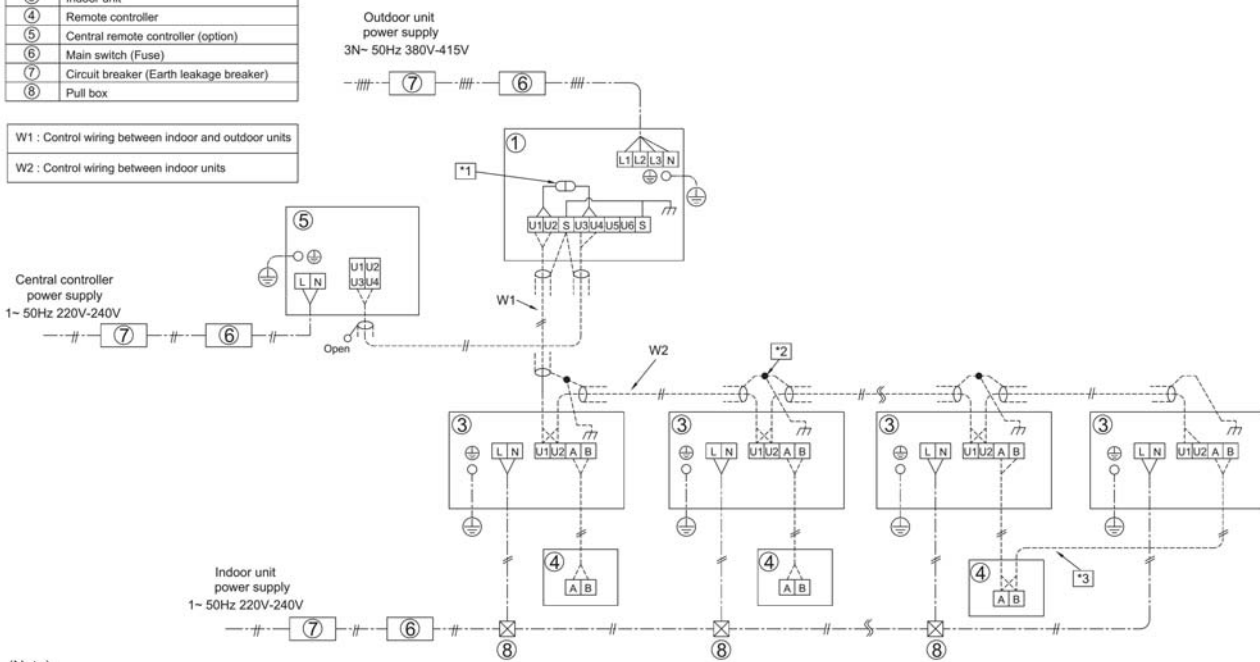

(Note)

- When perform a central control, connect the relay connector between [U1,U2] and [U3,U4] terminal of the header unit. (At shipment from factory : No connection)
- Connect the closed end terminal of shield wire.
(Connected to all connecting sections in each unit)
- Group control.
- Select the power supply wiring and fuse of outdoor/indoor units according to each model's specification.
Perform wiring of power supply complying with the rules and regulations of the local electric company.
- For the control wires connecting indoor units, outdoor units, and between indoor and outdoor units, use 2-core and non-polarity shield wires.
- As for details, see the wiring diagram of indoor/outdoor unit.
- Diagram of corrosion heavy protection model is the same as that of standard model.

Two units connected Model : MMY-AP***6HT8P

①	Outdoor unit (Header unit)
②	Outdoor unit (Follower unit)
③	Indoor unit
④	Remote controller
⑤	Central remote controller (option)
⑥	Main switch (Fuse)
⑦	Circuit breaker (Earth leakage breaker)
⑧	Pull box

W1 : Control wiring between indoor and outdoor units
W2 : Control wiring between indoor units
W3 : Control wiring between outdoor units

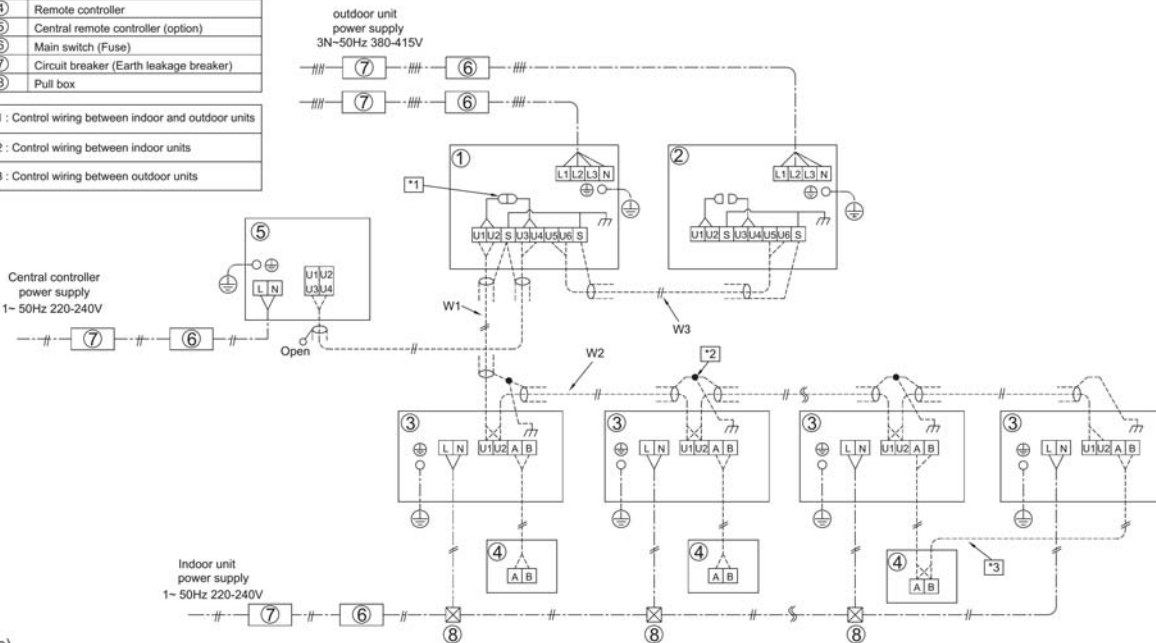

(Note)

1. When perform a central control, connect the relay connector between [U1,U2] and [U3,U4] terminal of the header unit. (At shipment from factory : No connection)
2. Connect the closed end terminal of shield wire.
(Connected to all connecting sections in each unit)
3. Group control.
4. Select the power supply wiring and fuse of outdoor/indoor units according to each model's specification.
Perform wiring of power supply complying with the rules and regulations of the local electric company.
5. For the control wires connecting indoor units, outdoor units, and between indoor and outdoor units,
use 2-core and non-polarity shield wires.
6. As for details, see the wiring diagram of indoor/outdoor unit.
7. Diagram of corrosion heavy protection model is the same as that of standard model.

Three units connected Model : MMY-AP***6HT8P

①	Outdoor unit (Header unit)
②	Outdoor unit (Follower unit)
③	Indoor unit
④	Remote controller
⑤	Central remote controller (option)
⑥	Main switch (Fuse)
⑦	Circuit breaker (Earth leakage breaker)
⑧	Pull box

W1 : Control wiring between indoor and outdoor units
W2 : Control wiring between indoor units
W3 : Control wiring between outdoor units

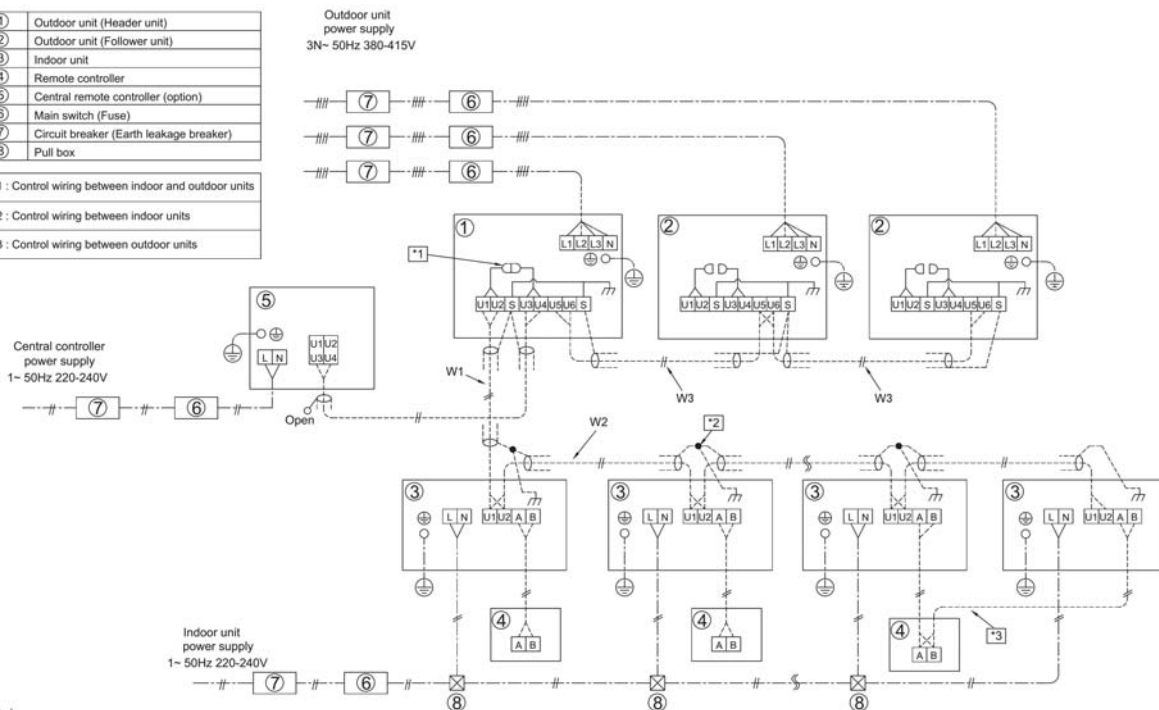

(Note)

- When perform a central control, connect the relay connector between [U1,U2] and [U3,U4] terminal of the header unit. (At shipment from factory : No connection)
- Connect the closed end terminal of shield wire.
(Connected to all connecting sections in each unit)
- Group control.
- Select the power supply wiring and fuse of outdoor/indoor units according to each model's specification.
Perform wiring of power supply complying with the rules and regulations of the local electric company.
- For the control wires connecting indoor units, outdoor units, and between indoor and outdoor units, use 2-core and non-polarity shield wires.
- As for details, see the wiring diagram of indoor/outdoor unit.
- Diagram of corrosion heavy protection model is the same as that of standard model.

Single unit connected

Model : MMY-AP***6HT7P

①	Outdoor unit (Header unit)
②	—
③	Indoor unit
④	Remote controller
⑤	Central remote controller (option)
⑥	Main switch (Fuse)
⑦	Circuit breaker (Earth leakage breaker)
⑧	Pull box

W1 : Control wiring between indoor and outdoor units
 W2 : Control wiring between indoor units

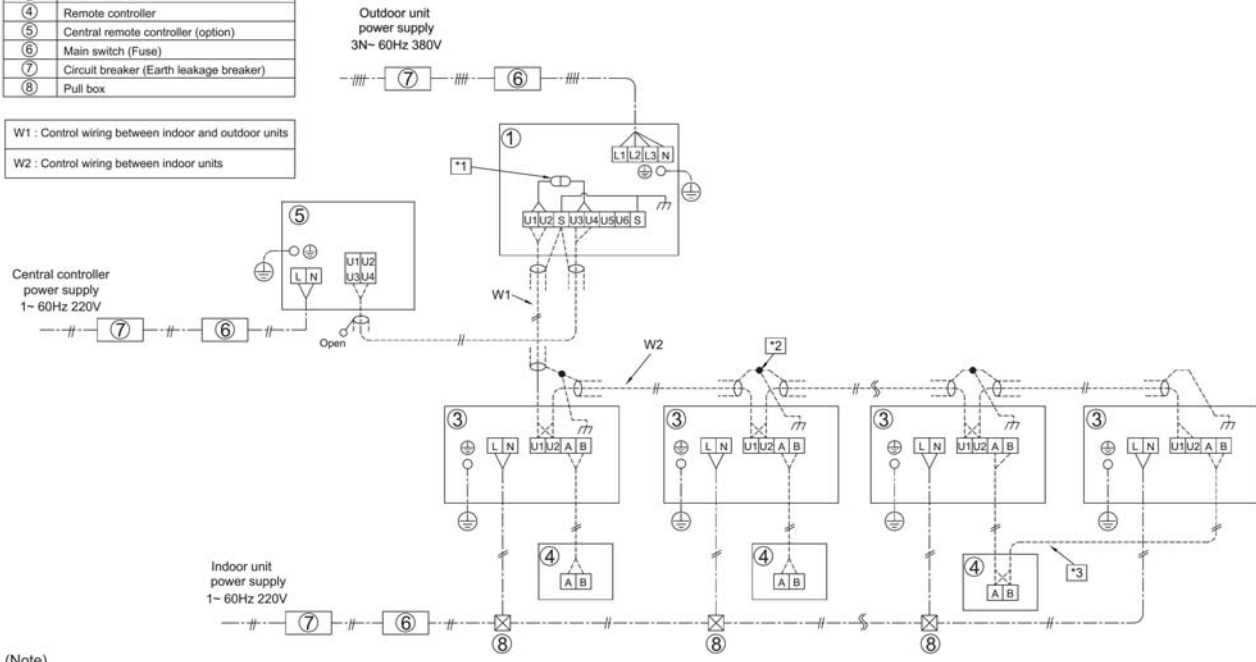

(Note)

- When perform a central control, connect the relay connector between [U1,U2] and [U3,U4] terminal of the header unit. (At shipment from factory : No connection)
- Connect the closed end terminal of shield wire. (Connected to all connecting sections in each unit)
- Group control.
- Select the power supply wiring and fuse of outdoor/indoor units according to each model's specification. Perform wiring of power supply complying with the rules and regulations of the local electric company.
- For the control wires connecting indoor units, outdoor units, and between indoor and outdoor units, use 2-core and non-polarity shield wires.
- As for details, see the wiring diagram of indoor/outdoor unit.
- Diagram of corrosion heavy protection model is the same as that of standard model.

Two units connected Model : MMY-AP***6HT7P

①	Outdoor unit (Header unit)
②	Outdoor unit (Follower unit)
③	Indoor unit
④	Remote controller
⑤	Central remote controller (option)
⑥	Main switch (Fuse)
⑦	Circuit breaker (Earth leakage breaker)
⑧	Pull box

W1 : Control wiring between indoor and outdoor units
W2 : Control wiring between indoor units
W3 : Control wiring between outdoor units

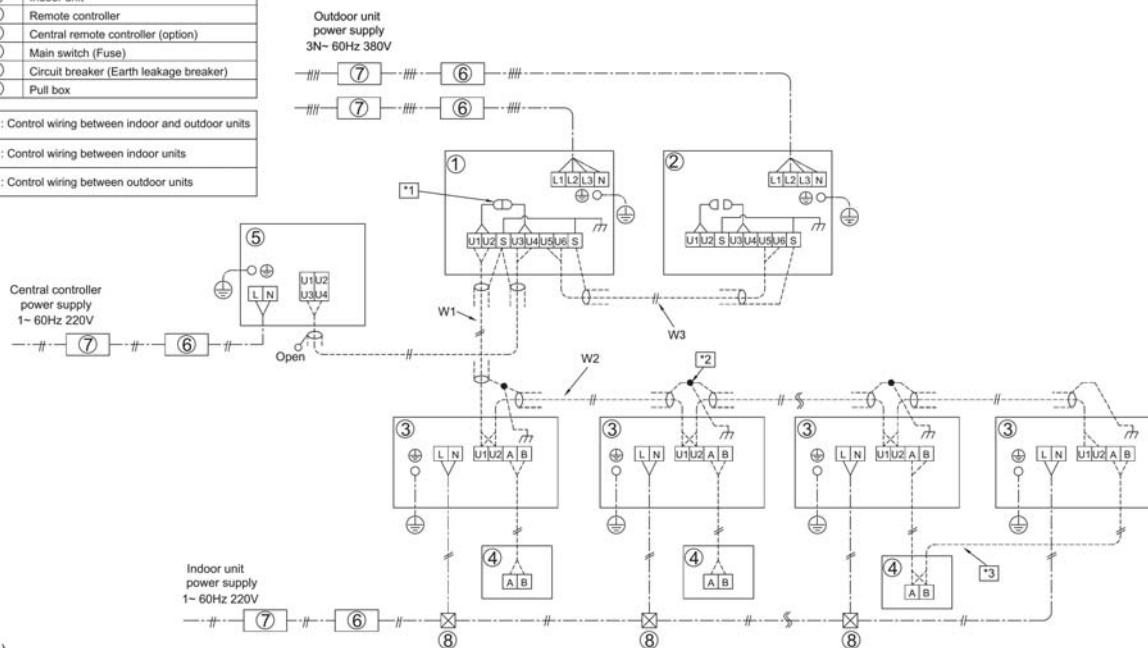

(Note)

1. When perform a central control, connect the relay connector between [U1,U2] and [U3,U4] terminal of the header unit. (At shipment from factory : No connection)
2. Connect the closed end terminal of shield wire.
(Connected to all connecting sections in each unit)
3. Group control.
4. Select the power supply wiring and fuse of outdoor/indoor units according to each model's specification.
Perform wiring of power supply complying with the rules and regulations of the local electric company.
5. For the control wires connecting indoor units, outdoor units, and between indoor and outdoor units, use 2-core and non-polarity shield wires.
6. As for details, see the wiring diagram of indoor/outdoor unit.
7. Diagram of corrosion heavy protection model is the same as that of standard model.

Three units connected Model : MMY-AP***6HT7P

①	Outdoor unit (Header unit)
②	Outdoor unit (Follower unit)
③	Indoor unit
④	Remote controller
⑤	Central remote controller (option)
⑥	Main switch (Fuse)
⑦	Circuit breaker (Earth leakage breaker)
⑧	Pull box

W1	: Control wiring between indoor and outdoor units
W2	: Control wiring between indoor units
W3	: Control wiring between outdoor units

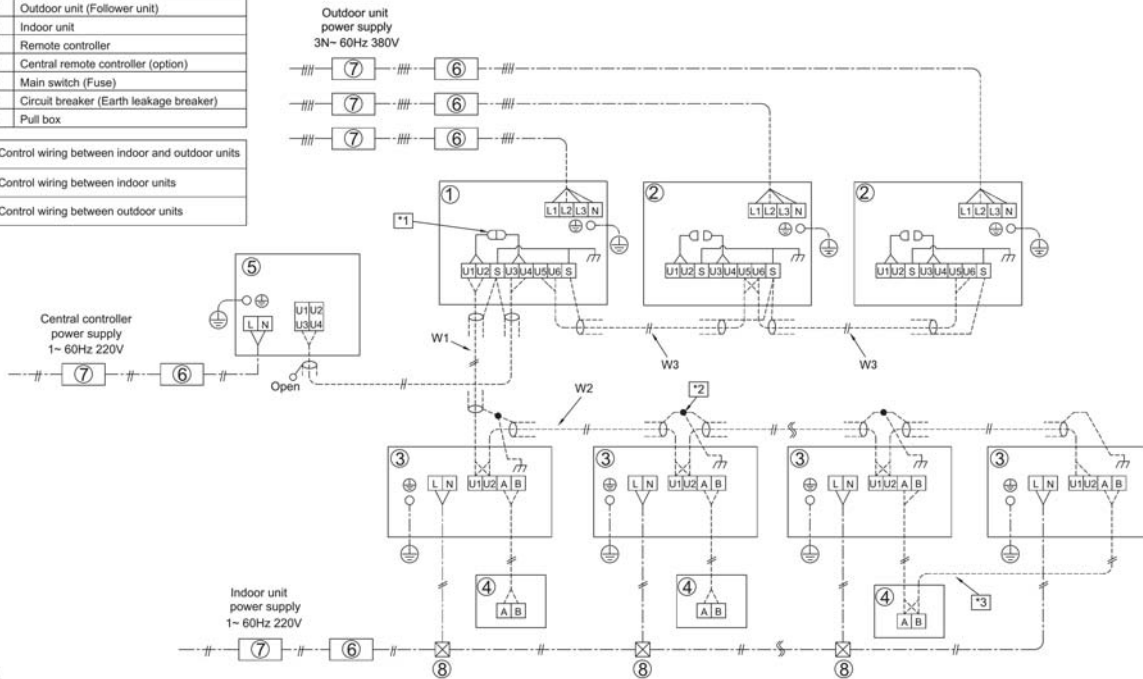

(Note)

1. When perform a central control, connect the relay connector between [U1,U2] and [U3,U4] terminal of the header unit. (At shipment from factory : No connection)
2. Connect the closed end terminal of shield wire.
(Connected to all connecting sections in each unit)
3. Group control.
4. Select the power supply wiring and fuse of outdoor/indoor units according to each model's specification.
Perform wiring of power supply complying with the rules and regulations of the local electric company.
5. For the control wires connecting indoor units, outdoor units, and between indoor and outdoor units, use 2-core and non-polarity shield wires.
6. As for details, see the wiring diagram of indoor/outdoor unit.
7. Diagram of corrosion heavy protection model is the same as that of standard model.



5-8. Applied control for Outdoor Unit

The outdoor fan high static pressure support and priority operation mode setting (cooling / heating / number of units / or priority indoor unit) functions are made available by setting relevant switches provided on the interface P.C. board of the outdoor unit.

5-8-1. Outdoor Fan High Static Pressure Shift

Purpose/characteristics

This function is used when connecting a duct to the discharge port of an outdoor unit (as part of, for example, unit installation on the floor by floor installation.)

Setup

Turn ON the DIP switch [SW10, Bit 2] provided on the interface P.C. board of the outdoor unit.

This function must be enabled with every discharge duct connected outdoor unit for both of the header and follower units.

Specification

Increase the speed of the propeller fan units on the outdoor fan to allow the installation of a duct with a maximum external static pressure not greater than specified in the table below. If a discharge duct with a resistance greater than 15 Pa (1.5 mmAq) is to be used, enable this function. The maximum external static pressures of base units are shown below (Table 1). In the case of combined use of multiple outdoor units, set all the units to the same maximum external static pressure as the one with the lowest maximum external static pressure (see Table 2).

Table 1: Maximum External Static Pressure of Base Outdoor Units

Model	MMY-	MAP0806*	MAP1006*	MAP1206*	MAP1406*	MAP1606*	MAP1806*	MAP2006*	MAP2206*
Maximum external static pressure	Pa	60	60	50	50	40	50	40	40
(*) Outdoor unit air flow	m3/h	9700	9700	12200	12200	12600	17300	17900	18500

(*) Calculate duct resistance from outdoor unit air flow.

Table 2: Maximum External Static Pressure for Combined Use of Base Units

Standard models

System	Combination			Maximum external static pressure
	HP	HP	Pa	
8	8			60
10	10			60
12	12			50
14	14			50
16	16			40
18	18			50
20	20			40
22	22			40
24	12	12		50
26	14	12		50
28	16	12		40
30	16	14		40
32	16	16		40
34	18	16		40
36	20	16		40
38	22	16		40
40	20	20		40
42	22	20		40
44	22	22		40
46	16	16	14	40
48	16	16	16	40
50	18	16	16	40
52	20	16	16	40
54	22	16	16	40
56	20	20	16	40
58	22	20	16	40
60	22	22	16	40

High efficiency models

System	Combination			Maximum external static pressure
	HP	HP	Pa	
20	10	10		60
22	12	10		50
36	12	12	12	50
38	14	12	12	50
40	14	14	12	50
42	14	14	14	50
44	16	14	14	40
54	20	20	14	40

5-8-2. Priority Operation Mode Setting

Purpose/characteristics

This function allows switching between priority cooling and priority heating.

Four patterns of priority operation mode setting are available as shown in the table below. Select a suitable priority mode according to the needs of the customer.

Setup

CAUTION

In the case of the priority indoor unit mode, it is necessary to set up the specific indoor unit chosen for priority operation (a single unit only).

(1) Outdoor unit setup method (header unit)

SW11		Operation
Bit 1	Bit 2	
OFF	OFF	Priority heating (factory default)
ON	OFF	Priority cooling
OFF	ON	Priority operation based on No. of units in operation (priority given to the operation mode with the largest share of units in operation)
ON	ON	Priority indoor unit (priority given to the operation mode of the specific indoor unit set up for priority operation)



(2) Indoor unit setup method for priority indoor unit mode

The setting can be changed only when the system is at rest. (Be sure to turn off the system prior to this operation.)

- 1 Push the **TEST** + **SET** + **CL** buttons simultaneously and hold for at least 4 seconds. The display window will start flashing in a little while.

Verify that the displayed CODE No. is 10.

- If the displayed CODE No. is not 10, press the **TEST** button to erase the display and repeat the procedure from the beginning.
(Note that the system does not respond to remote controller operation for about 1 minute after the **TEST** button is pushed.)
(In the case of group control, the indoor unit No. displayed first indicates the header unit.)

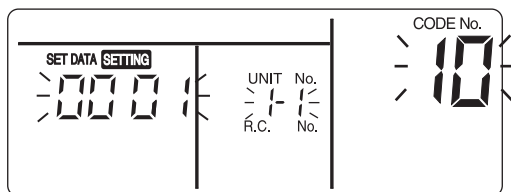
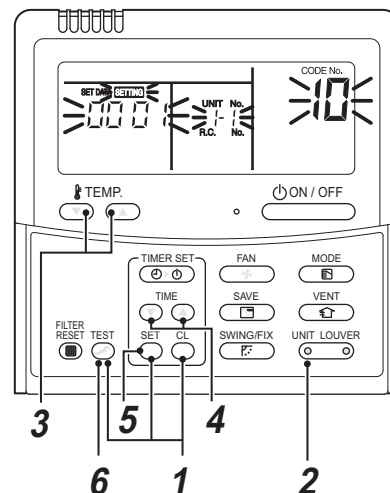

- 2 Each time the **UNIT LOUVER** button is pushed, one of the indoor unit Nos. under group control is displayed in turn. Select the indoor unit whose setting is to be changed.

The fan and flap of the selected indoor unit then come on, so that the position of this unit can be confirmed.

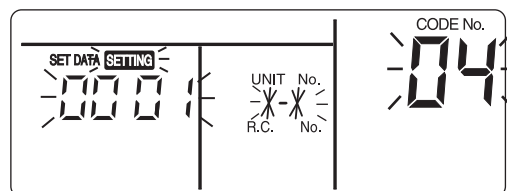

- 3 Use the **TEMP.** button to select the CODE No. 04.

- 4 Use the **TIME** button to select the SET DATA 0001.

Priority set 0001 No priority set 0000

- 5 Push the **SET** button.

The setup is finished when the display changes from flashing to steady.

- 6 Upon finishing the setup, push the **TEST** button. (This finalizes the setting.)

When the **TEST** button is pushed, the display goes blank, and the system returns to normal off state.

(Note that the system does not respond to remote controller operation for about 1 minute after the **TEST** button is pushed.)

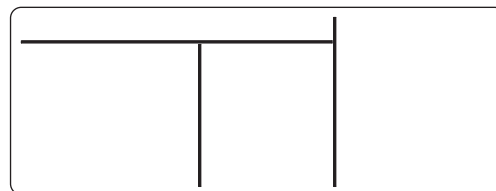



NOTE



Priority can be given to only one indoor unit. If more than one indoor unit is accidentally set to priority, an error code (L5 or L6: Duplicated indoor unit priority setting) will be displayed.



All units displaying L5 have been set to 0001 (priority). Keep the unit to which priority should be given as it is, and change the value back to 0000 (no priority) for all the rest.

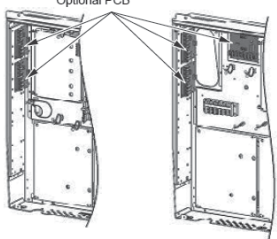
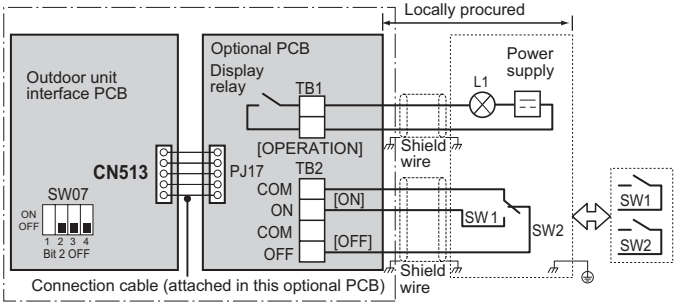

Error code	Description
L5	Duplicated indoor unit priority setting (The unit is set to 0001.)
L6	Duplicated indoor unit priority setting (The unit is set to 0000.)

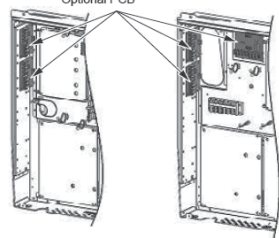
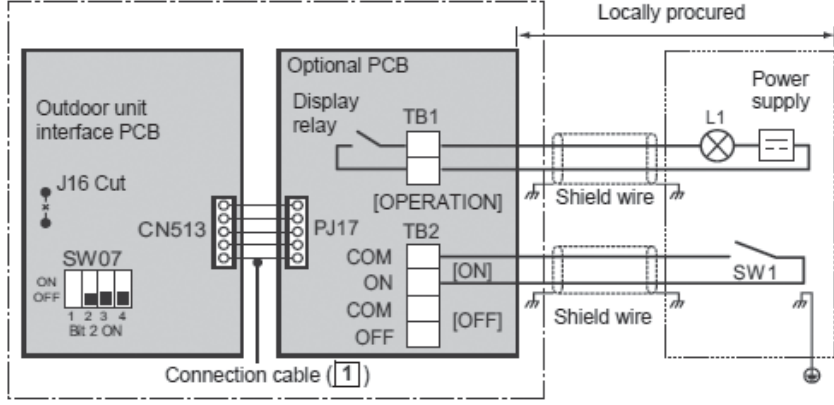
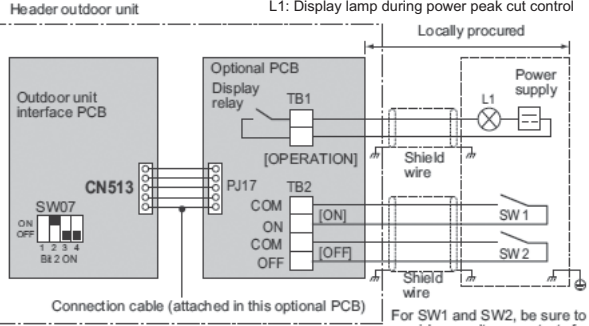

5-9. Optional printed circuit board (PCB) of outdoor unit

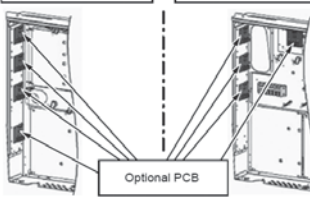

Model name	Appearance	Function																		
TCB-PCDM4E	 <p>Size: 71 x 85 (mm)</p>	<p>[1] Power peak-cut Control</p> <ul style="list-style-type: none"> • Purpose: Limiting air conditioning performance with external signals and decreasing the peak power consumption. • Feature The upper limit capacity of the outdoor unit is restricted based on the outdoor power peak selected setting. <p>Standard Specifications (Wiring example)</p>																		
	<p>Application</p>  <p>MMY-MAP080 to 120 MMY-MAP140 to 220</p>  <p>(max. number installed: 1 pc)</p> <p>* Install the optional PCB in the outdoor header unit.</p>	 <p>Header outdoor unit L1: Display lamp during power peak cut control</p> <p>Locally procured</p> <p>Outdoor unit interface PCB Optional PCB</p> <p>Display relay TB1</p> <p>[OPERATION] TB2</p> <p>COM [ON]</p> <p>ON [OFF]</p> <p>COM [OFF]</p> <p>OFF</p> <p>Shield wire</p> <p>Power supply</p> <p>L1</p> <p>Shield wire</p> <p>SW1</p> <p>SW2</p> <p>SW1</p> <p>SW2</p> <p>Shield wire</p> <p>Connection cable (attached in this optional PCB)</p> <p>For SW1 and SW2, be sure to provide no-voltage contacts for each terminal. The input signals of SW1 and SW2 may be pulse input (100 msec or more) or continuous make. Do not turn on [SW1] and [SW2] simultaneously.</p> <p><SW07 (bit 2) OFF [2-stage switching]></p> <table border="1" data-bbox="545 1160 1474 1370"> <thead> <tr> <th colspan="2">Input</th> <th colspan="2">SW07 (bit 1)</th> <th rowspan="2">Display relay (L1)</th> </tr> <tr> <th>SW1</th> <th>SW2</th> <th>Bit 1 OFF</th> <th>Bit 1 ON</th> </tr> </thead> <tbody> <tr> <td>OFF</td> <td>ON</td> <td>100 % (normal operation)</td> <td>100 % (normal operation)</td> <td>OFF</td> </tr> <tr> <td>ON</td> <td>OFF</td> <td>0 % (forced stop)</td> <td>Approx. 60 % (upper limit regulated)</td> <td>ON</td> </tr> </tbody> </table>	Input		SW07 (bit 1)		Display relay (L1)	SW1	SW2	Bit 1 OFF	Bit 1 ON	OFF	ON	100 % (normal operation)	100 % (normal operation)	OFF	ON	OFF	0 % (forced stop)	Approx. 60 % (upper limit regulated)
Input		SW07 (bit 1)		Display relay (L1)																
SW1	SW2	Bit 1 OFF	Bit 1 ON																	
OFF	ON	100 % (normal operation)	100 % (normal operation)	OFF																
ON	OFF	0 % (forced stop)	Approx. 60 % (upper limit regulated)	ON																

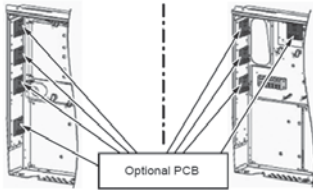
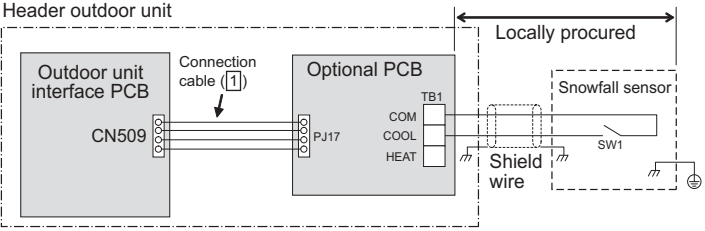

Model name	Appearance	Function																																												
<p style="writing-mode: vertical-rl; transform: rotate(180deg);">TCB-PCMO4E</p>	 <p>Size: 55.5 x 60 (mm)</p>	<p>For one input function</p> <p>Power peak-cut ON-OFF control is made possible on the SMMS-e on only the [ON] terminal input (SW1) by cutting the jumper lead (J16) of the center outdoor unit interface PCB. (Wiring example)</p>																																												
	<p>Application</p>  <p>MMY-MAP080 to 120 MMY-MAP140 to 220</p> <p>Optional PCB</p>  <p>(max. number installed: 1 pc)</p> <p>* Install the optional PCB in the outdoor header unit.</p>	<p>Header outdoor unit L1: Display lamp during power peak cut control</p>  <p><SW07 (bit 2) OFF [2-stage switching]></p> <p>Power peak-cut control turns ON when SW1 in the wiring example is ON (continuous make).</p> <table border="1" data-bbox="550 1075 1460 1243"> <thead> <tr> <th rowspan="2">Jumper lead J16</th> <th rowspan="2">Input SW1</th> <th colspan="2">SW07 (bit 1)</th> <th rowspan="2">Display relay (L1)</th> </tr> <tr> <th>Bit 1 OFF</th> <th>Bit 1 ON</th> </tr> </thead> <tbody> <tr> <td rowspan="2">Cut</td> <td>OFF</td> <td>100% (normal operation)</td> <td>100% (normal operation)</td> <td>OFF</td> </tr> <tr> <td>ON</td> <td>0% (forced stop)</td> <td>Approx. 60% (upper limit regulated)</td> <td>ON</td> </tr> </tbody> </table> <p>Enhanced Specifications (Wiring example)</p>  <p><SW07 (bit 2) ON [4-stage switching]></p> <table border="1" data-bbox="550 1758 1372 2049"> <thead> <tr> <th colspan="2">Input</th> <th colspan="2">SW07 (bit 1)</th> <th rowspan="2">Display relay (L1)</th> </tr> <tr> <th>SW1</th> <th>SW2</th> <th>Bit 1 OFF</th> <th>Bit 1 ON</th> </tr> </thead> <tbody> <tr> <td>OFF</td> <td>OFF</td> <td>100% (normal operation)</td> <td>100% (normal operation)</td> <td>OFF</td> </tr> <tr> <td>ON</td> <td>OFF</td> <td>Approx. 80% (upper limit regulated)</td> <td>Approx. 85% (upper limit regulated)</td> <td>ON</td> </tr> <tr> <td>OFF</td> <td>ON</td> <td>Approx. 60% (upper limit regulated)</td> <td>Approx. 75% (upper limit regulated)</td> <td>ON</td> </tr> <tr> <td>ON</td> <td>ON</td> <td>0% (forced stop)</td> <td>Approx. 60% (upper limit regulated)</td> <td>ON</td> </tr> </tbody> </table> <p>For SW1 and SW2, be sure to provide no-voltage contacts for each terminal.</p>	Jumper lead J16	Input SW1	SW07 (bit 1)		Display relay (L1)	Bit 1 OFF	Bit 1 ON	Cut	OFF	100% (normal operation)	100% (normal operation)	OFF	ON	0% (forced stop)	Approx. 60% (upper limit regulated)	ON	Input		SW07 (bit 1)		Display relay (L1)	SW1	SW2	Bit 1 OFF	Bit 1 ON	OFF	OFF	100% (normal operation)	100% (normal operation)	OFF	ON	OFF	Approx. 80% (upper limit regulated)	Approx. 85% (upper limit regulated)	ON	OFF	ON	Approx. 60% (upper limit regulated)	Approx. 75% (upper limit regulated)	ON	ON	ON	0% (forced stop)	Approx. 60% (upper limit regulated)
Jumper lead J16	Input SW1	SW07 (bit 1)			Display relay (L1)																																									
		Bit 1 OFF	Bit 1 ON																																											
Cut	OFF	100% (normal operation)	100% (normal operation)	OFF																																										
	ON	0% (forced stop)	Approx. 60% (upper limit regulated)	ON																																										
Input		SW07 (bit 1)		Display relay (L1)																																										
SW1	SW2	Bit 1 OFF	Bit 1 ON																																											
OFF	OFF	100% (normal operation)	100% (normal operation)	OFF																																										
ON	OFF	Approx. 80% (upper limit regulated)	Approx. 85% (upper limit regulated)	ON																																										
OFF	ON	Approx. 60% (upper limit regulated)	Approx. 75% (upper limit regulated)	ON																																										
ON	ON	0% (forced stop)	Approx. 60% (upper limit regulated)	ON																																										

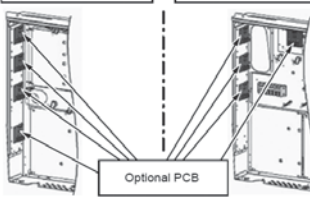
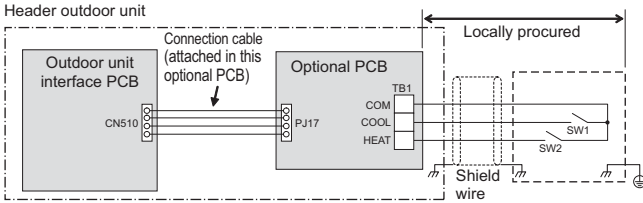

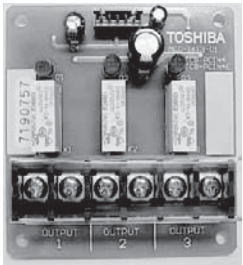
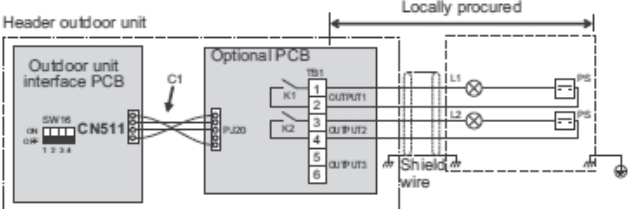
Model name	Appearance	Function																
TCB-PCMO4E	 <p>Size: 55.5 x 60 (mm)</p>	<p>[2] External master ON/OFF control</p> <ul style="list-style-type: none"> • Feature The outdoor unit starts or stop the system. • Function By connecting the cable (attached in this optional PCB) to the interface PC board on an outdoor unit, all indoor units connected to the outdoor unit enable to operate simultaneously. • Operation The outdoor unit connection is for the header unit (U1). 																
	<p>Application</p>  <p>MMY-MAP080 to 120 MMY-MAP140 to 220</p>  <p>(max. number installed: 4 pcs)</p> <p>* Install the optional PCB in the outdoor header unit.</p>	<div data-bbox="550 627 1149 817"> <p>Header outdoor unit</p> <p>SW1: Operation input switch SW2: Stop input switch</p> </div> <table border="1" data-bbox="550 891 1468 1064"> <thead> <tr> <th>Terminal</th> <th>Input signal</th> <th>Operation</th> </tr> </thead> <tbody> <tr> <td>COOL (SW1)</td> <td>ON OFF</td> <td>All indoor units operate together</td> </tr> <tr> <td>HEAT (SW2)</td> <td>ON OFF</td> <td>All indoor units stop together</td> </tr> </tbody> </table> <p>Provide no-voltage pulse contacts for each terminal. Hold the ON state for at least 100 msec. Do not turn SW1 and SW2 ON simultaneously</p> <p>[3] Night time operation (sound reduction) control</p> <ul style="list-style-type: none"> • Purpose: Reducing noise from an outdoor unit • Feature Sound level can be reduced by restricting the compressor and fan speed • Function As the cable (attached in this optional PCB) is connected to the "Interface PCB" on an outdoor unit, both compressor speed and fan speed are restricted while the signal of the night operation control is input. It makes the noise reduction during the night time operation. • Operation The outdoor unit connection is for the header unit (U1). <div data-bbox="550 1556 1133 1747"> <p>Header outdoor unit</p> <p>SW1: Night time signal switch</p> </div> <table border="1" data-bbox="550 1792 1468 1960"> <thead> <tr> <th>Terminal</th> <th>Input signal</th> <th>Operation</th> </tr> </thead> <tbody> <tr> <td rowspan="2">COOL (SW1)</td> <td>ON OFF</td> <td>All indoor units operate together</td> </tr> <tr> <td>ON OFF</td> <td>All indoor units stop together</td> </tr> </tbody> </table> <p>Each terminal should be connected to dry contact. The input signal is recognized during its rising/falling phase. (After reaching the top/bottom of the rising/falling edge, the signal must remain there for at least 100 ms.)</p>	Terminal	Input signal	Operation	COOL (SW1)	ON OFF	All indoor units operate together	HEAT (SW2)	ON OFF	All indoor units stop together	Terminal	Input signal	Operation	COOL (SW1)	ON OFF	All indoor units operate together	ON OFF
Terminal	Input signal	Operation																
COOL (SW1)	ON OFF	All indoor units operate together																
HEAT (SW2)	ON OFF	All indoor units stop together																
Terminal	Input signal	Operation																
COOL (SW1)	ON OFF	All indoor units operate together																
	ON OFF	All indoor units stop together																

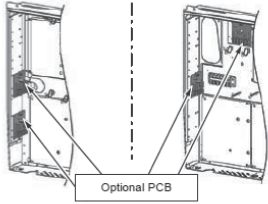
Model name	Appearance	Function																																						
TCB-PCMO4E	 <p>Size: 55.5 x 60 (mm)</p>	<p>Sound reduction and approximation capacity (reference)</p> <table border="1" data-bbox="560 353 1458 674"> <thead> <tr> <th rowspan="2"></th> <th rowspan="2">Night operation sound reduction dB (A)</th> <th colspan="2">Capacity</th> </tr> <tr> <th>COOL</th> <th>HEAT</th> </tr> </thead> <tbody> <tr> <td>0806 type</td> <td>50</td> <td>Approx. 85%</td> <td>Approx. 80%</td> </tr> <tr> <td>1006 type</td> <td>50</td> <td>Approx. 70%</td> <td>Approx. 65%</td> </tr> <tr> <td>1206 type</td> <td>50</td> <td>Approx. 60%</td> <td>Approx. 55%</td> </tr> <tr> <td>1406 type</td> <td>53</td> <td>Approx. 80%</td> <td>Approx. 80%</td> </tr> <tr> <td>1606 type</td> <td>53</td> <td>Approx. 70%</td> <td>Approx. 70%</td> </tr> <tr> <td>1806 type</td> <td>54</td> <td>Approx. 65%</td> <td>Approx. 65%</td> </tr> <tr> <td>2006 type</td> <td>54</td> <td>Approx. 60%</td> <td>Approx. 60%</td> </tr> <tr> <td>2206 type</td> <td>54</td> <td>Approx. 55%</td> <td>Approx. 55%</td> </tr> </tbody> </table>		Night operation sound reduction dB (A)	Capacity		COOL	HEAT	0806 type	50	Approx. 85%	Approx. 80%	1006 type	50	Approx. 70%	Approx. 65%	1206 type	50	Approx. 60%	Approx. 55%	1406 type	53	Approx. 80%	Approx. 80%	1606 type	53	Approx. 70%	Approx. 70%	1806 type	54	Approx. 65%	Approx. 65%	2006 type	54	Approx. 60%	Approx. 60%	2206 type	54	Approx. 55%	Approx. 55%
		Night operation sound reduction dB (A)			Capacity																																			
			COOL	HEAT																																				
	0806 type	50	Approx. 85%	Approx. 80%																																				
1006 type	50	Approx. 70%	Approx. 65%																																					
1206 type	50	Approx. 60%	Approx. 55%																																					
1406 type	53	Approx. 80%	Approx. 80%																																					
1606 type	53	Approx. 70%	Approx. 70%																																					
1806 type	54	Approx. 65%	Approx. 65%																																					
2006 type	54	Approx. 60%	Approx. 60%																																					
2206 type	54	Approx. 55%	Approx. 55%																																					
<p>Application</p>	<p>Condition Cooling: (Indoor 27 deg DB, 19 deg WB) (Outdoor temperature 25 deg DB) Heating: (Indoor 20 deg DB) (Outdoor temperature 7 deg DB, 6 deg WB)</p>																																							
	<p>[4] Snowfall fan control</p> <ul style="list-style-type: none"> • Purpose: Rotating the fan to prevent snow accumulation • Feature <p>Outdoor fan is operated from the snowfall signal received from the outside.</p>																																							
<p>MMY-MAP080,120 MMY-MAP140,220</p>  <p>(max. number installed: 4 pcs)</p> <p>* Install the optional PCB in the outdoor header unit.</p>	<p>▼ Functions The outdoor unit fan operates at snowfall by connecting to the outdoor unit interface PCB.</p> <p>▼ Operation</p>  <p>SW1: Snowfall selection switch (snowfall sensor)</p> <table border="1" data-bbox="545 1415 1465 1585"> <thead> <tr> <th>Terminal</th> <th>Input signal</th> <th>Operation</th> </tr> </thead> <tbody> <tr> <td rowspan="2">Cooling (SW1)</td> <td>ON OFF</td> <td>Snowfall fan control (Fan in outdoor unit operates.)</td> </tr> <tr> <td>ON OFF</td> <td>Normal operation</td> </tr> </tbody> </table> <p>Be sure to provide no-voltage continuous contacts for each terminal.</p>	Terminal	Input signal	Operation	Cooling (SW1)	ON OFF	Snowfall fan control (Fan in outdoor unit operates.)	ON OFF	Normal operation																															
Terminal	Input signal	Operation																																						
Cooling (SW1)	ON OFF	Snowfall fan control (Fan in outdoor unit operates.)																																						
	ON OFF	Normal operation																																						

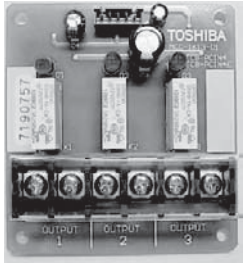
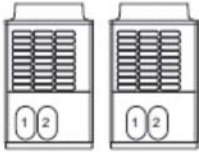
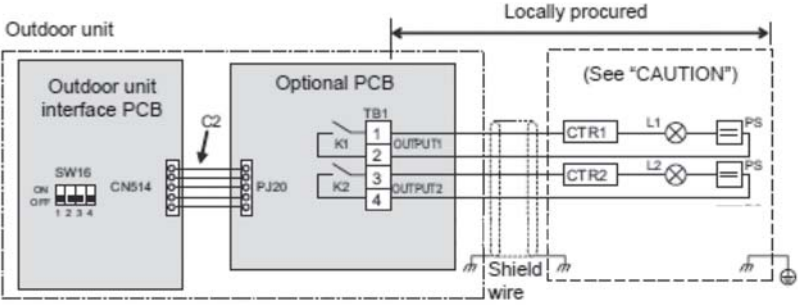
Model name	Appearance	Function																																																							
TCB-PCIN4E	 <p>Size: 55.5 x 60 (mm)</p>	<p>[5] Operation mode selection control</p> <ul style="list-style-type: none"> • Purpose: Limiting operation modes to cooling and heating only • Feature This control can restrict the selectable operation mode. <p>▼ Functions The heating/cooling mode of the system can be selected by connecting to the interface PCB of outdoor units.</p> <p>▼ Operation The outdoor unit connection is for the header unit (U1).</p>																																																							
	<p>Application</p>  <p>MMY-MAP080 to 120 MMY-MAP140 to 220</p>  <p>(max. number installed: 4 pcs)</p> <p>* Install the optional PCB in the outdoor header unit.</p>	 <p>SW1: Cooling mode specified input switch SW2: Heating mode specified input switch</p> <table border="1" data-bbox="558 896 1189 1019"> <thead> <tr> <th colspan="2">Input Signal</th> <th rowspan="2">Operation: Selected operation mode</th> </tr> <tr> <th>Cooling (SW1)</th> <th>Heating (SW2)</th> </tr> </thead> <tbody> <tr> <td>ON</td> <td>OFF</td> <td>Cooling operation only</td> </tr> <tr> <td>OFF</td> <td>ON</td> <td>Heating operation only</td> </tr> <tr> <td>OFF</td> <td>OFF</td> <td>Normal operation</td> </tr> </tbody> </table> <p>Each terminal should be connected to dry contact.</p> <p>About Switching of Processing of Indoor Unit Operation State</p> <p>Processing of the operation state can be switched for indoor units in a mode other than the selected operation mode by setting the jumper lead (J01) of the header outdoor unit interface PCB.</p> <table border="1" data-bbox="558 1265 1276 1803"> <thead> <tr> <th>Jumper lead</th> <th colspan="3">Details of Processing</th> </tr> </thead> <tbody> <tr> <td rowspan="4">J01 connected (factory default)</td> <td colspan="3">Unallowed indoor units in a mode other than the selected operation mode are not treated as priority (thermo OFF state). (Unallowed indoor units)</td> </tr> <tr> <td>Operation Mode</td> <td>Operation State</td> <td rowspan="3">Remote control indicator is displayed.</td> </tr> <tr> <td>Cooling unit</td> <td>Air blow operation at blow rate set on remote control</td> </tr> <tr> <td>Heating unit</td> <td>Air blow operation at super-slow blow rate</td> </tr> <tr> <td>Air blow unit</td> <td>Regular air blow operation at blow rate set on remote control</td> <td></td> </tr> <tr> <td rowspan="4">J01 cut</td> <td colspan="3">Indoor units in a mode other than the selected operation mode are forcibly switched to the selected operation mode.</td> </tr> <tr> <td>PC board selection mode</td> <td colspan="2">Remote control operation/display</td> </tr> <tr> <td>Normal</td> <td>*, Δ, ✱, or ✶ can be selected</td> <td rowspan="3">When using the remote control, (mode select control) indicator is displayed.</td> </tr> <tr> <td>Cool</td> <td>Only *, Δ, or ✶ can be selected</td> </tr> <tr> <td>Heat</td> <td>Only ✱ or ✶ can be selected</td> </tr> </tbody> </table> <p>The jumper lead is not switched. Indoor units in a mode other than the selected operation mode are forcibly switched to the selected operation mode.</p> <table border="1" data-bbox="558 1971 1260 2116"> <thead> <tr> <th>PC board selection mode</th> <th colspan="2">Remote control operation/display</th> </tr> </thead> <tbody> <tr> <td>Normal</td> <td>*, Δ, ✱, or ✶ can be selected</td> <td rowspan="3">When using the remote control, (mode select control) indicator is displayed.</td> </tr> <tr> <td>Cool</td> <td>Only *, Δ, or ✶ can be selected</td> </tr> <tr> <td>Heat</td> <td>Only ✱ or ✶ can be selected</td> </tr> </tbody> </table>	Input Signal		Operation: Selected operation mode	Cooling (SW1)	Heating (SW2)	ON	OFF	Cooling operation only	OFF	ON	Heating operation only	OFF	OFF	Normal operation	Jumper lead	Details of Processing			J01 connected (factory default)	Unallowed indoor units in a mode other than the selected operation mode are not treated as priority (thermo OFF state). (Unallowed indoor units)			Operation Mode	Operation State	Remote control indicator is displayed.	Cooling unit	Air blow operation at blow rate set on remote control	Heating unit	Air blow operation at super-slow blow rate	Air blow unit	Regular air blow operation at blow rate set on remote control		J01 cut	Indoor units in a mode other than the selected operation mode are forcibly switched to the selected operation mode.			PC board selection mode	Remote control operation/display		Normal	*, Δ, ✱, or ✶ can be selected	When using the remote control, (mode select control) indicator is displayed.	Cool	Only *, Δ, or ✶ can be selected	Heat	Only ✱ or ✶ can be selected	PC board selection mode	Remote control operation/display		Normal	*, Δ, ✱, or ✶ can be selected	When using the remote control, (mode select control) indicator is displayed.	Cool	Only *, Δ, or ✶ can be selected	Heat
Input Signal		Operation: Selected operation mode																																																							
Cooling (SW1)	Heating (SW2)																																																								
ON	OFF	Cooling operation only																																																							
OFF	ON	Heating operation only																																																							
OFF	OFF	Normal operation																																																							
Jumper lead	Details of Processing																																																								
J01 connected (factory default)	Unallowed indoor units in a mode other than the selected operation mode are not treated as priority (thermo OFF state). (Unallowed indoor units)																																																								
	Operation Mode	Operation State	Remote control indicator is displayed.																																																						
	Cooling unit	Air blow operation at blow rate set on remote control																																																							
	Heating unit	Air blow operation at super-slow blow rate																																																							
Air blow unit	Regular air blow operation at blow rate set on remote control																																																								
J01 cut	Indoor units in a mode other than the selected operation mode are forcibly switched to the selected operation mode.																																																								
	PC board selection mode	Remote control operation/display																																																							
	Normal	*, Δ, ✱, or ✶ can be selected	When using the remote control, (mode select control) indicator is displayed.																																																						
	Cool	Only *, Δ, or ✶ can be selected																																																							
Heat	Only ✱ or ✶ can be selected																																																								
PC board selection mode	Remote control operation/display																																																								
Normal	*, Δ, ✱, or ✶ can be selected	When using the remote control, (mode select control) indicator is displayed.																																																							
Cool	Only *, Δ, or ✶ can be selected																																																								
Heat	Only ✱ or ✶ can be selected																																																								

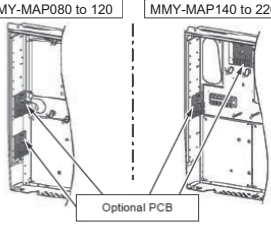
Model name	Appearance	Function																			
TCB-PCIN4E	 <p>Size: 73 x 79 (mm)</p>	<p>[6] Error / Operation Output</p> <ul style="list-style-type: none"> • Feature Operation and error monitoring is possible. ▼ Function The operation error output PCB can indicate operation and error states by connecting to the interface PCB of outdoor units. ▼ Operation Operation output: The operation indicator is on while any indoor unit in the system is operating. Error output: The error indicator is on when an error is occurred on even one of the indoor or outdoor units in the system. <p>Wiring example</p> 																			
	<p>Application</p>  <p>MMY-MAP080 to 120 MMY-MAP140 to 220</p>  <p>Optional PCB</p> <p>(max. number installed: 2 pcs)</p> <p>* Install the optional PCB in the outdoor header unit.</p>	<table border="1"> <tr> <td>C1</td> <td>Attached connection cable 1 (4wires)</td> </tr> <tr> <td>CN511</td> <td>Connector on interface side (green)</td> </tr> <tr> <td>K1, K2</td> <td>Relays</td> </tr> <tr> <td>L1</td> <td>Error indication Lamp</td> </tr> <tr> <td>L2</td> <td>Operation indication Lamp</td> </tr> <tr> <td>OUTPUT1</td> <td>Error output</td> </tr> <tr> <td>OUTPUT2</td> <td>Operation output</td> </tr> <tr> <td>PJ20</td> <td>Connector on optional PCB side</td> </tr> <tr> <td>PS</td> <td>Power supply unit</td> </tr> <tr> <td>TB1</td> <td>Terminal block</td> </tr> </table> <p>* [OUTPUT3] is normally output when power is turned out.</p>	C1	Attached connection cable 1 (4wires)	CN511	Connector on interface side (green)	K1, K2	Relays	L1	Error indication Lamp	L2	Operation indication Lamp	OUTPUT1	Error output	OUTPUT2	Operation output	PJ20	Connector on optional PCB side	PS	Power supply unit	TB1
C1	Attached connection cable 1 (4wires)																				
CN511	Connector on interface side (green)																				
K1, K2	Relays																				
L1	Error indication Lamp																				
L2	Operation indication Lamp																				
OUTPUT1	Error output																				
OUTPUT2	Operation output																				
PJ20	Connector on optional PCB side																				
PS	Power supply unit																				
TB1	Terminal block																				

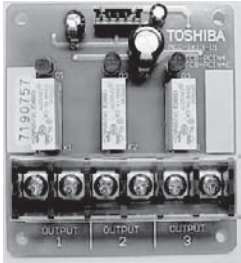
Model name	Appearance	Function																					
TCB-PCIN4E	 <p>Size: 73 x 79 (mm)</p>	<p>[7] Compressor Operation Output</p> <ul style="list-style-type: none"> • Feature Outputs the operation status of the compressors in each outdoor unit. <p>▼ Functions This function can be applied, for example, to the elapsed operation time count of each compressor mounted on an outdoor unit since the compressor in operation signal can be output externally</p> <p>▼ Operation During compressor operation, the relay of the output terminal corresponding to that compressor turns ON (closes) and turns OFF (opens) when compressor operation stops. As shown in the figure, the output terminals are "OUTPUT1", "OUTPUT2" from the left compressor facing the front of the outdoor unit.</p>  <p>Wiring example</p> 																					
	Application																						
	 <p>MMY-MAP080 to 120 MMY-MAP140 to 220</p>  <p style="text-align: center;">Optional PCB (max. number installed: 2 pcs)</p> <p>* Install the optional PCB in individual outdoor unit</p>	<table border="1"> <tbody> <tr> <td>C2</td> <td>Connector cable 2 (2)</td> </tr> <tr> <td>CN514</td> <td>Connector on interface side (green)</td> </tr> <tr> <td>CTR1</td> <td>Elapsed operation counter 1</td> </tr> <tr> <td>CTR2</td> <td>Elapsed operation counter 2</td> </tr> <tr> <td>K1, K2</td> <td>Relays</td> </tr> <tr> <td>L1, L2</td> <td>Operation indication LEDs</td> </tr> <tr> <td>OUTPUT1</td> <td>Compressor 1 operation output terminal</td> </tr> <tr> <td>OUTPUT2</td> <td>Compressor 2 operation output terminal</td> </tr> <tr> <td>PJ20</td> <td>Connector on optional PCB side</td> </tr> <tr> <td>PS</td> <td>Power supply unit</td> </tr> <tr> <td>TB1</td> <td>Terminal block</td> </tr> </tbody> </table>	C2	Connector cable 2 (2)	CN514	Connector on interface side (green)	CTR1	Elapsed operation counter 1	CTR2	Elapsed operation counter 2	K1, K2	Relays	L1, L2	Operation indication LEDs	OUTPUT1	Compressor 1 operation output terminal	OUTPUT2	Compressor 2 operation output terminal	PJ20	Connector on optional PCB side	PS	Power supply unit	TB1
C2	Connector cable 2 (2)																						
CN514	Connector on interface side (green)																						
CTR1	Elapsed operation counter 1																						
CTR2	Elapsed operation counter 2																						
K1, K2	Relays																						
L1, L2	Operation indication LEDs																						
OUTPUT1	Compressor 1 operation output terminal																						
OUTPUT2	Compressor 2 operation output terminal																						
PJ20	Connector on optional PCB side																						
PS	Power supply unit																						
TB1	Terminal block																						

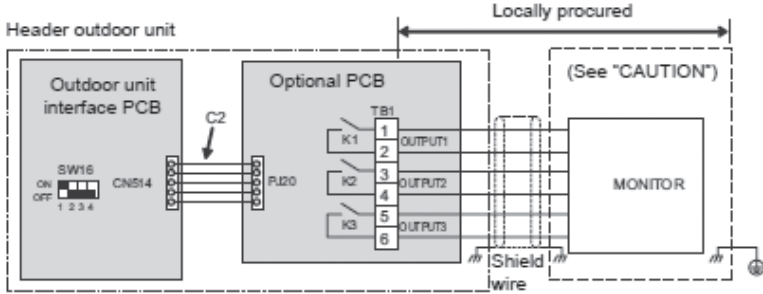
Model name	Appearance	Function																																															
TCB-PCIN4E	 <p>Size: 73 x 79 (mm)</p>	<p>[8] Operating Rate Output</p> <ul style="list-style-type: none"> • Feature Relay turn ON/OFF depending on the running rate of the system. <p>▼ Functions The operation state can be remotely checked since the system operating rate signal can be output externally.</p> <p>▼ Operation As shown in the table, each of the output terminals turns ON (relay closes) and OFF (relay opens) according to the system operating rate.</p> <table border="1" data-bbox="564 607 1430 864"> <thead> <tr> <th>Functions</th> <th>SW16</th> <th>OUTPUT1</th> <th>OUTPUT2</th> <th>OUTPUT3</th> <th>Operating rate FA</th> </tr> </thead> <tbody> <tr> <td rowspan="8">System operating rate output</td> <td>ON</td> <td>OFF</td> <td>OFF</td> <td>OFF</td> <td>FA=0%</td> </tr> <tr> <td>OFF</td> <td>ON</td> <td>OFF</td> <td>OFF</td> <td>0%<FA<20%</td> </tr> <tr> <td></td> <td>OFF</td> <td>ON</td> <td>OFF</td> <td>20%≤FA<35%</td> </tr> <tr> <td></td> <td>ON</td> <td>ON</td> <td>OFF</td> <td>35%≤FA<50%</td> </tr> <tr> <td></td> <td>OFF</td> <td>OFF</td> <td>ON</td> <td>50%≤FA<65%</td> </tr> <tr> <td></td> <td>ON</td> <td>OFF</td> <td>ON</td> <td>65%≤FA<80%</td> </tr> <tr> <td></td> <td>OFF</td> <td>ON</td> <td>ON</td> <td>80%≤FA<95%</td> </tr> <tr> <td></td> <td>ON</td> <td>ON</td> <td>ON</td> <td>95%≤FA</td> </tr> </tbody> </table> <p style="text-align: right;">OFF=relay open ON=relay closed</p>	Functions	SW16	OUTPUT1	OUTPUT2	OUTPUT3	Operating rate FA	System operating rate output	ON	OFF	OFF	OFF	FA=0%	OFF	ON	OFF	OFF	0%<FA<20%		OFF	ON	OFF	20%≤FA<35%		ON	ON	OFF	35%≤FA<50%		OFF	OFF	ON	50%≤FA<65%		ON	OFF	ON	65%≤FA<80%		OFF	ON	ON	80%≤FA<95%		ON	ON	ON	95%≤FA
	Functions	SW16	OUTPUT1	OUTPUT2	OUTPUT3	Operating rate FA																																											
System operating rate output	ON	OFF	OFF	OFF	FA=0%																																												
	OFF	ON	OFF	OFF	0%<FA<20%																																												
		OFF	ON	OFF	20%≤FA<35%																																												
		ON	ON	OFF	35%≤FA<50%																																												
		OFF	OFF	ON	50%≤FA<65%																																												
		ON	OFF	ON	65%≤FA<80%																																												
		OFF	ON	ON	80%≤FA<95%																																												
		ON	ON	ON	95%≤FA																																												
<p>Application</p>  <p>MMY-MAP080 to 120 MMY-MAP140 to 220</p> <p>(max. number installed: 4 pcs)</p> <p>* Install the optional PCB in the outdoor header unit.</p>	<p>Wiring example</p>  <table border="1" data-bbox="564 1258 1430 1518"> <tbody> <tr> <td>C2</td> <td>Connector cable 2 (2)</td> </tr> <tr> <td>CN514</td> <td>Connector on interface side (green)</td> </tr> <tr> <td>K1, K2, K3</td> <td>Relays</td> </tr> <tr> <td>MONITOR</td> <td>Monitoring device</td> </tr> <tr> <td>OUTPUT1</td> <td>Output terminal for each function</td> </tr> <tr> <td>OUTPUT2</td> <td>Output terminal for each function</td> </tr> <tr> <td>OUTPUT3</td> <td>Output terminal for each function</td> </tr> <tr> <td>PJ20</td> <td>Connector on optional PCB side</td> </tr> <tr> <td>TB1</td> <td>Terminal block</td> </tr> </tbody> </table>	C2	Connector cable 2 (2)	CN514	Connector on interface side (green)	K1, K2, K3	Relays	MONITOR	Monitoring device	OUTPUT1	Output terminal for each function	OUTPUT2	Output terminal for each function	OUTPUT3	Output terminal for each function	PJ20	Connector on optional PCB side	TB1	Terminal block																														
C2	Connector cable 2 (2)																																																
CN514	Connector on interface side (green)																																																
K1, K2, K3	Relays																																																
MONITOR	Monitoring device																																																
OUTPUT1	Output terminal for each function																																																
OUTPUT2	Output terminal for each function																																																
OUTPUT3	Output terminal for each function																																																
PJ20	Connector on optional PCB side																																																
TB1	Terminal block																																																

TCB-PCDM4E

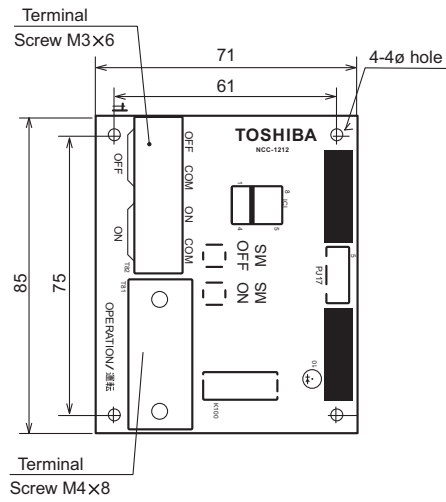

TCB-PCMO4E

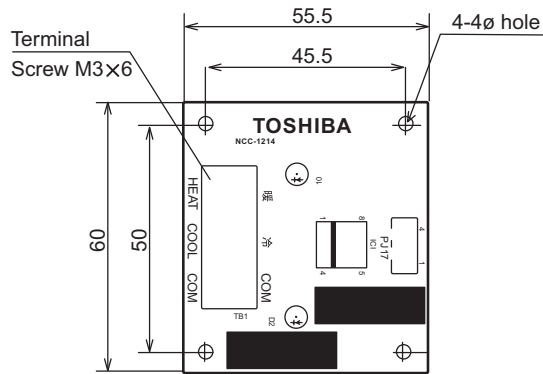

TCB-PCIN4E

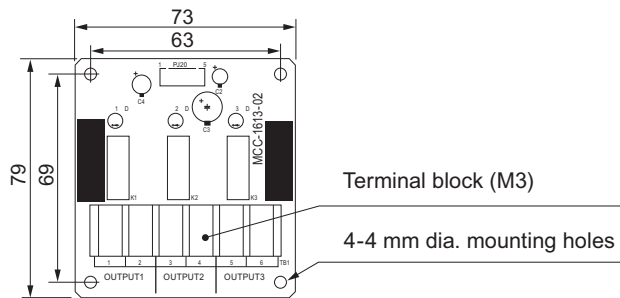



5-10. Part Load performance

Single Unit

MMY-MAP0806HT8P (8HP, 22.4kW system)

Cooling		Compressor + Outdoor Fan Power consumption (kW)															
Outdoor Unit Dry-Bulb (°C)	Outdoor Unit 100% Cooling Capacity (kW)	100%		90%		80%		70%		60%		50%		40%		30%	
		TC	PI	TC	PI	TC	PI	TC	PI	TC	PI	TC	PI	TC	PI	TC	PI
		(kW)	(kW)	(kW)	(kW)	(kW)	(kW)	(kW)	(kW)	(kW)	(kW)	(kW)	(kW)	(kW)	(kW)	(kW)	(kW)
40	20.8	20.8	5.61	18.8	4.65	16.7	3.81	14.6	3.06	12.5	2.43	10.4	1.89	8.34	1.47	6.25	1.14
39	21.2	21.2	5.52	19.1	4.58	17.0	3.75	14.8	3.02	12.7	2.39	10.6	1.87	8.48	1.44	6.36	1.13
37	21.8	21.8	5.36	19.6	4.45	17.4	3.64	15.3	2.93	13.1	2.32	10.9	1.81	8.72	1.40	6.54	1.09
35	22.4	22.4	5.19	20.2	4.31	17.9	3.52	15.7	2.84	13.4	2.25	11.2	1.75	8.96	1.36	6.72	1.06
33	22.4	22.4	4.81	20.2	4.00	17.9	3.27	15.7	2.64	13.4	2.10	11.2	1.64	8.96	1.28	6.72	1.01
31	22.4	22.4	4.47	20.2	3.72	17.9	3.05	15.7	2.47	13.4	1.97	11.2	1.55	8.96	1.21	6.72	0.96
30	22.4	22.4	4.31	20.2	3.59	17.9	2.95	15.7	2.39	13.4	1.90	11.2	1.50	8.96	1.18	6.72	0.93
29	22.4	22.4	4.17	20.2	3.47	17.9	2.85	15.7	2.31	13.4	1.84	11.2	1.46	8.96	1.15	6.72	0.91
27	22.4	22.4	3.89	20.2	3.24	17.9	2.67	15.7	2.17	13.4	1.73	11.2	1.37	8.96	1.08	6.72	0.87
25	22.4	22.4	3.64	20.2	3.04	17.9	2.50	15.7	2.03	13.4	1.63	11.2	1.29	8.96	1.03	6.72	0.82
23	22.4	22.4	3.48	20.2	2.91	17.9	2.40	15.7	1.95	13.4	1.57	11.2	1.25	8.96	0.99	6.72	0.80
21	22.4	22.4	3.41	20.2	2.85	17.9	2.35	15.7	1.92	13.4	1.54	11.2	1.23	8.96	0.98	6.72	0.79
20	22.4	22.4	3.38	20.2	2.82	17.9	2.33	15.7	1.90	13.4	1.53	11.2	1.22	8.96	0.98	6.72	0.79
19	22.4	22.4	3.35	20.2	2.80	17.9	2.31	15.7	1.89	13.4	1.52	11.2	1.22	8.96	0.97	6.72	0.79
17	22.4	22.4	3.29	20.2	2.76	17.9	2.28	15.7	1.86	13.4	1.50	11.2	1.20	8.96	0.97	6.72	0.79
15	22.4	22.4	3.25	20.2	2.72	17.9	2.25	15.7	1.84	13.4	1.49	11.2	1.19	8.96	0.96	6.72	0.78

TC : Total Capacity PI : Power Input
 Indoor air temperature conditions : 27.0 °C dry-bulb / 19.0 °C wet-bulb

Heating			Compressor + Outdoor Fan Power consumption (kW)															
Outdoor Unit		Outdoor Unit 100% Cooling Capacity (kW)	100%		90%		80%		70%		60%		50%		40%		30%	
Dry-Bulb (°C)	Wet-Bulb (°C)		TC	PI	TC	PI	TC	PI	TC	PI	TC	PI	TC	PI	TC	PI	TC	PI
(°C)	(°C)		(kW)	(kW)	(kW)	(kW)	(kW)	(kW)	(kW)	(kW)	(kW)	(kW)	(kW)	(kW)	(kW)	(kW)	(kW)	(kW)
15.0	13.7	25.0	25.0	4.51	22.5	3.81	20.0	3.17	17.5	2.62	15.0	2.14	12.5	1.73	10.0	1.40	7.5	1.15
13.0	11.8	25.0	25.0	4.70	22.5	3.96	20.0	3.29	17.5	2.71	15.0	2.20	12.5	1.78	10.0	1.43	7.5	1.16
11.0	9.8	25.0	25.0	4.92	22.5	4.13	20.0	3.43	17.5	2.81	15.0	2.28	12.5	1.83	10.0	1.46	7.5	1.18
9.0	7.9	25.0	25.0	5.14	22.5	4.31	20.0	3.57	17.5	2.92	15.0	2.36	12.5	1.88	10.0	1.49	7.5	1.20
7.0	6.0	25.0	25.0	5.38	22.5	4.51	20.0	3.72	17.5	3.04	15.0	2.44	12.5	1.94	10.0	1.53	7.5	1.21
5.0	4.1	24.3	24.3	5.36	21.8	4.49	19.4	3.71	17.0	3.03	14.6	2.43	12.1	1.93	9.7	1.53	7.3	1.21
3.0	2.2	23.5	23.5	5.35	21.2	4.48	18.8	3.70	16.5	3.02	14.1	2.43	11.8	1.93	9.4	1.52	7.1	1.21
0.0	-0.7	22.4	22.4	5.32	20.2	4.46	17.9	3.68	15.7	3.00	13.5	2.42	11.2	1.92	9.0	1.51	6.7	1.20
-3.0	-3.7	21.3	21.3	5.30	19.1	4.44	17.0	3.67	14.9	2.99	12.8	2.40	10.6	1.91	8.5	1.51	6.4	1.20
-5.0	-5.6	20.5	20.5	5.28	18.5	4.42	16.4	3.66	14.4	2.98	12.3	2.40	10.3	1.90	8.2	1.50	6.2	1.19
-7.0	-7.6	19.8	19.8	5.26	17.8	4.41	15.8	3.64	13.8	2.97	11.9	2.39	9.9	1.90	7.9	1.50	5.9	1.19
-10	-10.5	18.7	18.7	5.24	16.8	4.39	14.9	3.63	13.1	2.96	11.2	2.38	9.3	1.89	7.5	1.49	5.6	1.18
-14.5	-15.0	16.9	16.9	5.20	15.2	4.35	13.5	3.60	11.8	2.93	10.2	2.36	8.5	1.87	6.8	1.48	5.1	1.17

TC : Total Capacity PI : Power Input
 Indoor air temperature conditions : 20.0 °C dry-bulb



MMY-MAP1006HT8P (10HP, 28kW system)

Cooling			Compressor + Outdoor Fan Power consumption (kW)														
Outdoor Unit Dry-Bulb (°C)	Outdoor Unit 100% Cooling Capacity (kW)	100%		90%		80%		70%		60%		50%		40%		30%	
		TC	PI	TC	PI	TC	PI	TC	PI	TC	PI	TC	PI	TC	PI	TC	PI
		(kW)	(kW)	(kW)	(kW)	(kW)	(kW)	(kW)	(kW)	(kW)	(kW)	(kW)	(kW)	(kW)	(kW)	(kW)	(kW)
40	26.1	26.1	7.84	23.5	6.44	20.8	5.19	18.2	4.11	15.6	3.19	13.0	2.43	10.42	1.84	7.82	1.40
39	26.5	26.5	7.73	23.8	6.34	21.2	5.12	18.5	4.05	15.9	3.14	13.2	2.40	10.59	1.81	7.94	1.38
37	27.3	27.3	7.49	24.5	6.15	21.8	4.96	19.1	3.93	16.4	3.05	13.6	2.32	10.91	1.75	8.18	1.34
35	28.0	28.0	7.26	25.2	5.96	22.4	4.81	19.6	3.80	16.8	2.95	14.0	2.25	11.20	1.70	8.40	1.30
33	28.0	28.0	6.71	25.2	5.51	22.4	4.45	19.6	3.53	16.8	2.75	14.0	2.11	11.20	1.60	8.40	1.23
31	28.0	28.0	6.22	25.2	5.12	22.4	4.14	19.6	3.29	16.8	2.57	14.0	1.98	11.20	1.51	8.40	1.17
30	28.0	28.0	6.00	25.2	4.94	22.4	4.00	19.6	3.18	16.8	2.49	14.0	1.92	11.20	1.47	8.40	1.14
29	28.0	28.0	5.79	25.2	4.76	22.4	3.86	19.6	3.07	16.8	2.41	14.0	1.86	11.20	1.43	8.40	1.11
27	28.0	28.0	5.39	25.2	4.44	22.4	3.60	19.6	2.88	16.8	2.26	14.0	1.75	11.20	1.35	8.40	1.06
25	28.0	28.0	5.03	25.2	4.15	22.4	3.37	19.6	2.69	16.8	2.12	14.0	1.64	11.20	1.28	8.40	1.01
23	28.0	28.0	4.81	25.2	3.97	22.4	3.22	19.6	2.58	16.8	2.03	14.0	1.58	11.20	1.23	8.40	0.98
21	28.0	28.0	4.70	25.2	3.88	22.4	3.16	19.6	2.53	16.8	2.00	14.0	1.56	11.20	1.22	8.40	0.97
20	28.0	28.0	4.66	25.2	3.85	22.4	3.13	19.6	2.51	16.8	1.98	14.0	1.55	11.20	1.21	8.40	0.97
19	28.0	28.0	4.61	25.2	3.81	22.4	3.10	19.6	2.49	16.8	1.97	14.0	1.54	11.20	1.21	8.40	0.96
17	28.0	28.0	4.54	25.2	3.75	22.4	3.06	19.6	2.45	16.8	1.94	14.0	1.52	11.20	1.19	8.40	0.96
15	28.0	28.0	4.47	25.2	3.70	22.4	3.01	19.6	2.42	16.8	1.92	14.0	1.51	11.20	1.19	8.40	0.96

TC : Total Capacity PI : Power Input
 Indoor air temperature conditions : 27.0 °C dry-bulb / 19.0 °C wet-bulb

Heating			Compressor + Outdoor Fan Power consumption (kW)															
Outdoor Unit		Outdoor Unit 100% Cooling Capacity (kW)	100%		90%		80%		70%		60%		50%		40%		30%	
Dry-Bulb (°C)	Wet-Bulb (°C)		TC	PI	TC	PI	TC	PI	TC	PI	TC	PI	TC	PI	TC	PI	TC	PI
(°C)	(°C)		(kW)	(kW)	(kW)	(kW)	(kW)	(kW)	(kW)	(kW)	(kW)	(kW)	(kW)	(kW)	(kW)	(kW)	(kW)	(kW)
15.0	13.7	31.5	31.5	6.00	28.4	5.10	25.2	4.28	22.1	3.55	18.9	2.91	15.8	2.34	12.6	1.86	9.5	1.46
13.0	11.8	31.5	31.5	6.23	28.4	5.29	25.2	4.44	22.1	3.67	18.9	3.00	15.8	2.41	12.6	1.90	9.5	1.49
11.0	9.8	31.5	31.5	6.50	28.4	5.51	25.2	4.62	22.1	3.81	18.9	3.10	15.8	2.48	12.6	1.95	9.5	1.51
9.0	7.9	31.5	31.5	6.78	28.4	5.74	25.2	4.80	22.1	3.95	18.9	3.20	15.8	2.55	12.6	2.00	9.5	1.54
7.0	6.0	31.5	31.5	7.08	28.4	5.98	25.2	4.99	22.1	4.10	18.9	3.32	15.8	2.63	12.6	2.05	9.5	1.57
5.0	4.1	30.5	30.5	7.04	27.4	5.95	24.4	4.96	21.3	4.08	18.3	3.30	15.2	2.62	12.2	2.04	9.1	1.57
3.0	2.2	29.5	29.5	7.00	26.5	5.92	23.6	4.94	20.6	4.06	17.7	3.28	14.7	2.60	11.8	2.03	8.8	1.56
0.0	-0.7	27.9	27.9	6.94	25.1	5.86	22.3	4.89	19.5	4.02	16.8	3.25	14.0	2.58	11.2	2.01	8.4	1.54
-3.0	-3.7	26.3	26.3	6.87	23.7	5.81	21.1	4.85	18.4	3.98	15.8	3.22	13.2	2.56	10.5	1.99	7.9	1.53
-5.0	-5.6	25.3	25.3	6.83	22.8	5.78	20.3	4.82	17.7	3.96	15.2	3.20	12.7	2.54	10.1	1.98	7.6	1.52
-7.0	-7.6	24.2	24.2	6.79	21.8	5.74	19.4	4.79	17.0	3.94	14.5	3.18	12.1	2.53	9.7	1.97	7.3	1.51
-10	-10.5	22.7	22.7	6.73	20.4	5.69	18.2	4.74	15.9	3.90	13.6	3.15	11.4	2.50	9.1	1.95	6.8	1.50
-14.5	-15.0	20.3	20.3	6.63	18.3	5.61	16.2	4.68	14.2	3.84	12.2	3.11	10.2	2.47	8.1	1.92	6.1	1.48

TC : Total Capacity PI : Power Input
 Indoor air temperature conditions : 20.0 °C dry-bulb



MMY-MAP1206HT8P (12HP, 33.5kW system)

Cooling			Compressor + Outdoor Fan Power consumption (kW)														
Outdoor Unit Dry-Bulb (°C)	Outdoor Unit 100% Cooling Capacity (kW)	100%		90%		80%		70%		60%		50%		40%		30%	
		TC	PI	TC	PI	TC	PI	TC	PI	TC	PI	TC	PI	TC	PI	TC	PI
		(kW)	(kW)	(kW)	(kW)	(kW)	(kW)	(kW)	(kW)	(kW)	(kW)	(kW)	(kW)	(kW)	(kW)	(kW)	(kW)
40	31.2	31.2	10.2	28.1	8.39	24.9	6.80	21.8	5.39	18.7	4.15	15.6	3.09	12.5	2.21	9.35	1.51
39	31.7	31.7	10.0	28.5	8.27	25.3	6.70	22.2	5.31	19.0	4.09	15.8	3.04	12.67	2.18	9.50	1.48
37	32.6	32.6	9.71	29.4	8.02	26.1	6.50	22.8	5.14	19.6	3.96	16.3	2.95	13.05	2.11	9.79	1.44
35	33.5	33.5	9.41	30.2	7.77	26.8	6.29	23.5	4.98	20.1	3.84	16.8	2.86	13.40	2.04	10.05	1.39
33	33.5	33.5	8.71	30.2	7.20	26.8	5.84	23.5	4.63	20.1	3.57	16.8	2.66	13.40	1.91	10.05	1.31
31	33.5	33.5	8.09	30.2	6.69	26.8	5.43	23.5	4.31	20.1	3.33	16.8	2.49	13.40	1.79	10.05	1.23
30	33.5	33.5	7.81	30.2	6.45	26.8	5.24	23.5	4.16	20.1	3.22	16.8	2.41	13.40	1.73	10.05	1.20
29	33.5	33.5	7.53	30.2	6.23	26.8	5.06	23.5	4.02	20.1	3.11	16.8	2.33	13.40	1.68	10.05	1.16
27	33.5	33.5	7.03	30.2	5.82	26.8	4.72	23.5	3.76	20.1	2.91	16.8	2.18	13.40	1.58	10.05	1.09
25	33.5	33.5	6.56	30.2	5.43	26.8	4.42	23.5	3.51	20.1	2.72	16.8	2.05	13.40	1.48	10.05	1.03
23	33.5	33.5	6.27	30.2	5.19	26.8	4.23	23.5	3.36	20.1	2.61	16.8	1.96	13.40	1.43	10.05	1.00
21	33.5	33.5	6.14	30.2	5.09	26.8	4.14	23.5	3.30	20.1	2.56	16.8	1.93	13.40	1.40	10.05	0.98
20	33.5	33.5	6.08	30.2	5.04	26.8	4.10	23.5	3.27	20.1	2.54	16.8	1.91	13.40	1.39	10.05	0.98
19	33.5	33.5	6.02	30.2	4.99	26.8	4.07	23.5	3.24	20.1	2.52	16.8	1.90	13.40	1.38	10.05	0.97
17	33.5	33.5	5.93	30.2	4.91	26.8	4.00	23.5	3.19	20.1	2.48	16.8	1.87	13.40	1.37	10.05	0.97
15	33.5	33.5	5.84	30.2	4.85	26.8	3.95	23.5	3.15	20.1	2.45	16.8	1.85	13.40	1.35	10.05	0.97

TC : Total Capacity PI : Power Input
 Indoor air temperature conditions : 27.0 °C dry-bulb / 19.0 °C wet-bulb

Heating			Compressor + Outdoor Fan Power consumption (kW)															
Outdoor Unit		Outdoor Unit 100% Cooling Capacity (kW)	100%		90%		80%		70%		60%		50%		40%		30%	
Dry-Bulb (°C)	Wet-Bulb (°C)		TC	PI	TC	PI	TC	PI	TC	PI	TC	PI	TC	PI	TC	PI	TC	PI
(°C)	(°C)		(kW)	(kW)	(kW)	(kW)	(kW)	(kW)	(kW)	(kW)	(kW)	(kW)	(kW)	(kW)	(kW)	(kW)	(kW)	(kW)
15.0	13.7	37.5	37.5	7.88	33.8	6.73	30.0	5.67	26.3	4.71	22.5	3.83	18.8	3.05	15.0	2.35	11.3	1.75
13.0	11.8	37.5	37.5	8.18	33.8	6.98	30.0	5.88	26.3	4.87	22.5	3.96	18.8	3.14	15.0	2.41	11.3	1.79
11.0	9.8	37.5	37.5	8.51	33.8	7.26	30.0	6.10	26.3	5.05	22.5	4.09	18.8	3.24	15.0	2.49	11.3	1.83
9.0	7.9	37.5	37.5	8.86	33.8	7.55	30.0	6.34	26.3	5.23	22.5	4.24	18.8	3.35	15.0	2.56	11.3	1.88
7.0	6.0	37.5	37.5	9.24	33.8	7.86	30.0	6.59	26.3	5.44	22.5	4.39	18.8	3.46	15.0	2.64	11.3	1.93
5.0	4.1	36.2	36.2	9.17	32.5	7.80	28.9	6.54	25.3	5.39	21.7	4.36	18.1	3.43	14.5	2.62	10.8	1.91
3.0	2.2	34.8	34.8	9.10	31.3	7.74	27.9	6.49	24.4	5.35	20.9	4.32	17.4	3.41	13.9	2.60	10.4	1.90
0.0	-0.7	32.8	32.8	8.99	29.5	7.65	26.2	6.41	22.9	5.29	19.7	4.27	16.4	3.37	13.1	2.57	9.8	1.88
-3.0	-3.7	30.6	30.6	8.88	27.6	7.55	24.5	6.34	21.5	5.22	18.4	4.22	15.3	3.32	12.3	2.54	9.2	1.85
-5.0	-5.6	29.3	29.3	8.81	26.4	7.49	23.4	6.29	20.5	5.18	17.6	4.19	14.7	3.30	11.7	2.52	8.8	1.84
-7.0	-7.6	27.9	27.9	8.74	25.1	7.43	22.3	6.23	19.5	5.14	16.7	4.15	13.9	3.27	11.2	2.49	8.4	1.82
-10	-10.5	25.8	25.8	8.63	23.3	7.34	20.7	6.16	18.1	5.08	15.5	4.10	12.9	3.23	10.3	2.46	7.8	1.80
-14.5	-15.0	22.7	22.7	8.46	20.4	7.20	18.1	6.04	15.9	4.98	13.6	4.02	11.3	3.17	9.1	2.42	6.8	1.77

TC : Total Capacity PI : Power Input
 Indoor air temperature conditions : 20.0 °C dry-bulb



MMY-MAP1406HT8P (14HP, 40kW system)

Cooling			Compressor + Outdoor Fan Power consumption (kW)														
Outdoor Unit Dry-Bulb (°C)	Outdoor Unit 100% Cooling Capacity (kW)	100%		90%		80%		70%		60%		50%		40%		30%	
		TC	PI	TC	PI	TC	PI	TC	PI	TC	PI	TC	PI	TC	PI	TC	PI
		(kW)	(kW)	(kW)	(kW)	(kW)	(kW)	(kW)	(kW)	(kW)	(kW)	(kW)	(kW)	(kW)	(kW)	(kW)	(kW)
40	37.2	37.2	12.4	33.5	10.3	29.8	8.32	26.1	6.59	22.3	5.08	18.6	3.79	14.9	2.72	11.2	1.87
39	37.8	37.8	12.2	34.0	10.1	30.3	8.19	26.5	6.49	22.7	5.01	18.9	3.74	15.1	2.68	11.3	1.84
37	39.0	39.0	11.9	35.1	9.80	31.2	7.95	27.3	6.30	23.4	4.86	19.5	3.62	15.6	2.60	11.7	1.79
35	40.0	40.0	11.5	36.0	9.50	32.0	7.70	28.0	6.10	24.0	4.70	20.0	3.51	16.0	2.52	12.0	1.73
33	40.0	40.0	10.6	36.0	8.80	32.0	7.14	28.0	5.66	24.0	4.38	20.0	3.27	16.0	2.36	12.0	1.63
31	40.0	40.0	9.89	36.0	8.18	32.0	6.64	28.0	5.27	24.0	4.08	20.0	3.06	16.0	2.21	12.0	1.53
30	40.0	40.0	9.54	36.0	7.89	32.0	6.41	28.0	5.09	24.0	3.94	20.0	2.96	16.0	2.14	12.0	1.49
29	40.0	40.0	9.21	36.0	7.62	32.0	6.19	28.0	4.92	24.0	3.81	20.0	2.86	16.0	2.07	12.0	1.44
27	40.0	40.0	8.59	36.0	7.11	32.0	5.78	28.0	4.60	24.0	3.57	20.0	2.68	16.0	1.95	12.0	1.36
25	40.0	40.0	8.02	36.0	6.65	32.0	5.41	28.0	4.31	24.0	3.34	20.0	2.52	16.0	1.83	12.0	1.29
23	40.0	40.0	7.67	36.0	6.35	32.0	5.17	28.0	4.12	24.0	3.20	20.0	2.42	16.0	1.76	12.0	1.24
21	40.0	40.0	7.51	36.0	6.22	32.0	5.07	28.0	4.04	24.0	3.14	20.0	2.37	16.0	1.74	12.0	1.23
20	40.0	40.0	7.43	36.0	6.16	32.0	5.02	28.0	4.00	24.0	3.12	20.0	2.36	16.0	1.72	12.0	1.22
19	40.0	40.0	7.37	36.0	6.11	32.0	4.98	28.0	3.97	24.0	3.09	20.0	2.34	16.0	1.71	12.0	1.21
17	40.0	40.0	7.25	36.0	6.01	32.0	4.90	28.0	3.91	24.0	3.05	20.0	2.31	16.0	1.69	12.0	1.20
15	40.0	40.0	7.14	36.0	5.93	32.0	4.83	28.0	3.86	24.0	3.01	20.0	2.28	16.0	1.67	12.0	1.19

TC : Total Capacity PI : Power Input
 Indoor air temperature conditions : 27.0 °C dry-bulb / 19.0 °C wet-bulb

Heating			Compressor + Outdoor Fan Power consumption (kW)															
Outdoor Unit Dry-Bulb (°C)	Outdoor Unit Wet-Bulb (°C)	Outdoor Unit 100% Cooling Capacity (kW)	100%		90%		80%		70%		60%		50%		40%		30%	
			TC	PI	TC	PI	TC	PI	TC	PI	TC	PI	TC	PI	TC	PI	TC	PI
			(kW)	(kW)	(kW)	(kW)	(kW)	(kW)	(kW)	(kW)	(kW)	(kW)	(kW)	(kW)	(kW)	(kW)	(kW)	(kW)
15.0	13.7	45.0	45.0	8.91	40.5	7.54	36.0	6.31	31.5	5.22	27.0	4.29	22.5	3.49	18.0	2.85	13.5	2.35
13.0	11.8	45.0	45.0	9.28	40.5	7.83	36.0	6.54	31.5	5.40	27.0	4.41	22.5	3.58	18.0	2.90	13.5	2.38
11.0	9.8	45.0	45.0	9.70	40.5	8.17	36.0	6.80	31.5	5.60	27.0	4.56	22.5	3.68	18.0	2.96	13.5	2.41
9.0	7.9	45.0	45.0	10.1	40.5	8.52	36.0	7.08	31.5	5.81	27.0	4.71	22.5	3.78	18.0	3.03	13.5	2.44
7.0	6.0	45.0	45.0	10.6	40.5	8.90	36.0	7.38	31.5	6.04	27.0	4.88	22.5	3.90	18.0	3.10	13.5	2.48
5.0	4.1	43.6	43.6	10.5	39.2	8.85	34.8	7.33	30.5	6.00	26.1	4.85	21.8	3.87	17.4	3.08	13.1	2.47
3.0	2.2	42.1	42.1	10.5	37.9	8.80	33.7	7.29	29.5	5.97	25.3	4.82	21.1	3.85	16.8	3.06	12.6	2.45
0.0	-0.7	39.9	39.9	10.4	35.9	8.72	31.9	7.23	27.9	5.91	23.9	4.78	19.9	3.82	16.0	3.04	12.0	2.43
-3.0	-3.7	37.6	37.6	10.3	33.8	8.64	30.1	7.16	26.3	5.86	22.6	4.73	18.8	3.78	15.0	3.01	11.3	2.41
-5.0	-5.6	36.2	36.2	10.2	32.5	8.59	28.9	7.12	25.3	5.83	21.7	4.71	18.1	3.76	14.5	2.99	10.8	2.39
-7.0	-7.6	34.6	34.6	10.2	31.2	8.53	27.7	7.08	24.2	5.79	20.8	4.68	17.3	3.74	13.9	2.97	10.4	2.38
-10	-10.5	32.4	32.4	10.1	29.2	8.46	25.9	7.01	22.7	5.74	19.5	4.63	16.2	3.70	13.0	2.95	9.7	2.36
-14.5	-15.0	29.0	29.0	9.93	26.1	8.34	23.2	6.91	20.3	5.66	17.4	4.57	14.5	3.65	11.6	2.90	8.7	2.32

TC : Total Capacity PI : Power Input
 Indoor air temperature conditions : 20.0 °C dry-bulb



MMY-MAP1606HT8P (16HP, 45kW system)

Cooling			Compressor + Outdoor Fan Power consumption (kW)															
Outdoor Unit Dry-Bulb (°C)		Outdoor Unit 100% Cooling Capacity (kW)	100%		90%		80%		70%		60%		50%		40%		30%	
Dry-Bulb (°C)	Wet-Bulb (°C)		TC	PI	TC	PI	TC	PI	TC	PI	TC	PI	TC	PI	TC	PI	TC	PI
			(kW)	(kW)	(kW)	(kW)	(kW)	(kW)	(kW)	(kW)	(kW)	(kW)	(kW)	(kW)	(kW)	(kW)	(kW)	(kW)
40		41.9	41.9	14.7	37.7	12.1	33.5	9.74	29.3	7.67	25.1	5.86	20.9	4.31	16.8	3.03	12.6	2.02
39		42.5	42.5	14.5	38.3	11.9	34.0	9.60	29.8	7.55	25.5	5.77	21.3	4.25	17.0	2.99	12.8	1.99
37		43.8	43.8	14.0	39.4	11.5	35.1	9.31	30.7	7.32	26.3	5.59	21.9	4.12	17.5	2.90	13.1	1.93
35		45.0	45.0	13.6	40.5	11.2	36.0	9.02	31.5	7.09	27.0	5.42	22.5	3.99	18.0	2.80	13.5	1.87
33		45.0	45.0	12.6	40.5	10.4	36.0	8.35	31.5	6.58	27.0	5.03	22.5	3.71	18.0	2.62	13.5	1.75
31		45.0	45.0	11.7	40.5	9.61	36.0	7.76	31.5	6.12	27.0	4.68	22.5	3.46	18.0	2.45	13.5	1.64
30		45.0	45.0	11.3	40.5	9.27	36.0	7.49	31.5	5.90	27.0	4.52	22.5	3.35	18.0	2.37	13.5	1.59
29		45.0	45.0	10.9	40.5	8.95	36.0	7.23	31.5	5.70	27.0	4.37	22.5	3.24	18.0	2.29	13.5	1.55
27		45.0	45.0	10.1	40.5	8.34	36.0	6.74	31.5	5.32	27.0	4.09	22.5	3.03	18.0	2.15	13.5	1.46
25		45.0	45.0	9.45	40.5	7.79	36.0	6.30	31.5	4.98	27.0	3.82	22.5	2.84	18.0	2.02	13.5	1.37
23		45.0	45.0	9.03	40.5	7.44	36.0	6.02	31.5	4.76	27.0	3.66	22.5	2.72	18.0	1.94	13.5	1.32
21		45.0	45.0	8.83	40.5	7.29	36.0	5.90	31.5	4.66	27.0	3.59	22.5	2.67	18.0	1.91	13.5	1.30
20		45.0	45.0	8.74	40.5	7.22	36.0	5.84	31.5	4.62	27.0	3.56	22.5	2.65	18.0	1.89	13.5	1.29
19		45.0	45.0	8.66	40.5	7.15	36.0	5.79	31.5	4.58	27.0	3.53	22.5	2.63	18.0	1.88	13.5	1.29
17		45.0	45.0	8.52	40.5	7.03	36.0	5.70	31.5	4.51	27.0	3.47	22.5	2.59	18.0	1.85	13.5	1.27
15		45.0	45.0	8.40	40.5	6.93	36.0	5.62	31.5	4.45	27.0	3.43	22.5	2.56	18.0	1.83	13.5	1.26

TC : Total Capacity PI : Power Input
 Indoor air temperature conditions : 27.0 °C dry-bulb / 19.0 °C wet-bulb

Heating			Compressor + Outdoor Fan Power consumption (kW)															
Outdoor Unit		Outdoor Unit 100% Cooling Capacity (kW)	100%		90%		80%		70%		60%		50%		40%		30%	
Dry-Bulb (°C)	Wet-Bulb (°C)		TC	PI	TC	PI	TC	PI	TC	PI	TC	PI	TC	PI	TC	PI	TC	PI
			(kW)	(kW)	(kW)	(kW)	(kW)	(kW)	(kW)	(kW)	(kW)	(kW)	(kW)	(kW)	(kW)	(kW)	(kW)	(kW)
15.0	13.7	50.0	50.0	10.5	45.0	8.84	40.0	7.37	35.0	6.08	30.0	4.96	25.0	4.01	20.0	3.24	15.0	2.64
13.0	11.8	50.0	50.0	10.9	45.0	9.19	40.0	7.65	35.0	6.29	30.0	5.11	25.0	4.12	20.0	3.30	15.0	2.67
11.0	9.8	50.0	50.0	11.4	45.0	9.60	40.0	7.97	35.0	6.53	30.0	5.29	25.0	4.24	20.0	3.38	15.0	2.71
9.0	7.9	50.0	50.0	11.9	45.0	10.0	40.0	8.30	35.0	6.78	30.0	5.47	25.0	4.36	20.0	3.46	15.0	2.75
7.0	6.0	50.0	50.0	12.5	45.0	10.5	40.0	8.65	35.0	7.05	30.0	5.67	25.0	4.50	20.0	3.54	15.0	2.80
5.0	4.1	48.2	48.2	12.4	43.4	10.4	38.6	8.59	33.7	7.00	28.9	5.62	24.1	4.46	19.3	3.51	14.5	2.78
3.0	2.2	46.4	46.4	12.3	41.8	10.3	37.1	8.52	32.5	6.95	27.9	5.58	23.2	4.43	18.6	3.49	13.9	2.76
0.0	-0.7	43.7	43.7	12.2	39.3	10.2	34.9	8.42	30.6	6.86	26.2	5.52	21.8	4.38	17.5	3.45	13.1	2.72
-3.0	-3.7	40.9	40.9	12.0	36.8	10.1	32.7	8.32	28.6	6.78	24.5	5.45	20.4	4.32	16.3	3.40	12.3	2.69
-5.0	-5.6	39.1	39.1	11.9	35.2	10.0	31.3	8.25	27.3	6.73	23.4	5.40	19.5	4.29	15.6	3.38	11.7	2.67
-7.0	-7.6	37.2	37.2	11.8	33.5	9.90	29.7	8.18	26.0	6.67	22.3	5.36	18.6	4.25	14.9	3.35	11.2	2.65
-10	-10.5	34.5	34.5	11.7	31.0	9.78	27.6	8.08	24.1	6.59	20.7	5.29	17.2	4.20	13.8	3.31	10.3	2.61
-14.5	-15.0	30.2	30.2	11.4	27.2	9.59	24.2	7.93	21.1	6.46	18.1	5.19	15.1	4.12	12.1	3.24	9.1	2.56

TC : Total Capacity PI : Power Input
 Indoor air temperature conditions : 20.0 °C dry-bulb



MMY-MAP1816HT8P (18HP, 50.4kW system)

Cooling			Compressor + Outdoor Fan Power consumption (kW)															
Outdoor Unit Dry-Bulb (°C)		Outdoor Unit 100% Cooling Capacity (kW)	100%		90%		80%		70%		60%		50%		40%		30%	
			TC (kW)	PI (kW)	TC (kW)	PI (kW)	TC (kW)	PI (kW)	TC (kW)	PI (kW)	TC (kW)	PI (kW)	TC (kW)	PI (kW)	TC (kW)	PI (kW)	TC (kW)	PI (kW)
40		46.9	46.9	15.1	42.2	12.6	37.5	10.4	32.8	8.33	28.1	6.53	23.5	4.95	18.8	3.60	14.1	2.48
39		47.7	47.7	14.9	42.9	12.4	38.1	10.2	33.4	8.21	28.6	6.43	23.8	4.88	19.1	3.55	14.3	2.44
37		49.1	49.1	14.4	44.2	12.1	39.3	9.91	34.4	7.96	29.4	6.24	24.5	4.73	19.6	3.44	14.7	2.37
35		50.4	50.4	14.0	45.4	11.7	40.3	9.60	35.3	7.71	30.2	6.04	25.2	4.58	20.2	3.33	15.1	2.29
33		50.4	50.4	13.0	45.4	10.9	40.3	8.92	35.3	7.18	30.2	5.63	25.2	4.28	20.2	3.12	15.1	2.15
31		50.4	50.4	12.1	45.4	10.1	40.3	8.32	35.3	6.70	30.2	5.26	25.2	4.00	20.2	2.92	15.1	2.03
30		50.4	50.4	11.7	45.4	9.77	40.3	8.04	35.3	6.48	30.2	5.09	25.2	3.87	20.2	2.83	15.1	1.97
29		50.4	50.4	11.3	45.4	9.44	40.3	7.77	35.3	6.26	30.2	4.92	25.2	3.75	20.2	2.75	15.1	1.91
27		50.4	50.4	10.5	45.4	8.83	40.3	7.27	35.3	5.87	30.2	4.62	25.2	3.52	20.2	2.58	15.1	1.80
25		50.4	50.4	9.87	45.4	8.26	40.3	6.81	35.3	5.50	30.2	4.33	25.2	3.31	20.2	2.43	15.1	1.70
23		50.4	50.4	9.44	45.4	7.91	40.3	6.52	35.3	5.27	30.2	4.15	25.2	3.18	20.2	2.34	15.1	1.64
21		50.4	50.4	9.25	45.4	7.76	40.3	6.40	35.3	5.17	30.2	4.08	25.2	3.12	20.2	2.30	15.1	1.61
20		50.4	50.4	9.17	45.4	7.69	40.3	6.34	35.3	5.13	30.2	4.05	25.2	3.10	20.2	2.28	15.1	1.60
19		50.4	50.4	9.09	45.4	7.63	40.3	6.29	35.3	5.09	30.2	4.02	25.2	3.08	20.2	2.27	15.1	1.59
17		50.4	50.4	8.95	45.4	7.51	40.3	6.20	35.3	5.02	30.2	3.96	25.2	3.04	20.2	2.24	15.1	1.58
15		50.4	50.4	8.83	45.4	7.41	40.3	6.12	35.3	4.95	30.2	3.92	25.2	3.00	20.2	2.22	15.1	1.56

TC : Total Capacity PI : Power Input
 Indoor air temperature conditions : 27.0 °C dry-bulb / 19.0 °C wet-bulb

Heating			Compressor + Outdoor Fan Power consumption (kW)															
Outdoor Unit		Outdoor Unit 100% Cooling Capacity (kW)	100%		90%		80%		70%		60%		50%		40%		30%	
Dry-Bulb (°C)	Wet-Bulb (°C)		TC (kW)	PI (kW)	TC (kW)	PI (kW)	TC (kW)	PI (kW)	TC (kW)	PI (kW)	TC (kW)	PI (kW)	TC (kW)	PI (kW)	TC (kW)	PI (kW)	TC (kW)	PI (kW)
15.0	13.7	56.0	56.0	11.6	50.4	9.98	44.8	8.45	39.2	7.05	33.6	5.78	28.0	4.63	22.4	3.61	16.8	2.72
13.0	11.8	56.0	56.0	12.1	50.4	10.3	44.8	8.74	39.2	7.28	33.6	5.96	28.0	4.76	22.4	3.70	16.8	2.78
11.0	9.8	56.0	56.0	12.6	50.4	10.7	44.8	9.07	39.2	7.55	33.6	6.16	28.0	4.91	22.4	3.81	16.8	2.84
9.0	7.9	56.0	56.0	13.1	50.4	11.2	44.8	9.41	39.2	7.81	33.6	6.36	28.0	5.06	22.4	3.91	16.8	2.91
7.0	6.0	56.0	56.0	13.6	50.4	11.6	44.8	9.78	39.2	8.10	33.6	6.59	28.0	5.23	22.4	4.03	16.8	2.98
5.0	4.1	54.2	54.2	13.5	48.8	11.5	43.4	9.72	37.9	8.06	32.5	6.55	27.1	5.20	21.7	4.00	16.3	2.97
3.0	2.2	52.4	52.4	13.4	47.2	11.5	41.9	9.67	36.7	8.01	31.4	6.51	26.2	5.17	21.0	3.98	15.7	2.95
0.0	-0.7	49.6	49.6	13.3	44.7	11.4	39.7	9.58	34.8	7.94	29.8	6.45	24.8	5.12	19.9	3.95	14.9	2.92
-3.0	-3.7	46.8	46.8	13.2	42.1	11.3	37.4	9.49	32.8	7.87	28.1	6.40	23.4	5.08	18.7	3.91	14.0	2.90
-5.0	-5.6	45.0	45.0	13.1	40.5	11.2	36.0	9.44	31.5	7.82	27.0	6.36	22.5	5.05	18.0	3.89	13.5	2.88
-7.0	-7.6	43.1	43.1	13.0	38.8	11.1	34.5	9.38	30.2	7.77	25.9	6.32	21.6	5.02	17.2	3.86	12.9	2.86
-10	-10.5	40.4	40.4	12.9	36.3	11.0	32.3	9.29	28.3	7.70	24.2	6.26	20.2	4.97	16.1	3.83	12.1	2.83
-14.5	-15.0	36.1	36.1	12.7	32.5	10.9	28.9	9.16	25.3	7.59	21.7	6.17	18.0	4.90	14.4	3.77	10.8	2.79

TC : Total Capacity PI : Power Input
 Indoor air temperature conditions : 20.0 °C dry-bulb



MMY-MAP2016HT8P (20HP, 56kW system)

Cooling			Compressor + Outdoor Fan Power consumption (kW)															
Outdoor Unit Dry-Bulb (°C)		Outdoor Unit 100% Cooling Capacity (kW)	100%		90%		80%		70%		60%		50%		40%		30%	
			TC (kW)	PI (kW)	TC (kW)	PI (kW)	TC (kW)	PI (kW)	TC (kW)	PI (kW)	TC (kW)	PI (kW)	TC (kW)	PI (kW)	TC (kW)	PI (kW)	TC (kW)	PI (kW)
40		52.1	52.1	19.2	46.9	15.7	41.7	12.5	36.5	9.75	31.3	7.38	26.1	5.40	20.8	3.81	15.6	2.62
39		52.9	52.9	18.9	47.7	15.4	42.4	12.3	37.1	9.60	31.8	7.27	26.5	5.32	21.2	3.75	15.9	2.58
37		54.5	54.5	18.4	49.1	15.0	43.6	12.0	38.2	9.31	32.7	7.05	27.3	5.16	21.8	3.64	16.4	2.50
35		56.0	56.0	17.9	50.4	14.5	44.8	11.6	39.2	9.02	33.6	6.83	28.0	4.99	22.4	3.53	16.8	2.42
33		56.0	56.0	16.4	50.4	13.4	44.8	10.7	39.2	8.35	33.6	6.33	28.0	4.64	22.4	3.30	16.8	2.28
31		56.0	56.0	15.2	50.4	12.4	44.8	9.93	39.2	7.75	33.6	5.89	28.0	4.33	22.4	3.09	16.8	2.15
30		56.0	56.0	14.7	50.4	12.0	44.8	9.58	39.2	7.48	33.6	5.68	28.0	4.19	22.4	2.99	16.8	2.09
29		56.0	56.0	14.1	50.4	11.5	44.8	9.24	39.2	7.22	33.6	5.49	28.0	4.05	22.4	2.90	16.8	2.03
27		56.0	56.0	13.2	50.4	10.8	44.8	8.61	39.2	6.73	33.6	5.13	28.0	3.79	22.4	2.72	16.8	1.92
25		56.0	56.0	12.3	50.4	10.0	44.8	8.03	39.2	6.29	33.6	4.80	28.0	3.55	22.4	2.56	16.8	1.82
23		56.0	56.0	11.7	50.4	9.57	44.8	7.67	39.2	6.01	33.6	4.59	28.0	3.41	22.4	2.46	16.8	1.75
21		56.0	56.0	11.4	50.4	9.36	44.8	7.50	39.2	5.88	33.6	4.50	28.0	3.34	22.4	2.42	16.8	1.73
20		56.0	56.0	11.3	50.4	9.26	44.8	7.43	39.2	5.83	33.6	4.46	28.0	3.32	22.4	2.40	16.8	1.72
19		56.0	56.0	11.2	50.4	9.17	44.8	7.36	39.2	5.78	33.6	4.42	28.0	3.29	22.4	2.39	16.8	1.71
17		56.0	56.0	11.0	50.4	9.02	44.8	7.24	39.2	5.68	33.6	4.35	28.0	3.24	22.4	2.36	16.8	1.70
15		56.0	56.0	10.9	50.4	8.88	44.8	7.13	39.2	5.60	33.6	4.29	28.0	3.20	22.4	2.34	16.8	1.69

TC : Total Capacity PI : Power Input
 Indoor air temperature conditions : 27.0 °C dry-bulb / 19.0 °C wet-bulb

Heating			Compressor + Outdoor Fan Power consumption (kW)															
Outdoor Unit		Outdoor Unit 100% Cooling Capacity (kW)	100%		90%		80%		70%		60%		50%		40%		30%	
Dry-Bulb (°C)	Wet-Bulb (°C)		TC (kW)	PI (kW)	TC (kW)	PI (kW)	TC (kW)	PI (kW)	TC (kW)	PI (kW)	TC (kW)	PI (kW)	TC (kW)	PI (kW)	TC (kW)	PI (kW)	TC (kW)	PI (kW)
15.0	13.7	63.0	63.0	14.1	56.7	12.1	50.4	10.2	44.1	8.49	37.8	6.92	31.5	5.49	25.2	4.20	18.9	3.07
13.0	11.8	63.0	63.0	14.6	56.7	12.5	50.4	10.6	44.1	8.78	37.8	7.14	31.5	5.65	25.2	4.32	18.9	3.14
11.0	9.8	63.0	63.0	15.2	56.7	13.0	50.4	11.0	44.1	9.11	37.8	7.39	31.5	5.84	25.2	4.45	18.9	3.23
9.0	7.9	63.0	63.0	15.8	56.7	13.5	50.4	11.4	44.1	9.44	37.8	7.65	31.5	6.03	25.2	4.59	18.9	3.32
7.0	6.0	63.0	63.0	16.5	56.7	14.1	50.4	11.8	44.1	9.80	37.8	7.93	31.5	6.24	25.2	4.73	18.9	3.41
5.0	4.1	60.7	60.7	16.4	54.7	14.0	48.6	11.8	42.5	9.72	36.4	7.87	30.4	6.19	24.3	4.70	18.2	3.38
3.0	2.2	58.5	58.5	16.2	52.6	13.9	46.8	11.7	40.9	9.65	35.1	7.81	29.2	6.14	23.4	4.66	17.5	3.36
0.0	-0.7	55.0	55.0	16.1	49.5	13.7	44.0	11.5	38.5	9.53	33.0	7.71	27.5	6.07	22.0	4.61	16.5	3.32
-3.0	-3.7	51.5	51.5	15.9	46.3	13.5	41.2	11.4	36.0	9.42	30.9	7.62	25.7	6.00	20.6	4.55	15.4	3.28
-5.0	-5.6	49.2	49.2	15.7	44.3	13.4	39.4	11.3	34.5	9.34	29.5	7.56	24.6	5.95	19.7	4.51	14.8	3.25
-7.0	-7.6	46.9	46.9	15.6	42.2	13.3	37.5	11.2	32.8	9.26	28.1	7.49	23.4	5.90	18.7	4.48	14.1	3.23
-10	-10.5	43.4	43.4	15.4	39.1	13.2	34.7	11.1	30.4	9.15	26.0	7.40	21.7	5.83	17.4	4.42	13.0	3.19
-14.5	-15.0	38.1	38.1	15.1	34.3	12.9	30.5	10.9	26.6	8.97	22.8	7.26	19.0	5.71	15.2	4.34	11.4	3.12

TC : Total Capacity PI : Power Input
 Indoor air temperature conditions : 20.0 °C dry-bulb



MMY-MAP2216HT8P (22HP, 61.5kW system)

Cooling			Compressor + Outdoor Fan Power consumption (kW)															
Outdoor Unit Dry-Bulb (°C)		Outdoor Unit 100% Cooling Capacity (kW)	100%		90%		80%		70%		60%		50%		40%		30%	
			TC (kW)	PI (kW)	TC (kW)	PI (kW)	TC (kW)	PI (kW)	TC (kW)	PI (kW)	TC (kW)	PI (kW)	TC (kW)	PI (kW)	TC (kW)	PI (kW)	TC (kW)	PI (kW)
40		57.2	57.2	22.7	51.5	18.5	45.8	14.7	40.1	11.4	34.3	8.59	28.6	6.22	22.9	4.31	17.2	2.86
39		58.2	58.2	22.4	52.3	18.2	46.5	14.5	40.7	11.3	34.9	8.47	29.1	6.13	23.3	4.25	17.4	2.82
37		59.9	59.9	21.7	53.9	17.6	47.9	14.1	41.9	10.9	35.9	8.21	29.9	5.94	24.0	4.12	18.0	2.73
35		61.5	61.5	21.0	55.4	17.1	49.2	13.6	43.1	10.6	36.9	7.95	30.8	5.76	24.6	3.99	18.5	2.65
33		61.5	61.5	19.4	55.4	15.8	49.2	12.6	43.1	9.78	36.9	7.37	30.8	5.35	24.6	3.72	18.5	2.48
31		61.5	61.5	18.0	55.4	14.6	49.2	11.7	43.1	9.08	36.9	6.85	30.8	4.98	24.6	3.47	18.5	2.33
30		61.5	61.5	17.3	55.4	14.1	49.2	11.2	43.1	8.75	36.9	6.61	30.8	4.81	24.6	3.36	18.5	2.26
29		61.5	61.5	16.7	55.4	13.6	49.2	10.8	43.1	8.44	36.9	6.38	30.8	4.65	24.6	3.25	18.5	2.20
27		61.5	61.5	15.5	55.4	12.7	49.2	10.1	43.1	7.87	36.9	5.95	30.8	4.34	24.6	3.05	18.5	2.07
25		61.5	61.5	14.5	55.4	11.8	49.2	9.43	43.1	7.35	36.9	5.56	30.8	4.07	24.6	2.86	18.5	1.95
23		61.5	61.5	13.8	55.4	11.3	49.2	9.00	43.1	7.02	36.9	5.32	30.8	3.89	24.6	2.75	18.5	1.88
21		61.5	61.5	13.5	55.4	11.0	49.2	8.80	43.1	6.87	36.9	5.21	30.8	3.82	24.6	2.70	18.5	1.86
20		61.5	61.5	13.3	55.4	10.9	49.2	8.71	43.1	6.80	36.9	5.16	30.8	3.79	24.6	2.68	18.5	1.85
19		61.5	61.5	13.2	55.4	10.8	49.2	8.63	43.1	6.74	36.9	5.11	30.8	3.75	24.6	2.66	18.5	1.83
17		61.5	61.5	13.0	55.4	10.6	49.2	8.48	43.1	6.63	36.9	5.03	30.8	3.70	24.6	2.63	18.5	1.82
15		61.5	61.5	12.8	55.4	10.4	49.2	8.36	43.1	6.53	36.9	4.96	30.8	3.65	24.6	2.60	18.5	1.80

TC : Total Capacity PI : Power Input
 Indoor air temperature conditions : 27.0 °C dry-bulb / 19.0 °C wet-bulb

Heating			Compressor + Outdoor Fan Power consumption (kW)															
Outdoor Unit		Outdoor Unit 100% Cooling Capacity (kW)	100%		90%		80%		70%		60%		50%		40%		30%	
Dry-Bulb (°C)	Wet-Bulb (°C)		TC (kW)	PI (kW)	TC (kW)	PI (kW)	TC (kW)	PI (kW)	TC (kW)	PI (kW)	TC (kW)	PI (kW)	TC (kW)	PI (kW)	TC (kW)	PI (kW)	TC (kW)	PI (kW)
15.0	13.7	64.0	64.0	14.2	57.6	12.2	51.2	10.3	44.8	8.57	38.4	6.99	32.0	5.56	25.6	4.27	19.2	3.13
13.0	11.8	64.0	64.0	14.7	57.6	12.6	51.2	10.7	44.8	8.86	38.4	7.21	32.0	5.72	25.6	4.39	19.2	3.21
11.0	9.8	64.0	64.0	15.3	57.6	13.1	51.2	11.1	44.8	9.19	38.4	7.47	32.0	5.91	25.6	4.52	19.2	3.30
9.0	7.9	64.0	64.0	15.9	57.6	13.6	51.2	11.5	44.8	9.52	38.4	7.72	32.0	6.10	25.6	4.66	19.2	3.38
7.0	6.0	64.0	64.0	16.6	57.6	14.2	51.2	11.9	44.8	9.88	38.4	8.00	32.0	6.31	25.6	4.80	19.2	3.48
5.0	4.1	61.7	61.7	16.5	55.5	14.1	49.4	11.8	43.2	9.80	37.0	7.94	30.9	6.26	24.7	4.77	18.5	3.45
3.0	2.2	59.4	59.4	16.3	53.5	14.0	47.5	11.8	41.6	9.73	35.6	7.88	29.7	6.22	23.8	4.73	17.8	3.43
0.0	-0.7	55.9	55.9	16.2	50.3	13.8	44.7	11.6	39.1	9.61	33.6	7.79	28.0	6.14	22.4	4.67	16.8	3.39
-3.0	-3.7	52.3	52.3	16.0	47.1	13.6	41.8	11.5	36.6	9.49	31.4	7.69	26.1	6.07	20.9	4.62	15.7	3.34
-5.0	-5.6	50.0	50.0	15.8	45.0	13.5	40.0	11.4	35.0	9.42	30.0	7.63	25.0	6.02	20.0	4.58	15.0	3.32
-7.0	-7.6	47.6	47.6	15.7	42.8	13.4	38.1	11.3	33.3	9.34	28.6	7.57	23.8	5.97	19.0	4.54	14.3	3.29
-10	-10.5	44.1	44.1	15.5	39.7	13.2	35.3	11.1	30.9	9.22	26.5	7.47	22.0	5.89	17.6	4.49	13.2	3.25
-14.5	-15.0	38.7	38.7	15.2	34.8	13.0	30.9	10.9	27.1	9.05	23.2	7.33	19.3	5.78	15.5	4.40	11.6	3.19

TC : Total Capacity PI : Power Input
 Indoor air temperature conditions : 20.0 °C dry-bulb



MMY-AP2416HT8P (24HP, 67kW system)

Cooling			Compressor + Outdoor Fan Power consumption (kW)															
Outdoor Unit Dry-Bulb (°C)		Outdoor Unit 100% Cooling Capacity (kW)	100%		90%		80%		70%		60%		50%		40%		30%	
			TC (kW)	PI (kW)	TC (kW)	PI (kW)	TC (kW)	PI (kW)	TC (kW)	PI (kW)	TC (kW)	PI (kW)	TC (kW)	PI (kW)	TC (kW)	PI (kW)	TC (kW)	PI (kW)
40		62.3	62.3	20.3	56.1	16.8	49.9	13.6	43.6	10.8	37.4	8.30	31.2	6.18	24.9	4.42	18.7	3.01
39		63.4	63.4	20.0	57.0	16.5	50.7	13.4	44.3	10.6	38.0	8.17	31.7	6.09	25.3	4.35	19.0	2.97
37		65.2	65.2	19.4	58.7	16.0	52.2	13.0	45.7	10.3	39.1	7.93	32.6	5.90	26.1	4.22	19.6	2.88
35		67.0	67.0	18.8	60.3	15.5	53.6	12.6	46.9	9.97	40.2	7.68	33.5	5.72	26.8	4.09	20.1	2.79
33		67.0	67.0	17.4	60.3	14.4	53.6	11.7	46.9	9.25	40.2	7.14	33.5	5.33	26.8	3.82	20.1	2.62
31		67.0	67.0	16.2	60.3	13.4	53.6	10.9	46.9	8.61	40.2	6.65	33.5	4.98	26.8	3.58	20.1	2.46
30		67.0	67.0	15.6	60.3	12.9	53.6	10.5	46.9	8.32	40.2	6.43	33.5	4.81	26.8	3.47	20.1	2.39
29		67.0	67.0	15.1	60.3	12.5	53.6	10.1	46.9	8.04	40.2	6.22	33.5	4.66	26.8	3.36	20.1	2.32
27		67.0	67.0	14.1	60.3	11.6	53.6	9.45	46.9	7.51	40.2	5.82	33.5	4.36	26.8	3.16	20.1	2.19
25		67.0	67.0	13.1	60.3	10.9	53.6	8.84	46.9	7.03	40.2	5.45	33.5	4.10	26.8	2.97	20.1	2.07
23		67.0	67.0	12.5	60.3	10.4	53.6	8.45	46.9	6.73	40.2	5.22	33.5	3.93	26.8	2.85	20.1	1.99
21		67.0	67.0	12.3	60.3	10.2	53.6	8.28	46.9	6.60	40.2	5.12	33.5	3.86	26.8	2.81	20.1	1.96
20		67.0	67.0	12.2	60.3	10.1	53.6	8.20	46.9	6.54	40.2	5.08	33.5	3.83	26.8	2.79	20.1	1.95
19		67.0	67.0	12.0	60.3	9.99	53.6	8.13	46.9	6.48	40.2	5.04	33.5	3.80	26.8	2.77	20.1	1.94
17		67.0	67.0	11.9	60.3	9.83	53.6	8.00	46.9	6.38	40.2	4.96	33.5	3.75	26.8	2.73	20.1	1.94
15		67.0	67.0	11.7	60.3	9.69	53.6	7.90	46.9	6.30	40.2	4.90	33.5	3.70	26.8	2.70	20.1	1.94

TC : Total Capacity PI : Power Input
 Indoor air temperature conditions : 27.0 °C dry-bulb / 19.0 °C wet-bulb

Heating			Compressor + Outdoor Fan Power consumption (kW)															
Outdoor Unit		Outdoor Unit 100% Cooling Capacity (kW)	100%		90%		80%		70%		60%		50%		40%		30%	
Dry-Bulb (°C)	Wet-Bulb (°C)		TC (kW)	PI (kW)	TC (kW)	PI (kW)	TC (kW)	PI (kW)	TC (kW)	PI (kW)	TC (kW)	PI (kW)	TC (kW)	PI (kW)	TC (kW)	PI (kW)	TC (kW)	PI (kW)
15.0	13.7	75.0	75.0	15.8	67.5	13.5	60.0	11.3	52.5	9.42	45.0	7.66	37.5	6.09	30.0	4.70	22.5	3.49
13.0	11.8	75.0	75.0	16.4	67.5	14.0	60.0	11.8	52.5	9.74	45.0	7.91	37.5	6.28	30.0	4.83	22.5	3.57
11.0	9.8	75.0	75.0	17.0	67.5	14.5	60.0	12.2	52.5	10.1	45.0	8.19	37.5	6.48	30.0	4.97	22.5	3.66
9.0	7.9	75.0	75.0	17.7	67.5	15.1	60.0	12.7	52.5	10.5	45.0	8.47	37.5	6.69	30.0	5.12	22.5	3.76
7.0	6.0	75.0	75.0	18.5	67.5	15.7	60.0	13.2	52.5	10.9	45.0	8.78	37.5	6.92	30.0	5.28	22.5	3.86
5.0	4.1	72.3	72.3	18.3	65.1	15.6	57.9	13.1	50.6	10.8	43.4	8.72	36.2	6.86	28.9	5.24	21.7	3.83
3.0	2.2	69.6	69.6	18.2	62.7	15.5	55.7	13.0	48.7	10.7	41.8	8.65	34.8	6.81	27.9	5.19	20.9	3.80
0.0	-0.7	65.5	65.5	18.0	59.0	15.3	52.4	12.8	45.9	10.6	39.3	8.55	32.8	6.73	26.2	5.13	19.7	3.75
-3.0	-3.7	61.3	61.3	17.8	55.2	15.1	49.0	12.7	42.9	10.4	36.8	8.44	30.6	6.65	24.5	5.07	18.4	3.71
-5.0	-5.6	58.6	58.6	17.6	52.7	15.0	46.9	12.6	41.0	10.4	35.2	8.38	29.3	6.60	23.4	5.03	17.6	3.68
-7.0	-7.6	55.8	55.8	17.5	50.2	14.9	44.6	12.5	39.0	10.3	33.5	8.30	27.9	6.54	22.3	4.99	16.7	3.65
-10	-10.5	51.7	51.7	17.3	46.5	14.7	41.3	12.3	36.2	10.2	31.0	8.20	25.8	6.46	20.7	4.93	15.5	3.60
-14.5	-15.0	45.3	45.3	16.9	40.8	14.4	36.3	12.1	31.7	9.96	27.2	8.04	22.7	6.34	18.1	4.83	13.6	3.53

TC : Total Capacity PI : Power Input
 Indoor air temperature conditions : 20.0 °C dry-bulb



MMY-AP2616HT8P (26HP, 73.5kW system)

Cooling			Compressor + Outdoor Fan Power consumption (kW)															
Outdoor Unit Dry-Bulb (°C)		Outdoor Unit 100% Cooling Capacity (kW)	100%		90%		80%		70%		60%		50%		40%		30%	
			TC (kW)	PI (kW)	TC (kW)	PI (kW)	TC (kW)	PI (kW)	TC (kW)	PI (kW)	TC (kW)	PI (kW)	TC (kW)	PI (kW)	TC (kW)	PI (kW)	TC (kW)	PI (kW)
40		68.4	68.4	22.6	61.6	18.7	54.7	15.1	47.9	12.0	41.0	9.23	34.2	6.88	27.4	4.93	20.5	3.38
39		69.5	69.5	22.3	62.5	18.4	55.6	14.9	48.6	11.8	41.7	9.09	34.7	6.78	27.8	4.86	20.8	3.33
37		71.6	71.6	21.6	64.4	17.8	57.3	14.4	50.1	11.4	42.9	8.82	35.8	6.58	28.6	4.71	21.5	3.22
35		73.5	73.5	20.9	66.2	17.3	58.8	14.0	51.5	11.1	44.1	8.54	36.8	6.37	29.4	4.56	22.1	3.12
33		73.5	73.5	19.4	66.2	16.0	58.8	13.0	51.5	10.3	44.1	7.94	36.8	5.94	29.4	4.27	22.1	2.94
31		73.5	73.5	18.0	66.2	14.9	58.8	12.1	51.5	9.58	44.1	7.41	36.8	5.55	29.4	4.00	22.1	2.76
30		73.5	73.5	17.3	66.2	14.3	58.8	11.6	51.5	9.25	44.1	7.16	36.8	5.36	29.4	3.87	22.1	2.68
29		73.5	73.5	16.7	66.2	13.9	58.8	11.2	51.5	8.94	44.1	6.92	36.8	5.19	29.4	3.75	22.1	2.61
27		73.5	73.5	15.6	66.2	12.9	58.8	10.5	51.5	8.36	44.1	6.48	36.8	4.87	29.4	3.53	22.1	2.46
25		73.5	73.5	14.6	66.2	12.1	58.8	9.82	51.5	7.82	44.1	6.07	36.8	4.57	29.4	3.32	22.1	2.32
23		73.5	73.5	13.9	66.2	11.5	58.8	9.40	51.5	7.49	44.1	5.81	36.8	4.38	29.4	3.19	22.1	2.24
21		73.5	73.5	13.6	66.2	11.3	58.8	9.21	51.5	7.34	44.1	5.70	36.8	4.30	29.4	3.14	22.1	2.21
20		73.5	73.5	13.5	66.2	11.2	58.8	9.12	51.5	7.27	44.1	5.66	36.8	4.27	29.4	3.12	22.1	2.19
19		73.5	73.5	13.4	66.2	11.1	58.8	9.04	51.5	7.21	44.1	5.61	36.8	4.24	29.4	3.10	22.1	2.18
17		73.5	73.5	13.2	66.2	10.9	58.8	8.90	51.5	7.10	44.1	5.53	36.8	4.18	29.4	3.06	22.1	2.17
15		73.5	73.5	13.0	66.2	10.8	58.8	8.78	51.5	7.01	44.1	5.46	36.8	4.13	29.4	3.03	22.1	2.16

TC : Total Capacity PI : Power Input
 Indoor air temperature conditions : 27.0 °C dry-bulb / 19.0 °C wet-bulb

Heating			Compressor + Outdoor Fan Power consumption (kW)															
Outdoor Unit Dry-Bulb (°C) / Wet-Bulb (°C)		Outdoor Unit 100% Cooling Capacity (kW)	100%		90%		80%		70%		60%		50%		40%		30%	
			TC (kW)	PI (kW)	TC (kW)	PI (kW)	TC (kW)	PI (kW)	TC (kW)	PI (kW)	TC (kW)	PI (kW)	TC (kW)	PI (kW)	TC (kW)	PI (kW)	TC (kW)	PI (kW)
15.0	13.7	82.5	82.5	16.8	74.3	14.3	66.0	12.0	57.8	9.93	49.5	8.12	41.3	6.54	33.0	5.20	24.8	4.10
13.0	11.8	82.5	82.5	17.5	74.3	14.8	66.0	12.4	57.8	10.3	49.5	8.37	41.3	6.72	33.0	5.32	24.8	4.17
11.0	9.8	82.5	82.5	18.2	74.3	15.4	66.0	12.9	57.8	10.6	49.5	8.65	41.3	6.92	33.0	5.45	24.8	4.24
9.0	7.9	82.5	82.5	19.0	74.3	16.1	66.0	13.4	57.8	11.0	49.5	8.95	41.3	7.13	33.0	5.59	24.8	4.32
7.0	6.0	82.5	82.5	19.8	74.3	16.8	66.0	14.0	57.8	11.5	49.5	9.27	41.3	7.36	33.0	5.74	24.8	4.41
5.0	4.1	79.7	79.7	19.7	71.7	16.6	63.8	13.9	55.8	11.4	47.8	9.21	39.9	7.31	31.9	5.70	23.9	4.38
3.0	2.2	76.9	76.9	19.6	69.2	16.5	61.5	13.8	53.8	11.3	46.2	9.15	38.5	7.26	30.8	5.66	23.1	4.35
0.0	-0.7	72.7	72.7	19.4	65.4	16.4	58.1	13.6	50.9	11.2	43.6	9.05	36.3	7.18	29.1	5.60	21.8	4.31
-3.0	-3.7	68.3	68.3	19.2	61.4	16.2	54.6	13.5	47.8	11.1	41.0	8.96	34.1	7.11	27.3	5.54	20.5	4.26
-5.0	-5.6	65.5	65.5	19.0	58.9	16.1	52.4	13.4	45.8	11.0	39.3	8.89	32.7	7.06	26.2	5.51	19.6	4.23
-7.0	-7.6	62.5	62.5	18.9	56.3	16.0	50.0	13.3	43.8	10.9	37.5	8.83	31.3	7.01	25.0	5.47	18.8	4.20
-10	-10.5	58.3	58.3	18.7	52.4	15.8	46.6	13.2	40.8	10.8	35.0	8.74	29.1	6.93	23.3	5.41	17.5	4.16
-14.5	-15.0	51.7	51.7	18.4	46.5	15.5	41.3	12.9	36.2	10.6	31.0	8.59	25.8	6.82	20.7	5.32	15.5	4.09

TC : Total Capacity PI : Power Input
 Indoor air temperature conditions : 20.0 °C dry-bulb



MMY-AP2816HT8P (28HP, 78.5kW system)

Cooling			Compressor + Outdoor Fan Power consumption (kW)															
Outdoor Unit Dry-Bulb (°C)		Outdoor Unit 100% Cooling Capacity (kW)	100%		90%		80%		70%		60%		50%		40%		30%	
			TC (kW)	PI (kW)	TC (kW)	PI (kW)	TC (kW)	PI (kW)	TC (kW)	PI (kW)	TC (kW)	PI (kW)	TC (kW)	PI (kW)	TC (kW)	PI (kW)	TC (kW)	PI (kW)
40		73.1	73.1	24.9	65.7	20.5	58.4	16.5	51.1	13.1	43.8	10.0	36.5	7.40	29.2	5.24	21.9	3.52
39		74.2	74.2	24.5	66.8	20.2	59.4	16.3	52.0	12.9	44.5	9.86	37.1	7.29	29.7	5.16	22.3	3.47
37		76.4	76.4	23.7	68.8	19.6	61.2	15.8	53.5	12.5	45.9	9.56	38.2	7.07	30.6	5.00	22.9	3.36
35		78.5	78.5	23.0	70.7	19.0	62.8	15.3	55.0	12.1	47.1	9.26	39.3	6.85	31.4	4.85	23.6	3.26
33		78.5	78.5	21.3	70.7	17.6	62.8	14.2	55.0	11.2	47.1	8.60	39.3	6.37	31.4	4.53	23.6	3.06
31		78.5	78.5	19.8	70.7	16.3	62.8	13.2	55.0	10.4	47.1	8.01	39.3	5.95	31.4	4.24	23.6	2.88
30		78.5	78.5	19.1	70.7	15.7	62.8	12.7	55.0	10.1	47.1	7.74	39.3	5.75	31.4	4.10	23.6	2.79
29		78.5	78.5	18.4	70.7	15.2	62.8	12.3	55.0	9.72	47.1	7.48	39.3	5.56	31.4	3.97	23.6	2.71
27		78.5	78.5	17.2	70.7	14.2	62.8	11.5	55.0	9.08	47.1	6.99	39.3	5.21	31.4	3.73	23.6	2.55
25		78.5	78.5	16.0	70.7	13.2	62.8	10.7	55.0	8.49	47.1	6.55	39.3	4.89	31.4	3.50	23.6	2.40
23		78.5	78.5	15.3	70.7	12.6	62.8	10.2	55.0	8.13	47.1	6.27	39.3	4.68	31.4	3.37	23.6	2.32
21		78.5	78.5	15.0	70.7	12.4	62.8	10.0	55.0	7.96	47.1	6.15	39.3	4.60	31.4	3.31	23.6	2.28
20		78.5	78.5	14.8	70.7	12.3	62.8	9.94	55.0	7.89	47.1	6.10	39.3	4.56	31.4	3.29	23.6	2.27
19		78.5	78.5	14.7	70.7	12.1	62.8	9.85	55.0	7.82	47.1	6.05	39.3	4.53	31.4	3.26	23.6	2.26
17		78.5	78.5	14.4	70.7	11.9	62.8	9.70	55.0	7.70	47.1	5.96	39.3	4.46	31.4	3.22	23.6	2.24
15		78.5	78.5	14.2	70.7	11.8	62.8	9.56	55.0	7.60	47.1	5.88	39.3	4.41	31.4	3.19	23.6	2.23

TC : Total Capacity PI : Power Input
 Indoor air temperature conditions : 27.0 °C dry-bulb / 19.0 °C wet-bulb

Heating			Compressor + Outdoor Fan Power consumption (kW)															
Outdoor Unit		Outdoor Unit 100% Cooling Capacity (kW)	100%		90%		80%		70%		60%		50%		40%		30%	
Dry-Bulb (°C)	Wet-Bulb (°C)		TC (kW)	PI (kW)	TC (kW)	PI (kW)	TC (kW)	PI (kW)	TC (kW)	PI (kW)	TC (kW)	PI (kW)	TC (kW)	PI (kW)	TC (kW)	PI (kW)	TC (kW)	PI (kW)
15.0	13.7	87.5	87.5	18.4	78.8	15.6	70.0	13.0	61.3	10.8	52.5	8.79	43.8	7.06	35.0	5.59	26.3	4.39
13.0	11.8	87.5	87.5	19.1	78.8	16.2	70.0	13.5	61.3	11.2	52.5	9.07	43.8	7.25	35.0	5.72	26.3	4.46
11.0	9.8	87.5	87.5	19.9	78.8	16.9	70.0	14.1	61.3	11.6	52.5	9.38	43.8	7.48	35.0	5.87	26.3	4.55
9.0	7.9	87.5	87.5	20.8	78.8	17.6	70.0	14.6	61.3	12.0	52.5	9.71	43.8	7.71	35.0	6.02	26.3	4.63
7.0	6.0	87.5	87.5	21.7	78.8	18.3	70.0	15.2	61.3	12.5	52.5	10.1	43.8	7.96	35.0	6.18	26.3	4.73
5.0	4.1	84.4	84.4	21.6	75.9	18.2	67.5	15.1	59.1	12.4	50.6	10.0	42.2	7.90	33.7	6.13	25.3	4.69
3.0	2.2	81.2	81.2	21.4	73.1	18.0	65.0	15.0	56.9	12.3	48.7	9.91	40.6	7.83	32.5	6.08	24.4	4.66
0.0	-0.7	76.4	76.4	21.2	68.8	17.8	61.2	14.8	53.5	12.2	45.9	9.79	38.2	7.74	30.6	6.01	22.9	4.60
-3.0	-3.7	71.5	71.5	20.9	64.4	17.6	57.2	14.7	50.1	12.0	42.9	9.67	35.8	7.65	28.6	5.94	21.5	4.54
-5.0	-5.6	68.4	68.4	20.7	61.5	17.5	54.7	14.5	47.9	11.9	41.0	9.59	34.2	7.59	27.3	5.89	20.5	4.51
-7.0	-7.6	65.1	65.1	20.6	58.6	17.3	52.1	14.4	45.5	11.8	39.0	9.51	32.5	7.52	26.0	5.84	19.5	4.47
-10	-10.5	60.3	60.3	20.3	54.3	17.1	48.2	14.2	42.2	11.7	36.2	9.40	30.1	7.43	24.1	5.77	18.1	4.42
-14.5	-15.0	52.9	52.9	19.9	47.6	16.8	42.3	14.0	37.0	11.4	31.7	9.21	26.4	7.29	21.1	5.66	15.9	4.33

TC : Total Capacity PI : Power Input
 Indoor air temperature conditions : 20.0 °C dry-bulb



MMY-AP3016HT8P (30HP, 85kW system)

Cooling			Compressor + Outdoor Fan Power consumption (kW)															
Outdoor Unit Dry-Bulb (°C)		Outdoor Unit 100% Cooling Capacity (kW)	100%		90%		80%		70%		60%		50%		40%		30%	
			TC (kW)	PI (kW)	TC (kW)	PI (kW)	TC (kW)	PI (kW)	TC (kW)	PI (kW)	TC (kW)	PI (kW)	TC (kW)	PI (kW)	TC (kW)	PI (kW)	TC (kW)	PI (kW)
40		79.1	79.1	27.1	71.2	22.3	63.3	18.1	55.4	14.3	47.5	10.9	39.5	8.10	31.6	5.75	23.7	3.89
39		80.4	80.4	26.7	72.3	22.0	64.3	17.8	56.3	14.0	48.2	10.8	40.2	7.98	32.1	5.67	24.1	3.83
37		82.8	82.8	25.9	74.5	21.3	66.2	17.3	57.9	13.6	49.7	10.5	41.4	7.74	33.1	5.50	24.8	3.71
35		85.0	85.0	25.1	76.5	20.7	68.0	16.7	59.5	13.2	51.0	10.1	42.5	7.50	34.0	5.32	25.5	3.60
33		85.0	85.0	23.2	76.5	19.2	68.0	15.5	59.5	12.2	51.0	9.41	42.5	6.98	34.0	4.97	25.5	3.38
31		85.0	85.0	21.6	76.5	17.8	68.0	14.4	59.5	11.4	51.0	8.76	42.5	6.52	34.0	4.66	25.5	3.18
30		85.0	85.0	20.8	76.5	17.2	68.0	13.9	59.5	11.0	51.0	8.47	42.5	6.30	34.0	4.51	25.5	3.08
29		85.0	85.0	20.1	76.5	16.6	68.0	13.4	59.5	10.6	51.0	8.18	42.5	6.10	34.0	4.37	25.5	2.99
27		85.0	85.0	18.7	76.5	15.5	68.0	12.5	59.5	9.92	51.0	7.65	42.5	5.71	34.0	4.10	25.5	2.82
25		85.0	85.0	17.5	76.5	14.4	68.0	11.7	59.5	9.28	51.0	7.17	42.5	5.36	34.0	3.85	25.5	2.66
23		85.0	85.0	16.7	76.5	13.8	68.0	11.2	59.5	8.88	51.0	6.86	42.5	5.14	34.0	3.70	25.5	2.56
21		85.0	85.0	16.3	76.5	13.5	68.0	11.0	59.5	8.70	51.0	6.73	42.5	5.04	34.0	3.64	25.5	2.53
20		85.0	85.0	16.2	76.5	13.4	68.0	10.9	59.5	8.63	51.0	6.67	42.5	5.00	34.0	3.62	25.5	2.51
19		85.0	85.0	16.0	76.5	13.3	68.0	10.8	59.5	8.55	51.0	6.62	42.5	4.96	34.0	3.59	25.5	2.50
17		85.0	85.0	15.8	76.5	13.0	68.0	10.6	59.5	8.42	51.0	6.52	42.5	4.90	34.0	3.55	25.5	2.47
15		85.0	85.0	15.5	76.5	12.9	68.0	10.4	59.5	8.31	51.0	6.44	42.5	4.84	34.0	3.51	25.5	2.45

TC : Total Capacity PI : Power Input
 Indoor air temperature conditions : 27.0 °C dry-bulb / 19.0 °C wet-bulb

Heating			Compressor + Outdoor Fan Power consumption (kW)															
Outdoor Unit		Outdoor Unit 100% Cooling Capacity (kW)	100%		90%		80%		70%		60%		50%		40%		30%	
Dry-Bulb (°C)	Wet-Bulb (°C)		TC (kW)	PI (kW)	TC (kW)	PI (kW)	TC (kW)	PI (kW)	TC (kW)	PI (kW)	TC (kW)	PI (kW)	TC (kW)	PI (kW)	TC (kW)	PI (kW)	TC (kW)	PI (kW)
15.0	13.7	95.0	95.0	19.4	85.5	16.4	76.0	13.7	66.5	11.3	57.0	9.25	47.5	7.51	38.0	6.09	28.5	4.99
13.0	11.8	95.0	95.0	20.2	85.5	17.0	76.0	14.2	66.5	11.7	57.0	9.53	47.5	7.70	38.0	6.21	28.5	5.05
11.0	9.8	95.0	95.0	21.1	85.5	17.8	76.0	14.8	66.5	12.1	57.0	9.85	47.5	7.92	38.0	6.34	28.5	5.12
9.0	7.9	95.0	95.0	22.1	85.5	18.5	76.0	15.4	66.5	12.6	57.0	10.2	47.5	8.15	38.0	6.48	28.5	5.20
7.0	6.0	95.0	95.0	23.1	85.5	19.4	76.0	16.0	66.5	13.1	57.0	10.5	47.5	8.39	38.0	6.64	28.5	5.28
5.0	4.1	91.8	91.8	22.9	82.6	19.2	73.4	15.9	64.2	13.0	55.1	10.5	45.9	8.34	36.7	6.59	27.5	5.24
3.0	2.2	88.5	88.5	22.8	79.7	19.1	70.8	15.8	62.0	12.9	53.1	10.4	44.3	8.28	35.4	6.55	26.6	5.21
0.0	-0.7	83.6	83.6	22.5	75.2	18.9	66.9	15.6	58.5	12.8	50.1	10.3	41.8	8.20	33.4	6.48	25.1	5.15
-3.0	-3.7	78.5	78.5	22.3	70.6	18.7	62.8	15.5	54.9	12.6	47.1	10.2	39.2	8.11	31.4	6.41	23.5	5.10
-5.0	-5.6	75.2	75.2	22.1	67.7	18.6	60.2	15.4	52.7	12.6	45.1	10.1	37.6	8.05	30.1	6.37	22.6	5.06
-7.0	-7.6	71.8	71.8	22.0	64.6	18.4	57.5	15.3	50.3	12.5	43.1	10.0	35.9	7.99	28.7	6.32	21.5	5.03
-10	-10.5	66.9	66.9	21.7	60.2	18.2	53.5	15.1	46.8	12.3	40.1	9.93	33.4	7.90	26.8	6.25	20.1	4.97
-14.5	-15.0	59.2	59.2	21.4	53.3	17.9	47.4	14.8	41.5	12.1	35.5	9.76	29.6	7.77	23.7	6.15	17.8	4.89

TC : Total Capacity PI : Power Input
 Indoor air temperature conditions : 20.0 °C dry-bulb



MMY-AP3216HT8P (32HP, 90kW system)

Cooling			Compressor + Outdoor Fan Power consumption (kW)															
Outdoor Unit Dry-Bulb (°C)		Outdoor Unit 100% Cooling Capacity (kW)	100%		90%		80%		70%		60%		50%		40%		30%	
			TC (kW)	PI (kW)	TC (kW)	PI (kW)	TC (kW)	PI (kW)	TC (kW)	PI (kW)	TC (kW)	PI (kW)	TC (kW)	PI (kW)	TC (kW)	PI (kW)	TC (kW)	PI (kW)
40		83.8	83.8	29.4	75.4	24.2	67.0	19.5	58.6	15.3	50.3	11.7	41.9	8.62	33.5	6.06	25.1	4.03
39		85.1	85.1	28.9	76.6	23.8	68.1	19.2	59.6	15.1	51.1	11.5	42.5	8.49	34.0	5.97	25.5	3.97
37		87.6	87.6	28.1	78.9	23.1	70.1	18.6	61.3	14.6	52.6	11.2	43.8	8.24	35.1	5.79	26.3	3.85
35		90.0	90.0	27.2	81.0	22.4	72.0	18.0	63.0	14.2	54.0	10.8	45.0	7.98	36.0	5.61	27.0	3.73
33		90.0	90.0	25.2	81.0	20.7	72.0	16.7	63.0	13.2	54.0	10.1	45.0	7.42	36.0	5.23	27.0	3.50
31		90.0	90.0	23.3	81.0	19.2	72.0	15.5	63.0	12.2	54.0	9.37	45.0	6.92	36.0	4.90	27.0	3.29
30		90.0	90.0	22.5	81.0	18.5	72.0	15.0	63.0	11.8	54.0	9.05	45.0	6.69	36.0	4.74	27.0	3.19
29		90.0	90.0	21.7	81.0	17.9	72.0	14.5	63.0	11.4	54.0	8.74	45.0	6.47	36.0	4.59	27.0	3.09
27		90.0	90.0	20.3	81.0	16.7	72.0	13.5	63.0	10.6	54.0	8.17	45.0	6.06	36.0	4.30	27.0	2.91
25		90.0	90.0	18.9	81.0	15.6	72.0	12.6	63.0	9.96	54.0	7.65	45.0	5.68	36.0	4.04	27.0	2.74
23		90.0	90.0	18.1	81.0	14.9	72.0	12.0	63.0	9.52	54.0	7.32	45.0	5.44	36.0	3.88	27.0	2.64
21		90.0	90.0	17.7	81.0	14.6	72.0	11.8	63.0	9.33	54.0	7.18	45.0	5.34	36.0	3.81	27.0	2.60
20		90.0	90.0	17.5	81.0	14.4	72.0	11.7	63.0	9.24	54.0	7.11	45.0	5.29	36.0	3.79	27.0	2.59
19		90.0	90.0	17.3	81.0	14.3	72.0	11.6	63.0	9.16	54.0	7.05	45.0	5.25	36.0	3.76	27.0	2.57
17		90.0	90.0	17.0	81.0	14.1	72.0	11.4	63.0	9.02	54.0	6.95	45.0	5.18	36.0	3.71	27.0	2.54
15		90.0	90.0	16.8	81.0	13.9	72.0	11.2	63.0	8.90	54.0	6.86	45.0	5.11	36.0	3.67	27.0	2.52

TC : Total Capacity PI : Power Input
 Indoor air temperature conditions : 27.0 °C dry-bulb / 19.0 °C wet-bulb

Heating			Compressor + Outdoor Fan Power consumption (kW)															
Outdoor Unit		Outdoor Unit 100% Cooling Capacity (kW)	100%		90%		80%		70%		60%		50%		40%		30%	
Dry-Bulb (°C)	Wet-Bulb (°C)		TC (kW)	PI (kW)	TC (kW)	PI (kW)	TC (kW)	PI (kW)	TC (kW)	PI (kW)	TC (kW)	PI (kW)	TC (kW)	PI (kW)	TC (kW)	PI (kW)	TC (kW)	PI (kW)
15.0	13.7	100.0	100.0	21.0	90.0	17.7	80.0	14.7	70.0	12.2	60.0	9.92	50.0	8.03	40.0	6.48	30.0	5.28
13.0	11.8	100.0	100.0	21.8	90.0	18.4	80.0	15.3	70.0	12.6	60.0	10.2	50.0	8.23	40.0	6.61	30.0	5.35
11.0	9.8	100.0	100.0	22.8	90.0	19.2	80.0	15.9	70.0	13.1	60.0	10.6	50.0	8.47	40.0	6.76	30.0	5.43
9.0	7.9	100.0	100.0	23.9	90.0	20.0	80.0	16.6	70.0	13.6	60.0	10.9	50.0	8.72	40.0	6.91	30.0	5.51
7.0	6.0	100.0	100.0	25.0	90.0	20.9	80.0	17.3	70.0	14.1	60.0	11.3	50.0	8.99	40.0	7.08	30.0	5.60
5.0	4.1	96.4	96.4	24.8	86.8	20.8	77.1	17.2	67.5	14.0	57.9	11.2	48.2	8.93	38.6	7.03	28.9	5.56
3.0	2.2	92.8	92.8	24.6	83.6	20.6	74.3	17.0	65.0	13.9	55.7	11.2	46.4	8.86	37.1	6.97	27.9	5.51
0.0	-0.7	87.4	87.4	24.3	78.6	20.4	69.9	16.8	61.2	13.7	52.4	11.0	43.7	8.75	34.9	6.89	26.2	5.45
-3.0	-3.7	81.7	81.7	24.0	73.5	20.1	65.4	16.6	57.2	13.6	49.0	10.9	40.9	8.65	32.7	6.81	24.5	5.38
-5.0	-5.6	78.1	78.1	23.8	70.3	20.0	62.5	16.5	54.7	13.5	46.9	10.8	39.1	8.58	31.3	6.75	23.4	5.34
-7.0	-7.6	74.4	74.4	23.6	66.9	19.8	59.5	16.4	52.1	13.3	44.6	10.7	37.2	8.50	29.7	6.70	22.3	5.29
-10	-10.5	68.9	68.9	23.3	62.0	19.6	55.1	16.2	48.2	13.2	41.3	10.6	34.5	8.40	27.6	6.61	20.7	5.23
-14.5	-15.0	60.4	60.4	22.9	54.4	19.2	48.3	15.9	42.3	12.9	36.3	10.4	30.2	8.24	24.2	6.49	18.1	5.13

TC : Total Capacity PI : Power Input
 Indoor air temperature conditions : 20.0 °C dry-bulb



MMY-AP3416HT8P (34HP, 95.4kW system)

Cooling			Compressor + Outdoor Fan Power consumption (kW)															
Outdoor Unit Dry-Bulb (°C)		Outdoor Unit 100% Cooling Capacity (kW)	100%		90%		80%		70%		60%		50%		40%		30%	
			TC (kW)	PI (kW)	TC (kW)	PI (kW)	TC (kW)	PI (kW)	TC (kW)	PI (kW)	TC (kW)	PI (kW)	TC (kW)	PI (kW)	TC (kW)	PI (kW)	TC (kW)	PI (kW)
40		88.8	88.8	29.8	79.9	24.7	71.0	20.1	62.1	16.0	53.3	12.4	44.4	9.26	35.5	6.63	26.6	4.49
39		90.2	90.2	29.4	81.2	24.3	72.2	19.8	63.1	15.8	54.1	12.2	45.1	9.12	36.1	6.53	27.1	4.43
37		92.9	92.9	28.5	83.6	23.6	74.3	19.2	65.0	15.3	55.7	11.8	46.4	8.85	37.2	6.33	27.9	4.29
35		95.4	95.4	27.6	85.9	22.9	76.3	18.6	66.8	14.8	57.2	11.5	47.7	8.57	38.2	6.13	28.6	4.16
33		95.4	95.4	25.6	85.9	21.2	76.3	17.3	66.8	13.8	57.2	10.7	47.7	7.99	38.2	5.73	28.6	3.90
31		95.4	95.4	23.8	85.9	19.7	76.3	16.1	66.8	12.8	57.2	9.95	47.7	7.46	38.2	5.37	28.6	3.67
30		95.4	95.4	22.9	85.9	19.0	76.3	15.5	66.8	12.4	57.2	9.61	47.7	7.22	38.2	5.20	28.6	3.56
29		95.4	95.4	22.1	85.9	18.4	76.3	15.0	66.8	12.0	57.2	9.30	47.7	6.99	38.2	5.04	28.6	3.45
27		95.4	95.4	20.7	85.9	17.2	76.3	14.0	66.8	11.2	57.2	8.70	47.7	6.55	38.2	4.73	28.6	3.26
25		95.4	95.4	19.3	85.9	16.1	76.3	13.1	66.8	10.5	57.2	8.15	47.7	6.15	38.2	4.45	28.6	3.07
23		95.4	95.4	18.5	85.9	15.4	76.3	12.5	66.8	10.0	57.2	7.81	47.7	5.90	38.2	4.28	28.6	2.96
21		95.4	95.4	18.1	85.9	15.0	76.3	12.3	66.8	9.84	57.2	7.67	47.7	5.79	38.2	4.21	28.6	2.91
20		95.4	95.4	17.9	85.9	14.9	76.3	12.2	66.8	9.75	57.2	7.60	47.7	5.75	38.2	4.18	28.6	2.90
19		95.4	95.4	17.8	85.9	14.8	76.3	12.1	66.8	9.67	57.2	7.54	47.7	5.70	38.2	4.15	28.6	2.88
17		95.4	95.4	17.5	85.9	14.5	76.3	11.9	66.8	9.52	57.2	7.44	47.7	5.63	38.2	4.10	28.6	2.85
15		95.4	95.4	17.2	85.9	14.3	76.3	11.7	66.8	9.40	57.2	7.34	47.7	5.56	38.2	4.05	28.6	2.82

TC : Total Capacity PI : Power Input
 Indoor air temperature conditions : 27.0 °C dry-bulb / 19.0 °C wet-bulb

Heating			Compressor + Outdoor Fan Power consumption (kW)															
Outdoor Unit		Outdoor Unit 100% Cooling Capacity (kW)	100%		90%		80%		70%		60%		50%		40%		30%	
Dry-Bulb (°C)	Wet-Bulb (°C)		TC (kW)	PI (kW)	TC (kW)	PI (kW)	TC (kW)	PI (kW)	TC (kW)	PI (kW)	TC (kW)	PI (kW)	TC (kW)	PI (kW)	TC (kW)	PI (kW)	TC (kW)	PI (kW)
15.0	13.7	106.0	106.0	22.1	95.4	18.8	84.8	15.8	74.2	13.1	63.6	10.7	53.0	8.64	42.4	6.85	31.8	5.36
13.0	11.8	106.0	106.0	23.0	95.4	19.5	84.8	16.4	74.2	13.6	63.6	11.1	53.0	8.88	42.4	7.01	31.8	5.45
11.0	9.8	106.0	106.0	24.0	95.4	20.3	84.8	17.0	74.2	14.1	63.6	11.4	53.0	9.15	42.4	7.18	31.8	5.55
9.0	7.9	106.0	106.0	25.0	95.4	21.2	84.8	17.7	74.2	14.6	63.6	11.8	53.0	9.43	42.4	7.37	31.8	5.66
7.0	6.0	106.0	106.0	26.1	95.4	22.1	84.8	18.4	74.2	15.2	63.6	12.3	53.0	9.73	42.4	7.57	31.8	5.78
5.0	4.1	102.4	102.4	25.9	92.2	21.9	81.9	18.3	71.7	15.1	61.4	12.2	51.2	9.66	41.0	7.52	30.7	5.74
3.0	2.2	98.8	98.8	25.7	88.9	21.8	79.1	18.2	69.2	15.0	59.3	12.1	49.4	9.60	39.5	7.47	29.6	5.70
0.0	-0.7	93.3	93.3	25.5	84.0	21.6	74.7	18.0	65.3	14.8	56.0	12.0	46.7	9.50	37.3	7.39	28.0	5.65
-3.0	-3.7	87.7	87.7	25.2	78.9	21.3	70.1	17.8	61.4	14.6	52.6	11.8	43.8	9.40	35.1	7.31	26.3	5.59
-5.0	-5.6	84.1	84.1	25.0	75.7	21.2	67.3	17.7	58.9	14.5	50.4	11.8	42.0	9.33	33.6	7.26	25.2	5.55
-7.0	-7.6	80.3	80.3	24.9	72.3	21.0	64.2	17.6	56.2	14.4	48.2	11.7	40.1	9.27	32.1	7.21	24.1	5.51
-10	-10.5	74.8	74.8	24.6	67.3	20.8	59.8	17.4	52.4	14.3	44.9	11.6	37.4	9.17	29.9	7.13	22.4	5.45
-14.5	-15.0	66.3	66.3	24.2	59.7	20.5	53.0	17.1	46.4	14.1	39.8	11.4	33.2	9.02	26.5	7.02	19.9	5.36

TC : Total Capacity PI : Power Input
 Indoor air temperature conditions : 20.0 °C dry-bulb



MMY-AP3616HT8P (36HP, 101kW system)

Cooling			Compressor + Outdoor Fan Power consumption (kW)															
Outdoor Unit		Outdoor Unit 100% Cooling Capacity (kW)	100%		90%		80%		70%		60%		50%		40%		30%	
Dry-Bulb (°C)	TC		PI	TC	PI	TC	PI	TC	PI	TC	PI	TC	PI	TC	PI	TC	PI	
	(kW)		(kW)	(kW)	(kW)	(kW)	(kW)	(kW)	(kW)	(kW)	(kW)	(kW)	(kW)	(kW)	(kW)	(kW)	(kW)	(kW)
40		94.0	94.0	33.9	84.6	27.8	75.2	22.3	65.8	17.4	56.4	13.2	47.0	9.71	37.6	6.84	28.2	4.64
39		95.5	95.5	33.4	85.9	27.3	76.4	21.9	66.8	17.2	57.3	13.0	47.7	9.56	38.2	6.74	28.6	4.57
37		98.3	98.3	32.4	88.5	26.5	78.7	21.3	68.8	16.6	59.0	12.6	49.2	9.27	39.3	6.54	29.5	4.43
35		101.0	101.0	31.5	90.9	25.7	80.8	20.6	70.7	16.1	60.6	12.2	50.5	8.98	40.4	6.33	30.3	4.29
33		101.0	101.0	29.0	90.9	23.8	80.8	19.1	70.7	14.9	60.6	11.4	50.5	8.36	40.4	5.91	30.3	4.03
31		101.0	101.0	26.9	90.9	22.0	80.8	17.7	70.7	13.9	60.6	10.57	50.5	7.79	40.4	5.53	30.3	3.80
30		101.0	101.0	25.9	90.9	21.2	80.8	17.1	70.7	13.4	60.6	10.21	50.5	7.53	40.4	5.36	30.3	3.69
29		101.0	101.0	25.0	90.9	20.5	80.8	16.5	70.7	12.9	60.6	9.86	50.5	7.28	40.4	5.19	30.3	3.58
27		101.0	101.0	23.3	90.9	19.1	80.8	15.4	70.7	12.1	60.6	9.21	50.5	6.82	40.4	4.87	30.3	3.38
25		101.0	101.0	21.7	90.9	17.8	80.8	14.3	70.7	11.3	60.6	8.62	50.5	6.39	40.4	4.58	30.3	3.19
23		101.0	101.0	20.7	90.9	17.0	80.8	13.7	70.7	10.8	60.6	8.25	50.5	6.13	40.4	4.40	30.3	3.07
21		101.0	101.0	20.3	90.9	16.6	80.8	13.4	70.7	10.55	60.6	8.09	50.5	6.01	40.4	4.33	30.3	3.03
20		101.0	101.0	20.1	90.9	16.5	80.8	13.3	70.7	10.45	60.6	8.01	50.5	5.96	40.4	4.30	30.3	3.02
19		101.0	101.0	19.9	90.9	16.3	80.8	13.1	70.7	10.36	60.6	7.95	50.5	5.92	40.4	4.27	30.3	3.00
17		101.0	101.0	19.5	90.9	16.0	80.8	12.9	70.7	10.19	60.6	7.83	50.5	5.83	40.4	4.21	30.3	2.97
15		101.0	101.0	19.2	90.9	15.8	80.8	12.7	70.7	10.05	60.6	7.72	50.5	5.76	40.4	4.17	30.3	2.95

TC : Total Capacity PI : Power Input
 Indoor air temperature conditions : 27.0 °C dry-bulb / 19.0 °C wet-bulb

Heating			Compressor + Outdoor Fan Power consumption (kW)															
Outdoor Unit		Outdoor Unit 100% Cooling Capacity (kW)	100%		90%		80%		70%		60%		50%		40%		30%	
Dry-Bulb (°C)	Wet-Bulb (°C)		TC	PI	TC	PI	TC	PI	TC	PI	TC	PI	TC	PI	TC	PI	TC	PI
			(kW)	(kW)	(kW)	(kW)	(kW)	(kW)	(kW)	(kW)	(kW)	(kW)	(kW)	(kW)	(kW)	(kW)	(kW)	(kW)
15.0	13.7	113.0	113.0	24.6	101.7	20.9	90.4	17.6	79.1	14.6	67.8	11.9	56.5	9.50	45.2	7.44	33.9	5.71
13.0	11.8	113.0	113.0	25.6	101.7	21.7	90.4	18.2	79.1	15.1	67.8	12.3	56.5	9.77	45.2	7.62	33.9	5.82
11.0	9.8	113.0	113.0	26.7	101.7	22.6	90.4	19.0	79.1	15.6	67.8	12.7	56.5	10.08	45.2	7.83	33.9	5.94
9.0	7.9	113.0	113.0	27.8	101.7	23.5	90.4	19.7	79.1	16.2	67.8	13.1	56.5	10.39	45.2	8.04	33.9	6.07
7.0	6.0	113.0	113.0	29.0	101.7	24.5	90.4	20.5	79.1	16.8	67.8	13.6	56.5	10.74	45.2	8.27	33.9	6.21
5.0	4.1	109.0	109.0	28.8	98.1	24.4	87.2	20.3	76.3	16.7	65.4	13.5	54.5	10.65	43.6	8.21	32.7	6.16
3.0	2.2	104.9	104.9	28.6	94.4	24.2	83.9	20.2	73.4	16.6	62.9	13.4	52.5	10.57	42.0	8.15	31.5	6.12
0.0	-0.7	98.7	98.7	28.2	88.9	23.9	79.0	20.0	69.1	16.4	59.2	13.2	49.4	10.45	39.5	8.05	29.6	6.04
-3.0	-3.7	92.3	92.3	27.9	83.1	23.6	73.9	19.7	64.6	16.2	55.4	13.1	46.2	10.32	36.9	7.95	27.7	5.97
-5.0	-5.6	88.3	88.3	27.6	79.5	23.4	70.6	19.5	61.8	16.1	53.0	13.0	44.1	10.24	35.3	7.89	26.5	5.92
-7.0	-7.6	84.0	84.0	27.4	75.6	23.2	67.2	19.4	58.8	15.9	50.4	12.9	42.0	10.15	33.6	7.82	25.2	5.87
-10	-10.5	77.9	77.9	27.1	70.1	22.9	62.3	19.1	54.5	15.7	46.7	12.7	38.9	10.03	31.1	7.73	23.4	5.80
-14.5	-15.0	68.3	68.3	26.6	61.4	22.5	54.6	18.8	47.8	15.4	41.0	12.5	34.1	9.83	27.3	7.58	20.5	5.69

TC : Total Capacity PI : Power Input
 Indoor air temperature conditions : 20.0 °C dry-bulb



MMY-AP3816HT8P (38HP, 106.5kW system)

Cooling			Compressor + Outdoor Fan Power consumption (kW)															
Outdoor Unit Dry-Bulb (°C)		Outdoor Unit 100% Cooling Capacity (kW)	100%		90%		80%		70%		60%		50%		40%		30%	
			TC (kW)	PI (kW)	TC (kW)	PI (kW)	TC (kW)	PI (kW)	TC (kW)	PI (kW)	TC (kW)	PI (kW)	TC (kW)	PI (kW)	TC (kW)	PI (kW)	TC (kW)	PI (kW)
40		99.1	99.1	37.4	89.2	30.6	79.3	24.5	69.4	19.1	59.5	14.5	49.6	10.5	39.6	7.34	29.7	4.88
39		100.7	100.7	36.8	90.6	30.1	80.6	24.1	70.5	18.8	60.4	14.2	50.3	10.4	40.3	7.23	30.2	4.80
37		103.7	103.7	35.7	93.3	29.2	83.0	23.4	72.6	18.2	62.2	13.8	51.9	10.1	41.5	7.01	31.1	4.66
35		106.5	106.5	34.6	95.9	28.3	85.2	22.6	74.6	17.7	63.9	13.4	53.3	9.75	42.6	6.79	32.0	4.51
33		106.5	106.5	32.0	95.9	26.1	85.2	20.9	74.6	16.4	63.9	12.4	53.3	9.06	42.6	6.33	32.0	4.23
31		106.5	106.5	29.6	95.9	24.2	85.2	19.4	74.6	15.2	63.9	11.53	53.3	8.44	42.6	5.92	32.0	3.98
30		106.5	106.5	28.6	95.9	23.4	85.2	18.7	74.6	14.7	63.9	11.13	53.3	8.15	42.6	5.73	32.0	3.86
29		106.5	106.5	27.5	95.9	22.5	85.2	18.1	74.6	14.1	63.9	10.75	53.3	7.88	42.6	5.55	32.0	3.74
27		106.5	106.5	25.6	95.9	21.0	85.2	16.9	74.6	13.2	63.9	10.04	53.3	7.37	42.6	5.20	32.0	3.53
25		106.5	106.5	23.9	95.9	19.6	85.2	15.7	74.6	12.3	63.9	9.39	53.3	6.91	42.6	4.88	32.0	3.32
23		106.5	106.5	22.8	95.9	18.7	85.2	15.0	74.6	11.8	63.9	8.98	53.3	6.61	42.6	4.69	32.0	3.20
21		106.5	106.5	22.3	95.9	18.3	85.2	14.7	74.6	11.53	63.9	8.80	53.3	6.49	42.6	4.61	32.0	3.16
20		106.5	106.5	22.1	95.9	18.1	85.2	14.6	74.6	11.42	63.9	8.71	53.3	6.43	42.6	4.57	32.0	3.14
19		106.5	106.5	21.9	95.9	17.9	85.2	14.4	74.6	11.32	63.9	8.64	53.3	6.38	42.6	4.54	32.0	3.12
17		106.5	106.5	21.5	95.9	17.6	85.2	14.2	74.6	11.14	63.9	8.51	53.3	6.29	42.6	4.48	32.0	3.09
15		106.5	106.5	21.2	95.9	17.4	85.2	14.0	74.6	10.98	63.9	8.39	53.3	6.21	42.6	4.43	32.0	3.06

TC : Total Capacity PI : Power Input
 Indoor air temperature conditions : 27.0 °C dry-bulb / 19.0 °C wet-bulb

Heating			Compressor + Outdoor Fan Power consumption (kW)															
Outdoor Unit		Outdoor Unit 100% Cooling Capacity (kW)	100%		90%		80%		70%		60%		50%		40%		30%	
Dry-Bulb (°C)	Wet-Bulb (°C)		TC (kW)	PI (kW)	TC (kW)	PI (kW)	TC (kW)	PI (kW)	TC (kW)	PI (kW)	TC (kW)	PI (kW)	TC (kW)	PI (kW)	TC (kW)	PI (kW)	TC (kW)	PI (kW)
15.0	13.7	114.0	114.0	24.7	102.6	21.0	91.2	17.7	79.8	14.7	68.4	12.0	57.0	9.57	45.6	7.51	34.2	5.77
13.0	11.8	114.0	114.0	25.7	102.6	21.8	91.2	18.3	79.8	15.2	68.4	12.3	57.0	9.84	45.6	7.69	34.2	5.88
11.0	9.8	114.0	114.0	26.7	102.6	22.7	91.2	19.0	79.8	15.7	68.4	12.8	57.0	10.1	45.6	7.90	34.2	6.01
9.0	7.9	114.0	114.0	27.9	102.6	23.6	91.2	19.8	79.8	16.3	68.4	13.2	57.0	10.5	45.6	8.11	34.2	6.14
7.0	6.0	114.0	114.0	29.1	102.6	24.6	91.2	20.6	79.8	16.9	68.4	13.7	57.0	10.8	45.6	8.34	34.2	6.28
5.0	4.1	109.9	109.9	28.9	98.9	24.5	87.9	20.4	76.9	16.8	65.9	13.6	55.0	10.7	44.0	8.28	33.0	6.23
3.0	2.2	105.8	105.8	28.7	95.2	24.3	84.7	20.3	74.1	16.7	63.5	13.5	52.9	10.6	42.3	8.22	31.7	6.18
0.0	-0.7	99.6	99.6	28.3	89.6	24.0	79.7	20.0	69.7	16.5	59.8	13.3	49.8	10.5	39.8	8.12	29.9	6.11
-3.0	-3.7	93.2	93.2	28.0	83.8	23.7	74.5	19.8	65.2	16.3	55.9	13.1	46.6	10.4	37.3	8.02	27.9	6.03
-5.0	-5.6	89.1	89.1	27.7	80.2	23.5	71.3	19.6	62.4	16.1	53.4	13.0	44.5	10.3	35.6	7.96	26.7	5.99
-7.0	-7.6	84.8	84.8	27.5	76.3	23.3	67.8	19.5	59.3	16.0	50.9	12.9	42.4	10.2	33.9	7.89	25.4	5.94
-10	-10.5	78.5	78.5	27.2	70.7	23.0	62.8	19.2	55.0	15.8	47.1	12.8	39.3	10.1	31.4	7.79	23.6	5.86
-14.5	-15.0	68.9	68.9	26.6	62.0	22.6	55.1	18.9	48.2	15.5	41.3	12.5	34.4	9.90	27.6	7.64	20.7	5.75

TC : Total Capacity PI : Power Input
 Indoor air temperature conditions : 20.0 °C dry-bulb



MMY-AP4016HT8P (40HP, 112kW system)

Cooling			Compressor + Outdoor Fan Power consumption (kW)															
Outdoor Unit Dry-Bulb (°C)		Outdoor Unit 100% Cooling Capacity (kW)	100%		90%		80%		70%		60%		50%		40%		30%	
			TC (kW)	PI (kW)	TC (kW)	PI (kW)	TC (kW)	PI (kW)	TC (kW)	PI (kW)	TC (kW)	PI (kW)	TC (kW)	PI (kW)	TC (kW)	PI (kW)	TC (kW)	PI (kW)
40		104.2	104.2	38.5	93.8	31.3	83.4	25.0	73.0	19.5	62.5	14.8	52.1	10.8	41.7	7.62	31.3	5.24
39		105.9	105.9	37.9	95.3	30.9	84.7	24.7	74.1	19.2	63.5	14.5	52.9	10.6	42.4	7.51	31.8	5.16
37		109.1	109.1	36.7	98.2	29.9	87.2	23.9	76.3	18.6	65.4	14.1	54.5	10.3	43.6	7.28	32.7	5.01
35		112.0	112.0	35.8	100.8	29.0	89.6	23.2	78.4	18.0	67.2	13.7	56.0	9.99	44.8	7.05	33.6	4.85
33		112.0	112.0	32.9	100.8	26.8	89.6	21.4	78.4	16.7	67.2	12.7	56.0	9.29	44.8	6.59	33.6	4.57
31		112.0	112.0	30.4	100.8	24.8	89.6	19.9	78.4	15.5	67.2	11.8	56.0	8.66	44.8	6.17	33.6	4.31
30		112.0	112.0	29.3	100.8	23.9	89.6	19.2	78.4	15.0	67.2	11.4	56.0	8.37	44.8	5.98	33.6	4.18
29		112.0	112.0	28.3	100.8	23.1	89.6	18.5	78.4	14.4	67.2	11.0	56.0	8.10	44.8	5.79	33.6	4.07
27		112.0	112.0	26.3	100.8	21.5	89.6	17.2	78.4	13.5	67.2	10.3	56.0	7.58	44.8	5.44	33.6	3.84
25		112.0	112.0	24.5	100.8	20.1	89.6	16.1	78.4	12.6	67.2	9.59	56.0	7.11	44.8	5.12	33.6	3.63
23		112.0	112.0	23.4	100.8	19.1	89.6	15.3	78.4	12.0	67.2	9.18	56.0	6.81	44.8	4.92	33.6	3.51
21		112.0	112.0	22.9	100.8	18.7	89.6	15.0	78.4	11.8	67.2	9.00	56.0	6.69	44.8	4.84	33.6	3.47
20		112.0	112.0	22.6	100.8	18.5	89.6	14.9	78.4	11.7	67.2	8.91	56.0	6.63	44.8	4.81	33.6	3.45
19		112.0	112.0	22.4	100.8	18.3	89.6	14.7	78.4	11.6	67.2	8.84	56.0	6.58	44.8	4.78	33.6	3.43
17		112.0	112.0	22.0	100.8	18.0	89.6	14.5	78.4	11.4	67.2	8.70	56.0	6.49	44.8	4.72	33.6	3.40
15		112.0	112.0	21.7	100.8	17.8	89.6	14.3	78.4	11.2	67.2	8.59	56.0	6.41	44.8	4.67	33.6	3.37

TC : Total Capacity PI : Power Input
 Indoor air temperature conditions : 27.0 °C dry-bulb / 19.0 °C wet-bulb

Heating			Compressor + Outdoor Fan Power consumption (kW)															
Outdoor Unit Dry-Bulb (°C) / Wet-Bulb (°C)		Outdoor Unit 100% Cooling Capacity (kW)	100%		90%		80%		70%		60%		50%		40%		30%	
			TC (kW)	PI (kW)	TC (kW)	PI (kW)	TC (kW)	PI (kW)	TC (kW)	PI (kW)	TC (kW)	PI (kW)	TC (kW)	PI (kW)	TC (kW)	PI (kW)	TC (kW)	PI (kW)
15.0	13.7	126.0	126.0	28.2	113.4	24.2	100.8	20.4	88.2	17.0	75.6	13.8	63.0	11.0	50.4	8.40	37.8	6.13
13.0	11.8	126.0	126.0	29.3	113.4	25.1	100.8	21.2	88.2	17.6	75.6	14.3	63.0	11.3	50.4	8.64	37.8	6.29
11.0	9.8	126.0	126.0	30.5	113.4	26.1	100.8	22.0	88.2	18.2	75.6	14.8	63.0	11.7	50.4	8.91	37.8	6.46
9.0	7.9	126.0	126.0	31.7	113.4	27.1	100.8	22.8	88.2	18.9	75.6	15.3	63.0	12.1	50.4	9.18	37.8	6.63
7.0	6.0	126.0	126.0	33.0	113.4	28.2	100.8	23.7	88.2	19.6	75.6	15.9	63.0	12.5	50.4	9.47	37.8	6.82
5.0	4.1	121.5	121.5	32.7	109.3	27.9	97.2	23.5	85.0	19.4	72.9	15.7	60.7	12.4	48.6	9.40	36.4	6.77
3.0	2.2	117.0	117.0	32.5	105.3	27.7	93.6	23.3	81.9	19.3	70.2	15.6	58.5	12.3	46.8	9.32	35.1	6.72
0.0	-0.7	110.1	110.1	32.1	99.1	27.4	88.1	23.1	77.1	19.1	66.1	15.4	55.0	12.1	44.0	9.21	33.0	6.64
-3.0	-3.7	103.0	103.0	31.7	92.7	27.1	82.4	22.8	72.1	18.8	61.8	15.2	51.5	12.0	41.2	9.10	30.9	6.56
-5.0	-5.6	98.5	98.5	31.5	88.6	26.9	78.8	22.6	68.9	18.7	59.1	15.1	49.2	11.9	39.4	9.03	29.5	6.51
-7.0	-7.6	93.7	93.7	31.2	84.3	26.6	75.0	22.4	65.6	18.5	56.2	15.0	46.9	11.8	37.5	8.95	28.1	6.45
-10	-10.5	86.8	86.8	30.8	78.1	26.3	69.5	22.1	60.8	18.3	52.1	14.8	43.4	11.7	34.7	8.84	26.0	6.37
-14.5	-15.0	76.1	76.1	30.2	68.5	25.8	60.9	21.7	53.3	17.9	45.7	14.5	38.1	11.4	30.5	8.67	22.8	6.25

TC : Total Capacity PI : Power Input
 Indoor air temperature conditions : 20.0 °C dry-bulb



MMY-AP4216HT8P (42HP, 117.5kW system)

Cooling			Compressor + Outdoor Fan Power consumption (kW)														
Outdoor Unit Dry-Bulb (°C)	Outdoor Unit 100% Cooling Capacity (kW)	100%		90%		80%		70%		60%		50%		40%		30%	
		TC	PI	TC	PI	TC	PI	TC	PI	TC	PI	TC	PI	TC	PI	TC	PI
		(kW)	(kW)	(kW)	(kW)	(kW)	(kW)	(kW)	(kW)	(kW)	(kW)	(kW)	(kW)	(kW)	(kW)	(kW)	(kW)
40	109.3	109.3	41.9	98.4	34.1	87.5	27.2	76.5	21.2	65.6	16.0	54.7	11.6	43.7	8.12	32.8	5.48
39	111.1	111.1	41.3	100.0	33.6	88.9	26.8	77.8	20.9	66.7	15.7	55.5	11.4	44.4	8.00	33.3	5.40
37	114.4	114.4	40.0	103.0	32.6	91.5	26.0	80.1	20.2	68.7	15.3	57.2	11.1	45.8	7.76	34.3	5.23
35	117.5	117.5	38.9	105.8	31.6	94.0	25.2	82.3	19.6	70.5	14.8	58.8	10.8	47.0	7.52	35.3	5.07
33	117.5	117.5	35.8	105.8	29.2	94.0	23.3	82.3	18.1	70.5	13.7	58.8	9.99	47.0	7.01	35.3	4.76
31	117.5	117.5	33.2	105.8	27.1	94.0	21.6	82.3	16.8	70.5	12.7	58.8	9.31	47.0	6.56	35.3	4.49
30	117.5	117.5	32.0	105.8	26.1	94.0	20.8	82.3	16.2	70.5	12.3	58.8	9.00	47.0	6.35	35.3	4.36
29	117.5	117.5	30.8	105.8	25.1	94.0	20.1	82.3	15.7	70.5	11.9	58.8	8.70	47.0	6.15	35.3	4.23
27	117.5	117.5	28.7	105.8	23.4	94.0	18.7	82.3	14.6	70.5	11.1	58.8	8.14	47.0	5.77	35.3	3.99
25	117.5	117.5	26.7	105.8	21.8	94.0	17.5	82.3	13.6	70.5	10.4	58.8	7.62	47.0	5.42	35.3	3.77
23	117.5	117.5	25.5	105.8	20.8	94.0	16.7	82.3	13.0	70.5	9.91	58.8	7.30	47.0	5.21	35.3	3.64
21	117.5	117.5	24.9	105.8	20.4	94.0	16.3	82.3	12.75	70.5	9.71	58.8	7.16	47.0	5.12	35.3	3.59
20	117.5	117.5	24.7	105.8	20.2	94.0	16.1	82.3	12.63	70.5	9.62	58.8	7.10	47.0	5.09	35.3	3.57
19	117.5	117.5	24.4	105.8	20.0	94.0	16.0	82.3	12.51	70.5	9.53	58.8	7.04	47.0	5.05	35.3	3.55
17	117.5	117.5	24.0	105.8	19.6	94.0	15.7	82.3	12.31	70.5	9.38	58.8	6.94	47.0	4.99	35.3	3.52
15	117.5	117.5	23.6	105.8	19.3	94.0	15.5	82.3	12.14	70.5	9.26	58.8	6.86	47.0	4.93	35.3	3.49

TC : Total Capacity PI : Power Input
 Indoor air temperature conditions : 27.0 °C dry-bulb / 19.0 °C wet-bulb

Heating			Compressor + Outdoor Fan Power consumption (kW)															
Outdoor Unit		Outdoor Unit 100% Cooling Capacity (kW)	100%		90%		80%		70%		60%		50%		40%		30%	
Dry-Bulb (°C)	Wet-Bulb (°C)		TC	PI	TC	PI	TC	PI	TC	PI	TC	PI	TC	PI	TC	PI	TC	PI
(°C)	(°C)		(kW)	(kW)	(kW)	(kW)	(kW)	(kW)	(kW)	(kW)	(kW)	(kW)	(kW)	(kW)	(kW)	(kW)	(kW)	(kW)
15.0	13.7	127.0	127.0	28.3	114.3	24.3	101.6	20.5	88.9	17.1	76.2	13.9	63.5	11.0	50.8	8.47	38.1	6.20
13.0	11.8	127.0	127.0	29.4	114.3	25.2	101.6	21.2	88.9	17.6	76.2	14.4	63.5	11.4	50.8	8.71	38.1	6.35
11.0	9.8	127.0	127.0	30.6	114.3	26.1	101.6	22.1	88.9	18.3	76.2	14.9	63.5	11.8	50.8	8.97	38.1	6.53
9.0	7.9	127.0	127.0	31.8	114.3	27.2	101.6	22.9	88.9	19.0	76.2	15.4	63.5	12.1	50.8	9.25	38.1	6.70
7.0	6.0	127.0	127.0	33.1	114.3	28.3	101.6	23.8	88.9	19.7	76.2	15.9	63.5	12.5	50.8	9.54	38.1	6.89
5.0	4.1	122.4	122.4	32.8	110.2	28.0	98.0	23.6	85.7	19.5	73.5	15.8	61.2	12.5	49.0	9.46	36.7	6.84
3.0	2.2	117.9	117.9	32.6	106.1	27.8	94.3	23.4	82.5	19.4	70.7	15.7	59.0	12.4	47.2	9.39	35.4	6.78
0.0	-0.7	111.0	111.0	32.2	99.9	27.5	88.8	23.1	77.7	19.1	66.6	15.5	55.5	12.2	44.4	9.28	33.3	6.70
-3.0	-3.7	103.8	103.8	31.8	93.4	27.2	83.0	22.9	72.6	18.9	62.3	15.3	51.9	12.1	41.5	9.17	31.1	6.62
-5.0	-5.6	99.2	99.2	31.6	89.3	26.9	79.4	22.7	69.5	18.8	59.5	15.2	49.6	12.0	39.7	9.09	29.8	6.57
-7.0	-7.6	94.4	94.4	31.3	85.0	26.7	75.6	22.5	66.1	18.6	56.7	15.1	47.2	11.9	37.8	9.02	28.3	6.51
-10	-10.5	87.5	87.5	30.9	78.8	26.4	70.0	22.2	61.3	18.4	52.5	14.9	43.8	11.7	35.0	8.91	26.3	6.43
-14.5	-15.0	76.7	76.7	30.3	69.1	25.9	61.4	21.8	53.7	18.0	46.0	14.6	38.4	11.5	30.7	8.74	23.0	6.31

TC : Total Capacity PI : Power Input
 Indoor air temperature conditions : 20.0 °C dry-bulb



MMY-AP4416HT8P (44HP, 123kW system)

Cooling			Compressor + Outdoor Fan Power consumption (kW)															
Outdoor Unit Dry-Bulb (°C)		Outdoor Unit 100% Cooling Capacity (kW)	100%		90%		80%		70%		60%		50%		40%		30%	
			TC (kW)	PI (kW)	TC (kW)	PI (kW)	TC (kW)	PI (kW)	TC (kW)	PI (kW)	TC (kW)	PI (kW)	TC (kW)	PI (kW)	TC (kW)	PI (kW)	TC (kW)	PI (kW)
40			114.5	114.5	45.4	103.0	36.9	91.6	29.4	80.1	22.9	68.7	17.2	57.2	12.4	45.8	8.62	34.3
39		116.3	116.3	44.7	104.7	36.4	93.0	29.0	81.4	22.5	69.8	16.9	58.2	12.3	46.5	8.49	34.9	5.63
37		119.8	119.8	43.3	107.8	35.3	95.8	28.1	83.8	21.8	71.9	16.4	59.9	11.9	47.9	8.24	35.9	5.46
35		123.0	123.0	42.0	110.7	34.2	98.4	27.2	86.1	21.2	73.8	15.9	61.5	11.5	49.2	7.98	36.9	5.29
33		123.0	123.0	38.8	110.7	31.6	98.4	25.2	86.1	19.6	73.8	14.7	61.5	10.7	49.2	7.44	36.9	4.96
31		123.0	123.0	35.9	110.7	29.3	98.4	23.3	86.1	18.2	73.8	13.7	61.5	9.96	49.2	6.95	36.9	4.67
30		123.0	123.0	34.6	110.7	28.2	98.4	22.5	86.1	17.5	73.8	13.2	61.5	9.62	49.2	6.72	36.9	4.53
29		123.0	123.0	33.3	110.7	27.2	98.4	21.7	86.1	16.9	73.8	12.8	61.5	9.29	49.2	6.51	36.9	4.40
27		123.0	123.0	31.0	110.7	25.3	98.4	20.2	86.1	15.7	73.8	11.9	61.5	8.69	49.2	6.10	36.9	4.14
25		123.0	123.0	28.9	110.7	23.6	98.4	18.9	86.1	14.7	73.8	11.1	61.5	8.13	49.2	5.73	36.9	3.91
23		123.0	123.0	27.6	110.7	22.5	98.4	18.0	86.1	14.0	73.8	10.6	61.5	7.79	49.2	5.50	36.9	3.76
21		123.0	123.0	27.0	110.7	22.0	98.4	17.6	86.1	13.7	73.8	10.4	61.5	7.64	49.2	5.40	36.9	3.71
20		123.0	123.0	26.7	110.7	21.8	98.4	17.4	86.1	13.6	73.8	10.3	61.5	7.57	49.2	5.36	36.9	3.69
19		123.0	123.0	26.4	110.7	21.6	98.4	17.3	86.1	13.5	73.8	10.2	61.5	7.51	49.2	5.32	36.9	3.67
17		123.0	123.0	26.0	110.7	21.2	98.4	17.0	86.1	13.3	73.8	10.1	61.5	7.40	49.2	5.25	36.9	3.63
15		123.0	123.0	25.6	110.7	20.9	98.4	16.7	86.1	13.1	73.8	9.93	61.5	7.30	49.2	5.19	36.9	3.60

TC : Total Capacity PI : Power Input
 Indoor air temperature conditions : 27.0 °C dry-bulb / 19.0 °C wet-bulb

Heating			Compressor + Outdoor Fan Power consumption (kW)															
Outdoor Unit		Outdoor Unit 100% Cooling Capacity (kW)	100%		90%		80%		70%		60%		50%		40%		30%	
Dry-Bulb (°C)	Wet-Bulb (°C)		TC (kW)	PI (kW)	TC (kW)	PI (kW)	TC (kW)	PI (kW)	TC (kW)	PI (kW)	TC (kW)	PI (kW)	TC (kW)	PI (kW)	TC (kW)	PI (kW)	TC (kW)	PI (kW)
15.0	13.7		128.0	128.0	28.4	115.2	24.4	102.4	20.6	89.6	17.1	76.8	14.0	64.0	11.1	51.2	8.54	38.4
13.0	11.8	128.0	128.0	29.5	115.2	25.2	102.4	21.3	89.6	17.7	76.8	14.4	64.0	11.4	51.2	8.78	38.4	6.42
11.0	9.8	128.0	128.0	30.7	115.2	26.2	102.4	22.1	89.6	18.4	76.8	14.9	64.0	11.8	51.2	9.04	38.4	6.59
9.0	7.9	128.0	128.0	31.9	115.2	27.2	102.4	23.0	89.6	19.0	76.8	15.4	64.0	12.2	51.2	9.31	38.4	6.77
7.0	6.0	128.0	128.0	33.2	115.2	28.3	102.4	23.9	89.6	19.8	76.8	16.0	64.0	12.6	51.2	9.61	38.4	6.96
5.0	4.1	123.4	123.4	32.9	111.1	28.1	98.7	23.7	86.4	19.6	74.0	15.9	61.7	12.5	49.4	9.53	37.0	6.90
3.0	2.2	118.8	118.8	32.7	106.9	27.9	95.1	23.5	83.2	19.5	71.3	15.8	59.4	12.4	47.5	9.46	35.6	6.85
0.0	-0.7	111.8	111.8	32.3	100.7	27.6	89.5	23.2	78.3	19.2	67.1	15.6	55.9	12.3	44.7	9.35	33.6	6.77
-3.0	-3.7	104.6	104.6	31.9	94.1	27.2	83.7	22.9	73.2	19.0	62.8	15.4	52.3	12.1	41.8	9.23	31.4	6.69
-5.0	-5.6	100.0	100.0	31.7	90.0	27.0	80.0	22.8	70.0	18.8	60.0	15.3	50.0	12.0	40.0	9.16	30.0	6.63
-7.0	-7.6	95.2	95.2	31.4	85.7	26.8	76.2	22.6	66.6	18.7	57.1	15.1	47.6	11.9	38.1	9.08	28.6	6.58
-10	-10.5	88.2	88.2	31.0	79.4	26.5	70.6	22.3	61.7	18.4	52.9	14.9	44.1	11.8	35.3	8.97	26.5	6.50
-14.5	-15.0	77.3	77.3	30.4	69.6	26.0	61.9	21.9	54.1	18.1	46.4	14.7	38.7	11.6	30.9	8.80	23.2	6.37

TC : Total Capacity PI : Power Input
 Indoor air temperature conditions : 20.0 °C dry-bulb



MMY-AP4616HT8P (46HP, 130kW system)

Cooling			Compressor + Outdoor Fan Power consumption (kW)															
Outdoor Unit Dry-Bulb (°C)		Outdoor Unit 100% Cooling Capacity (kW)	100%		90%		80%		70%		60%		50%		40%		30%	
			TC (kW)	PI (kW)	TC (kW)	PI (kW)	TC (kW)	PI (kW)	TC (kW)	PI (kW)	TC (kW)	PI (kW)	TC (kW)	PI (kW)	TC (kW)	PI (kW)	TC (kW)	PI (kW)
40		121.0	121.0	41.8	108.9	34.4	96.8	27.8	84.7	21.9	72.6	16.8	60.5	12.4	48.4	8.78	36.3	5.90
39		122.9	122.9	41.2	110.6	33.9	98.3	27.4	86.0	21.6	73.8	16.5	61.5	12.2	49.2	8.65	36.9	5.82
37		126.6	126.6	39.9	113.9	32.9	101.3	26.6	88.6	20.9	76.0	16.0	63.3	11.9	50.6	8.39	38.0	5.64
35		130.0	130.0	38.7	117.0	31.9	104.0	25.7	91.0	20.3	78.0	15.5	65.0	11.5	52.0	8.13	39.0	5.46
33		130.0	130.0	35.8	117.0	29.5	104.0	23.8	91.0	18.8	78.0	14.4	65.0	10.7	52.0	7.59	39.0	5.13
31		130.0	130.0	33.2	117.0	27.4	104.0	22.2	91.0	17.5	78.0	13.4	65.0	9.98	52.0	7.10	39.0	4.82
30		130.0	130.0	32.1	117.0	26.4	104.0	21.4	91.0	16.9	78.0	13.0	65.0	9.65	52.0	6.88	39.0	4.68
29		130.0	130.0	30.9	117.0	25.5	104.0	20.6	91.0	16.3	78.0	12.6	65.0	9.33	52.0	6.66	39.0	4.54
27		130.0	130.0	28.8	117.0	23.8	104.0	19.3	91.0	15.2	78.0	11.7	65.0	8.74	52.0	6.25	39.0	4.28
25		130.0	130.0	26.9	117.0	22.2	104.0	18.0	91.0	14.3	78.0	11.0	65.0	8.20	52.0	5.88	39.0	4.03
23		130.0	130.0	25.7	117.0	21.2	104.0	17.2	91.0	13.6	78.0	10.5	65.0	7.86	52.0	5.64	39.0	3.88
21		130.0	130.0	25.2	117.0	20.8	104.0	16.9	91.0	13.4	78.0	10.3	65.0	7.71	52.0	5.55	39.0	3.83
20		130.0	130.0	24.9	117.0	20.6	104.0	16.7	91.0	13.2	78.0	10.2	65.0	7.65	52.0	5.51	39.0	3.80
19		130.0	130.0	24.7	117.0	20.4	104.0	16.6	91.0	13.1	78.0	10.1	65.0	7.59	52.0	5.47	39.0	3.78
17		130.0	130.0	24.3	117.0	20.1	104.0	16.3	91.0	12.9	78.0	10.0	65.0	7.48	52.0	5.40	39.0	3.74
15		130.0	130.0	23.9	117.0	19.8	104.0	16.1	91.0	12.8	78.0	9.87	65.0	7.39	52.0	5.34	39.0	3.71

TC : Total Capacity PI : Power Input
 Indoor air temperature conditions : 27.0 °C dry-bulb / 19.0 °C wet-bulb

Heating			Compressor + Outdoor Fan Power consumption (kW)															
Outdoor Unit		Outdoor Unit 100% Cooling Capacity (kW)	100%		90%		80%		70%		60%		50%		40%		30%	
Dry-Bulb (°C)	Wet-Bulb (°C)		TC (kW)	PI (kW)	TC (kW)	PI (kW)	TC (kW)	PI (kW)	TC (kW)	PI (kW)	TC (kW)	PI (kW)	TC (kW)	PI (kW)	TC (kW)	PI (kW)	TC (kW)	PI (kW)
15.0	13.7	145.0	145.0	29.9	130.5	25.2	116.0	21.1	101.5	17.4	87.0	14.2	72.5	11.5	58.0	9.33	43.5	7.63
13.0	11.8	145.0	145.0	31.1	130.5	26.2	116.0	21.8	101.5	18.0	87.0	14.6	72.5	11.8	58.0	9.51	43.5	7.73
11.0	9.8	145.0	145.0	32.5	130.5	27.4	116.0	22.7	101.5	18.7	87.0	15.1	72.5	12.2	58.0	9.72	43.5	7.84
9.0	7.9	145.0	145.0	34.0	130.5	28.5	116.0	23.7	101.5	19.4	87.0	15.7	72.5	12.5	58.0	9.94	43.5	7.95
7.0	6.0	145.0	145.0	35.6	130.5	29.8	116.0	24.7	101.5	20.1	87.0	16.2	72.5	12.9	58.0	10.18	43.5	8.08
5.0	4.1	140.0	140.0	35.3	126.0	29.6	112.0	24.5	98.0	20.0	84.0	16.1	70.0	12.8	56.0	10.11	42.0	8.02
3.0	2.2	134.9	134.9	35.1	121.4	29.4	108.0	24.3	94.5	19.9	81.0	16.0	67.5	12.7	54.0	10.04	40.5	7.96
0.0	-0.7	127.3	127.3	34.7	114.5	29.1	101.8	24.1	89.1	19.6	76.4	15.8	63.6	12.6	50.9	9.93	38.2	7.88
-3.0	-3.7	119.3	119.3	34.3	107.4	28.8	95.5	23.8	83.5	19.4	71.6	15.6	59.7	12.4	47.7	9.81	35.8	7.79
-5.0	-5.6	114.3	114.3	34.1	102.9	28.6	91.4	23.6	80.0	19.3	68.6	15.5	57.1	12.3	45.7	9.74	34.3	7.73
-7.0	-7.6	109.0	109.0	33.8	98.1	28.3	87.2	23.4	76.3	19.1	65.4	15.4	54.5	12.2	43.6	9.67	32.7	7.67
-10	-10.5	101.3	101.3	33.4	91.2	28.0	81.1	23.2	70.9	18.9	60.8	15.2	50.7	12.1	40.5	9.56	30.4	7.59
-14.5	-15.0	89.4	89.4	32.8	80.5	27.5	71.5	22.8	62.6	18.6	53.7	15.0	44.7	11.9	35.8	9.39	26.8	7.45

TC : Total Capacity PI : Power Input
 Indoor air temperature conditions : 20.0 °C dry-bulb



MMY-AP4816HT8P (48HP, 135kW system)

Cooling			Compressor + Outdoor Fan Power consumption (kW)															
Outdoor Unit Dry-Bulb (°C)		Outdoor Unit 100% Cooling Capacity (kW)	100%		90%		80%		70%		60%		50%		40%		30%	
			TC (kW)	PI (kW)	TC (kW)	PI (kW)	TC (kW)	PI (kW)	TC (kW)	PI (kW)	TC (kW)	PI (kW)	TC (kW)	PI (kW)	TC (kW)	PI (kW)	TC (kW)	PI (kW)
40		125.6	125.6	44.1	113.1	36.3	100.5	29.2	87.9	23.0	75.4	17.6	62.8	12.9	50.3	9.09	37.7	6.05
39		127.6	127.6	43.4	114.9	35.7	102.1	28.8	89.4	22.7	76.6	17.3	63.8	12.7	51.1	8.96	38.3	5.96
37		131.5	131.5	42.1	118.3	34.6	105.2	27.9	92.0	22.0	78.9	16.8	65.7	12.4	52.6	8.69	39.4	5.78
35		135.0	135.0	40.8	121.5	33.6	108.0	27.0	94.5	21.3	81.0	16.3	67.5	12.0	54.0	8.41	40.5	5.60
33		135.0	135.0	37.7	121.5	31.1	108.0	25.1	94.5	19.7	81.0	15.1	67.5	11.1	54.0	7.85	40.5	5.25
31		135.0	135.0	35.0	121.5	28.8	108.0	23.3	94.5	18.4	81.0	14.1	67.5	10.38	54.0	7.34	40.5	4.93
30		135.0	135.0	33.8	121.5	27.8	108.0	22.5	94.5	17.7	81.0	13.6	67.5	10.04	54.0	7.11	40.5	4.78
29		135.0	135.0	32.6	121.5	26.8	108.0	21.7	94.5	17.1	81.0	13.1	67.5	9.71	54.0	6.88	40.5	4.64
27		135.0	135.0	30.4	121.5	25.0	108.0	20.2	94.5	16.0	81.0	12.3	67.5	9.09	54.0	6.46	40.5	4.37
25		135.0	135.0	28.4	121.5	23.4	108.0	18.9	94.5	14.9	81.0	11.5	67.5	8.51	54.0	6.06	40.5	4.12
23		135.0	135.0	27.1	121.5	22.3	108.0	18.1	94.5	14.3	81.0	11.0	67.5	8.16	54.0	5.82	40.5	3.96
21		135.0	135.0	26.5	121.5	21.9	108.0	17.7	94.5	14.0	81.0	10.8	67.5	8.01	54.0	5.72	40.5	3.91
20		135.0	135.0	26.2	121.5	21.6	108.0	17.5	94.5	13.9	81.0	10.7	67.5	7.94	54.0	5.68	40.5	3.88
19		135.0	135.0	26.0	121.5	21.4	108.0	17.4	94.5	13.7	81.0	10.6	67.5	7.88	54.0	5.64	40.5	3.86
17		135.0	135.0	25.6	121.5	21.1	108.0	17.1	94.5	13.5	81.0	10.4	67.5	7.77	54.0	5.56	40.5	3.81
15		135.0	135.0	25.2	121.5	20.8	108.0	16.8	94.5	13.3	81.0	10.28	67.5	7.67	54.0	5.50	40.5	3.78

TC : Total Capacity PI : Power Input
 Indoor air temperature conditions : 27.0 °C dry-bulb / 19.0 °C wet-bulb

Heating			Compressor + Outdoor Fan Power consumption (kW)															
Outdoor Unit Dry-Bulb (°C) / Wet-Bulb (°C)		Outdoor Unit 100% Cooling Capacity (kW)	100%		90%		80%		70%		60%		50%		40%		30%	
			TC (kW)	PI (kW)	TC (kW)	PI (kW)	TC (kW)	PI (kW)	TC (kW)	PI (kW)	TC (kW)	PI (kW)	TC (kW)	PI (kW)	TC (kW)	PI (kW)	TC (kW)	PI (kW)
15.0	13.7	150.0	150.0	31.4	135.0	26.5	120.0	22.1	105.0	18.2	90.0	14.9	75.0	12.0	60.0	9.72	45.0	7.92
13.0	11.8	150.0	150.0	32.8	135.0	27.6	120.0	23.0	105.0	18.9	90.0	15.3	75.0	12.4	60.0	9.91	45.0	8.02
11.0	9.8	150.0	150.0	34.3	135.0	28.8	120.0	23.9	105.0	19.6	90.0	15.9	75.0	12.7	60.0	10.1	45.0	8.14
9.0	7.9	150.0	150.0	35.8	135.0	30.0	120.0	24.9	105.0	20.3	90.0	16.4	75.0	13.1	60.0	10.4	45.0	8.26
7.0	6.0	150.0	150.0	37.5	135.0	31.4	120.0	26.0	105.0	21.2	90.0	17.0	75.0	13.5	60.0	10.6	45.0	8.40
5.0	4.1	144.6	144.6	37.2	130.2	31.2	115.7	25.8	101.2	21.0	86.8	16.9	72.3	13.4	57.9	10.5	43.4	8.33
3.0	2.2	139.3	139.3	36.9	125.3	30.9	111.4	25.6	97.5	20.8	83.6	16.7	69.6	13.3	55.7	10.5	41.8	8.27
0.0	-0.7	131.1	131.1	36.5	118.0	30.6	104.8	25.3	91.7	20.6	78.6	16.5	65.5	13.1	52.4	10.3	39.3	8.17
-3.0	-3.7	122.6	122.6	36.0	110.3	30.2	98.1	25.0	85.8	20.3	73.5	16.3	61.3	13.0	49.0	10.2	36.8	8.07
-5.0	-5.6	117.2	117.2	35.8	105.5	29.9	93.8	24.8	82.0	20.2	70.3	16.2	58.6	12.9	46.9	10.1	35.2	8.01
-7.0	-7.6	111.6	111.6	35.5	100.4	29.7	89.2	24.5	78.1	20.0	66.9	16.1	55.8	12.8	44.6	10.0	33.5	7.94
-10	-10.5	103.4	103.4	35.0	93.0	29.3	82.7	24.2	72.3	19.8	62.0	15.9	51.7	12.6	41.3	9.92	31.0	7.84
-14.5	-15.0	90.6	90.6	34.3	81.6	28.8	72.5	23.8	63.4	19.4	54.4	15.6	45.3	12.4	36.3	9.73	27.2	7.69

TC : Total Capacity PI : Power Input
 Indoor air temperature conditions : 20.0 °C dry-bulb



MMY-AP5016HT8P (50HP, 140.4kW system)

Cooling			Compressor + Outdoor Fan Power consumption (kW)															
Outdoor Unit Dry-Bulb (°C)		Outdoor Unit 100% Cooling Capacity (kW)	100%		90%		80%		70%		60%		50%		40%		30%	
			TC (kW)	PI (kW)	TC (kW)	PI (kW)	TC (kW)	PI (kW)	TC (kW)	PI (kW)	TC (kW)	PI (kW)	TC (kW)	PI (kW)	TC (kW)	PI (kW)	TC (kW)	PI (kW)
40		130.7	130.7	44.5	117.6	36.8	104.5	29.9	91.5	23.7	78.4	18.2	65.3	13.6	52.3	9.66	39.2	6.51
39		132.8	132.8	43.8	119.5	36.3	106.2	29.4	92.9	23.3	79.7	18.0	66.4	13.4	53.1	9.52	39.8	6.41
37		136.7	136.7	42.5	123.0	35.2	109.4	28.5	95.7	22.6	82.0	17.4	68.4	13.0	54.7	9.23	41.0	6.22
35		140.4	140.4	41.2	126.4	34.1	112.3	27.6	98.3	21.9	84.2	16.9	70.2	12.6	56.2	8.94	42.1	6.02
33		140.4	140.4	38.1	126.4	31.6	112.3	25.6	98.3	20.3	84.2	15.7	70.2	11.7	56.2	8.35	42.1	5.65
31		140.4	140.4	35.4	126.4	29.3	112.3	23.8	98.3	18.9	84.2	14.6	70.2	10.9	56.2	7.82	42.1	5.31
30		140.4	140.4	34.2	126.4	28.3	112.3	23.0	98.3	18.3	84.2	14.1	70.2	10.6	56.2	7.57	42.1	5.15
29		140.4	140.4	33.0	126.4	27.3	112.3	22.2	98.3	17.7	84.2	13.7	70.2	10.2	56.2	7.33	42.1	5.00
27		140.4	140.4	30.8	126.4	25.5	112.3	20.8	98.3	16.5	84.2	12.8	70.2	9.58	56.2	6.89	42.1	4.71
25		140.4	140.4	28.8	126.4	23.8	112.3	19.4	98.3	15.5	84.2	12.0	70.2	8.98	56.2	6.47	42.1	4.44
23		140.4	140.4	27.5	126.4	22.8	112.3	18.6	98.3	14.8	84.2	11.5	70.2	8.62	56.2	6.22	42.1	4.28
21		140.4	140.4	26.9	126.4	22.3	112.3	18.2	98.3	14.5	84.2	11.3	70.2	8.46	56.2	6.12	42.1	4.22
20		140.4	140.4	26.7	126.4	22.1	112.3	18.0	98.3	14.4	84.2	11.2	70.2	8.39	56.2	6.07	42.1	4.19
19		140.4	140.4	26.4	126.4	21.9	112.3	17.9	98.3	14.2	84.2	11.1	70.2	8.33	56.2	6.03	42.1	4.16
17		140.4	140.4	26.0	126.4	21.6	112.3	17.6	98.3	14.0	84.2	10.9	70.2	8.22	56.2	5.95	42.1	4.12
15		140.4	140.4	25.6	126.4	21.3	112.3	17.4	98.3	13.8	84.2	10.77	70.2	8.12	56.2	5.89	42.1	4.08

TC : Total Capacity PI : Power Input
 Indoor air temperature conditions : 27.0 °C dry-bulb / 19.0 °C wet-bulb

Heating			Compressor + Outdoor Fan Power consumption (kW)															
Outdoor Unit		Outdoor Unit 100% Cooling Capacity (kW)	100%		90%		80%		70%		60%		50%		40%		30%	
Dry-Bulb (°C)	Wet-Bulb (°C)		TC (kW)	PI (kW)	TC (kW)	PI (kW)	TC (kW)	PI (kW)	TC (kW)	PI (kW)	TC (kW)	PI (kW)	TC (kW)	PI (kW)	TC (kW)	PI (kW)	TC (kW)	PI (kW)
15.0	13.7	156.0	156.0	32.6	140.4	27.7	124.8	23.2	109.2	19.2	93.6	15.7	78.0	12.7	62.4	10.1	46.8	8.00
13.0	11.8	156.0	156.0	33.9	140.4	28.7	124.8	24.0	109.2	19.9	93.6	16.2	78.0	13.0	62.4	10.3	46.8	8.12
11.0	9.8	156.0	156.0	35.4	140.4	29.9	124.8	25.0	109.2	20.6	93.6	16.7	78.0	13.4	62.4	10.6	46.8	8.27
9.0	7.9	156.0	156.0	36.9	140.4	31.2	124.8	26.0	109.2	21.4	93.6	17.3	78.0	13.8	62.4	10.8	46.8	8.42
7.0	6.0	156.0	156.0	38.6	140.4	32.5	124.8	27.1	109.2	22.2	93.6	17.9	78.0	14.2	62.4	11.1	46.8	8.58
5.0	4.1	150.6	150.6	38.3	135.6	32.3	120.5	26.9	105.4	22.1	90.4	17.8	75.3	14.1	60.2	11.0	45.2	8.52
3.0	2.2	145.2	145.2	38.1	130.7	32.1	116.2	26.7	101.7	21.9	87.1	17.7	72.6	14.0	58.1	11.0	43.6	8.46
0.0	-0.7	137.0	137.0	37.6	123.3	31.7	109.6	26.4	95.9	21.7	82.2	17.5	68.5	13.9	54.8	10.8	41.1	8.37
-3.0	-3.7	128.5	128.5	37.2	115.7	31.4	102.8	26.1	90.0	21.4	77.1	17.3	64.3	13.7	51.4	10.7	38.6	8.28
-5.0	-5.6	123.1	123.1	37.0	110.8	31.2	98.5	25.9	86.2	21.3	73.9	17.2	61.6	13.6	49.3	10.6	36.9	8.22
-7.0	-7.6	117.5	117.5	36.7	105.7	30.9	94.0	25.7	82.2	21.1	70.5	17.0	58.7	13.5	47.0	10.6	35.2	8.15
-10	-10.5	109.3	109.3	36.3	98.3	30.6	87.4	25.5	76.5	20.9	65.6	16.8	54.6	13.4	43.7	10.4	32.8	8.06
-14.5	-15.0	96.5	96.5	35.6	86.9	30.1	77.2	25.0	67.6	20.5	57.9	16.6	48.3	13.1	38.6	10.3	29.0	7.92

TC : Total Capacity PI : Power Input
 Indoor air temperature conditions : 20.0 °C dry-bulb



MMY-AP5216HT8P (52HP, 146.0kW system)

Cooling			Compressor + Outdoor Fan Power consumption (kW)															
Outdoor Unit Dry-Bulb (°C)		Outdoor Unit 100% Cooling Capacity (kW)	100%		90%		80%		70%		60%		50%		40%		30%	
			TC (kW)	PI (kW)	TC (kW)	PI (kW)	TC (kW)	PI (kW)	TC (kW)	PI (kW)	TC (kW)	PI (kW)	TC (kW)	PI (kW)	TC (kW)	PI (kW)	TC (kW)	PI (kW)
40		135.9	135.9	48.6	122.3	39.8	108.7	32.0	95.1	25.1	81.5	19.1	67.9	14.0	54.3	9.87	40.8	6.65
39		138.0	138.0	47.9	124.2	39.3	110.4	31.5	96.6	24.7	82.8	18.8	69.0	13.8	55.2	9.73	41.4	6.55
37		142.2	142.2	46.4	128.0	38.1	113.7	30.6	99.5	24.0	85.3	18.2	71.1	13.4	56.9	9.43	42.7	6.36
35		146.0	146.0	45.1	131.4	36.9	116.8	29.6	102.2	23.2	87.6	17.7	73.0	13.0	58.4	9.14	43.8	6.16
33		146.0	146.0	41.6	131.4	34.1	116.8	27.4	102.2	21.5	87.6	16.4	73.0	12.1	58.4	8.53	43.8	5.78
31		146.0	146.0	38.6	131.4	31.6	116.8	25.5	102.2	20.0	87.6	15.3	73.0	11.3	58.4	7.98	43.8	5.44
30		146.0	146.0	37.2	131.4	30.5	116.8	24.5	102.2	19.3	87.6	14.7	73.0	10.9	58.4	7.73	43.8	5.28
29		146.0	146.0	35.9	131.4	29.4	116.8	23.7	102.2	18.6	87.6	14.2	73.0	10.5	58.4	7.48	43.8	5.13
27		146.0	146.0	33.4	131.4	27.4	116.8	22.1	102.2	17.4	87.6	13.3	73.0	9.85	58.4	7.03	43.8	4.83
25		146.0	146.0	31.2	131.4	25.6	116.8	20.6	102.2	16.2	87.6	12.4	73.0	9.23	58.4	6.60	43.8	4.56
23		146.0	146.0	29.8	131.4	24.5	116.8	19.7	102.2	15.5	87.6	11.9	73.0	8.85	58.4	6.34	43.8	4.40
21		146.0	146.0	29.1	131.4	23.9	116.8	19.3	102.2	15.2	87.6	11.7	73.0	8.68	58.4	6.24	43.8	4.34
20		146.0	146.0	28.8	131.4	23.7	116.8	19.1	102.2	15.1	87.6	11.6	73.0	8.61	58.4	6.19	43.8	4.31
19		146.0	146.0	28.5	131.4	23.5	116.8	18.9	102.2	14.9	87.6	11.5	73.0	8.54	58.4	6.15	43.8	4.29
17		146.0	146.0	28.1	131.4	23.1	116.8	18.6	102.2	14.7	87.6	11.3	73.0	8.42	58.4	6.07	43.8	4.24
15		146.0	146.0	27.6	131.4	22.7	116.8	18.4	102.2	14.5	87.6	11.15	73.0	8.32	58.4	6.00	43.8	4.21

TC : Total Capacity PI : Power Input
 Indoor air temperature conditions : 27.0 °C dry-bulb / 19.0 °C wet-bulb

Heating			Compressor + Outdoor Fan Power consumption (kW)															
Outdoor Unit		Outdoor Unit 100% Cooling Capacity (kW)	100%		90%		80%		70%		60%		50%		40%		30%	
Dry-Bulb (°C)	Wet-Bulb (°C)		TC (kW)	PI (kW)	TC (kW)	PI (kW)	TC (kW)	PI (kW)	TC (kW)	PI (kW)	TC (kW)	PI (kW)	TC (kW)	PI (kW)	TC (kW)	PI (kW)	TC (kW)	PI (kW)
15.0	13.7	163.0	163.0	35.1	146.7	29.8	130.4	25.0	114.1	20.7	97.8	16.8	81.5	13.5	65.2	10.7	48.9	8.35
13.0	11.8	163.0	163.0	36.5	146.7	30.9	130.4	25.9	114.1	21.4	97.8	17.4	81.5	13.9	65.2	10.9	48.9	8.49
11.0	9.8	163.0	163.0	38.1	146.7	32.2	130.4	26.9	114.1	22.2	97.8	18.0	81.5	14.3	65.2	11.2	48.9	8.66
9.0	7.9	163.0	163.0	39.7	146.7	33.6	130.4	28.0	114.1	23.0	97.8	18.6	81.5	14.8	65.2	11.5	48.9	8.82
7.0	6.0	163.0	163.0	41.5	146.7	35.0	130.4	29.2	114.1	23.9	97.8	19.3	81.5	15.2	65.2	11.8	48.9	9.01
5.0	4.1	157.2	157.2	41.2	141.4	34.8	125.7	28.9	110.0	23.7	94.3	19.1	78.6	15.1	62.9	11.7	47.1	8.94
3.0	2.2	151.3	151.3	40.9	136.2	34.5	121.1	28.7	105.9	23.5	90.8	19.0	75.7	15.0	60.5	11.6	45.4	8.87
0.0	-0.7	142.4	142.4	40.4	128.2	34.1	113.9	28.4	99.7	23.3	85.4	18.7	71.2	14.8	57.0	11.5	42.7	8.77
-3.0	-3.7	133.2	133.2	39.9	119.9	33.7	106.6	28.0	93.2	23.0	79.9	18.5	66.6	14.6	53.3	11.4	40.0	8.66
-5.0	-5.6	127.4	127.4	39.6	114.6	33.4	101.9	27.8	89.2	22.8	76.4	18.4	63.7	14.5	50.9	11.3	38.2	8.59
-7.0	-7.6	121.2	121.2	39.2	109.1	33.1	97.0	27.6	84.9	22.6	72.7	18.2	60.6	14.4	48.5	11.2	36.4	8.52
-10	-10.5	112.3	112.3	38.8	101.1	32.7	89.8	27.2	78.6	22.3	67.4	18.0	56.2	14.2	44.9	11.0	33.7	8.41
-14.5	-15.0	98.5	98.5	38.0	88.6	32.1	78.8	26.7	68.9	21.9	59.1	17.6	49.2	14.0	39.4	10.8	29.5	8.25

TC : Total Capacity PI : Power Input
 Indoor air temperature conditions : 20.0 °C dry-bulb



MMY-AP5416HT8P (54HP, 151.5kW system)

Cooling			Compressor + Outdoor Fan Power consumption (kW)															
Outdoor Unit Dry-Bulb (°C)		Outdoor Unit 100% Cooling Capacity (kW)	100%		90%		80%		70%		60%		50%		40%		30%	
			TC (kW)	PI (kW)	TC (kW)	PI (kW)	TC (kW)	PI (kW)	TC (kW)	PI (kW)	TC (kW)	PI (kW)	TC (kW)	PI (kW)	TC (kW)	PI (kW)	TC (kW)	PI (kW)
40		141.0	141.0	52.1	126.9	42.6	112.8	34.2	98.7	26.8	84.6	20.3	70.5	14.8	56.4	10.4	42.3	6.89
39		143.2	143.2	51.3	128.9	42.0	114.6	33.7	100.3	26.4	85.9	20.0	71.6	14.6	57.3	10.2	43.0	6.79
37		147.5	147.5	49.7	132.8	40.7	118.0	32.7	103.3	25.6	88.5	19.4	73.8	14.2	59.0	9.91	44.3	6.58
35		151.5	151.5	48.2	136.4	39.5	121.2	31.7	106.1	24.8	90.9	18.8	75.8	13.7	60.6	9.60	45.5	6.38
33		151.5	151.5	44.5	136.4	36.5	121.2	29.3	106.1	22.9	90.9	17.4	75.8	12.8	60.6	8.95	45.5	5.98
31		151.5	151.5	41.3	136.4	33.9	121.2	27.2	106.1	21.3	90.9	16.2	75.8	11.9	60.6	8.37	45.5	5.62
30		151.5	151.5	39.8	136.4	32.6	121.2	26.2	106.1	20.6	90.9	15.7	75.8	11.5	60.6	8.10	45.5	5.45
29		151.5	151.5	38.4	136.4	31.5	121.2	25.3	106.1	19.8	90.9	15.1	75.8	11.1	60.6	7.84	45.5	5.29
27		151.5	151.5	35.8	136.4	29.3	121.2	23.6	106.1	18.5	90.9	14.1	75.8	10.4	60.6	7.35	45.5	4.98
25		151.5	151.5	33.4	136.4	27.4	121.2	22.0	106.1	17.3	90.9	13.2	75.8	9.74	60.6	6.91	45.5	4.70
23		151.5	151.5	31.8	136.4	26.1	121.2	21.0	106.1	16.5	90.9	12.6	75.8	9.33	60.6	6.63	45.5	4.52
21		151.5	151.5	31.1	136.4	25.6	121.2	20.6	106.1	16.2	90.9	12.4	75.8	9.16	60.6	6.52	45.5	4.46
20		151.5	151.5	30.8	136.4	25.3	121.2	20.4	106.1	16.0	90.9	12.3	75.8	9.08	60.6	6.47	45.5	4.43
19		151.5	151.5	30.5	136.4	25.1	121.2	20.2	106.1	15.9	90.9	12.2	75.8	9.01	60.6	6.42	45.5	4.41
17		151.5	151.5	30.0	136.4	24.7	121.2	19.9	106.1	15.6	90.9	12.0	75.8	8.88	60.6	6.34	45.5	4.36
15		151.5	151.5	29.6	136.4	24.3	121.2	19.6	106.1	15.4	90.9	11.8	75.8	8.77	60.6	6.27	45.5	4.32

TC : Total Capacity PI : Power Input
 Indoor air temperature conditions : 27.0 °C dry-bulb / 19.0 °C wet-bulb

Heating			Compressor + Outdoor Fan Power consumption (kW)															
Outdoor Unit		Outdoor Unit 100% Cooling Capacity (kW)	100%		90%		80%		70%		60%		50%		40%		30%	
Dry-Bulb (°C)	Wet-Bulb (°C)		TC (kW)	PI (kW)	TC (kW)	PI (kW)	TC (kW)	PI (kW)	TC (kW)	PI (kW)	TC (kW)	PI (kW)	TC (kW)	PI (kW)	TC (kW)	PI (kW)	TC (kW)	PI (kW)
15.0	13.7	164.0	164.0	35.2	147.6	29.9	131.2	25.1	114.8	20.7	98.4	16.9	82.0	13.6	65.6	10.8	49.2	8.41
13.0	11.8	164.0	164.0	36.6	147.6	31.0	131.2	26.0	114.8	21.4	98.4	17.4	82.0	14.0	65.6	11.0	49.2	8.56
11.0	9.8	164.0	164.0	38.2	147.6	32.3	131.2	27.0	114.8	22.2	98.4	18.0	82.0	14.4	65.6	11.3	49.2	8.72
9.0	7.9	164.0	164.0	39.8	147.6	33.7	131.2	28.1	114.8	23.1	98.4	18.7	82.0	14.8	65.6	11.6	49.2	8.89
7.0	6.0	164.0	164.0	41.6	147.6	35.1	131.2	29.2	114.8	24.0	98.4	19.3	82.0	15.3	65.6	11.9	49.2	9.08
5.0	4.1	158.1	158.1	41.3	142.3	34.8	126.5	29.0	110.7	23.8	94.9	19.2	79.1	15.2	63.2	11.8	47.4	9.01
3.0	2.2	152.3	152.3	41.0	137.0	34.6	121.8	28.8	106.6	23.6	91.4	19.0	76.1	15.1	60.9	11.7	45.7	8.94
0.0	-0.7	143.3	143.3	40.5	129.0	34.2	114.6	28.5	100.3	23.3	86.0	18.8	71.6	14.9	57.3	11.6	43.0	8.83
-3.0	-3.7	134.0	134.0	40.0	120.6	33.7	107.2	28.1	93.8	23.1	80.4	18.6	67.0	14.7	53.6	11.4	40.2	8.72
-5.0	-5.6	128.1	128.1	39.7	115.3	33.5	102.5	27.9	89.7	22.9	76.9	18.4	64.1	14.6	51.3	11.3	38.4	8.66
-7.0	-7.6	122.0	122.0	39.3	109.8	33.2	97.6	27.6	85.4	22.7	73.2	18.3	61.0	14.5	48.8	11.2	36.6	8.58
-10	-10.5	113.0	113.0	38.8	101.7	32.8	90.4	27.3	79.1	22.4	67.8	18.1	56.5	14.3	45.2	11.1	33.9	8.48
-14.5	-15.0	99.1	99.1	38.1	89.2	32.2	79.3	26.8	69.4	22.0	59.5	17.7	49.5	14.0	39.6	10.9	29.7	8.31

TC : Total Capacity PI : Power Input
 Indoor air temperature conditions : 20.0 °C dry-bulb



MMY-AP5616HT8P (56HP, 157.0kW system)

Cooling			Compressor + Outdoor Fan Power consumption (kW)															
Outdoor Unit Dry-Bulb (°C)		Outdoor Unit 100% Cooling Capacity (kW)	100%		90%		80%		70%		60%		50%		40%		30%	
			TC (kW)	PI (kW)	TC (kW)	PI (kW)	TC (kW)	PI (kW)	TC (kW)	PI (kW)	TC (kW)	PI (kW)	TC (kW)	PI (kW)	TC (kW)	PI (kW)	TC (kW)	PI (kW)
40		146.1	146.1	53.1	131.5	43.4	116.9	34.8	102.3	27.2	87.7	20.6	73.1	15.1	58.4	10.7	43.8	7.26
39		148.4	148.4	52.4	133.6	42.8	118.8	34.3	103.9	26.8	89.1	20.3	74.2	14.9	59.4	10.5	44.5	7.15
37		152.9	152.9	50.8	137.6	41.5	122.3	33.2	107.0	25.9	91.7	19.7	76.4	14.4	61.2	10.2	45.9	6.93
35		157.0	157.0	49.4	141.3	40.2	125.6	32.2	109.9	25.1	94.2	19.1	78.5	14.0	62.8	9.86	47.1	6.71
33		157.0	157.0	45.4	141.3	37.2	125.6	29.8	109.9	23.3	94.2	17.7	78.5	13.0	62.8	9.21	47.1	6.31
31		157.0	157.0	42.1	141.3	34.5	125.6	27.6	109.9	21.6	94.2	16.5	78.5	12.12	62.8	8.62	47.1	5.95
30		157.0	157.0	40.6	141.3	33.2	125.6	26.6	109.9	20.9	94.2	15.9	78.5	11.72	62.8	8.35	47.1	5.78
29		157.0	157.0	39.1	141.3	32.0	125.6	25.7	109.9	20.1	94.2	15.4	78.5	11.33	62.8	8.09	47.1	5.61
27		157.0	157.0	36.4	141.3	29.8	125.6	24.0	109.9	18.8	94.2	14.3	78.5	10.61	62.8	7.60	47.1	5.30
25		157.0	157.0	34.0	141.3	27.8	125.6	22.4	109.9	17.6	94.2	13.4	78.5	9.94	62.8	7.14	47.1	5.00
23		157.0	157.0	32.4	141.3	26.6	125.6	21.4	109.9	16.8	94.2	12.8	78.5	9.53	62.8	6.86	47.1	4.83
21		157.0	157.0	31.7	141.3	26.0	125.6	20.9	109.9	16.4	94.2	12.6	78.5	9.36	62.8	6.75	47.1	4.77
20		157.0	157.0	31.4	141.3	25.7	125.6	20.7	109.9	16.3	94.2	12.5	78.5	9.28	62.8	6.70	47.1	4.74
19		157.0	157.0	31.1	141.3	25.5	125.6	20.5	109.9	16.1	94.2	12.4	78.5	9.21	62.8	6.66	47.1	4.72
17		157.0	157.0	30.6	141.3	25.1	125.6	20.2	109.9	15.9	94.2	12.2	78.5	9.08	62.8	6.58	47.1	4.67
15		157.0	157.0	30.1	141.3	24.7	125.6	19.9	109.9	15.7	94.2	12.0	78.5	8.97	62.8	6.51	47.1	4.63

TC : Total Capacity PI : Power Input
 Indoor air temperature conditions : 27.0 °C dry-bulb / 19.0 °C wet-bulb

Heating			Compressor + Outdoor Fan Power consumption (kW)															
Outdoor Unit Dry-Bulb (°C) / Wet-Bulb (°C)		Outdoor Unit 100% Cooling Capacity (kW)	100%		90%		80%		70%		60%		50%		40%		30%	
			TC (kW)	PI (kW)	TC (kW)	PI (kW)	TC (kW)	PI (kW)	TC (kW)	PI (kW)	TC (kW)	PI (kW)	TC (kW)	PI (kW)	TC (kW)	PI (kW)	TC (kW)	PI (kW)
15.0	13.7	176.0	176.0	38.7	158.4	33.0	140.8	27.8	123.2	23.1	105.6	18.8	88.0	15.0	70.4	11.6	52.8	8.77
13.0	11.8	176.0	176.0	40.2	158.4	34.3	140.8	28.8	123.2	23.9	105.6	19.4	88.0	15.4	70.4	11.9	52.8	8.96
11.0	9.8	176.0	176.0	41.9	158.4	35.6	140.8	29.9	123.2	24.7	105.6	20.1	88.0	15.9	70.4	12.3	52.8	9.17
9.0	7.9	176.0	176.0	43.6	158.4	37.1	140.8	31.1	123.2	25.7	105.6	20.8	88.0	16.4	70.4	12.6	52.8	9.39
7.0	6.0	176.0	176.0	45.5	158.4	38.6	140.8	32.3	123.2	26.6	105.6	21.5	88.0	17.0	70.4	13.0	52.8	9.62
5.0	4.1	169.7	169.7	45.1	152.7	38.3	135.8	32.1	118.8	26.4	101.8	21.4	84.8	16.8	67.9	12.9	50.9	9.55
3.0	2.2	163.4	163.4	44.8	147.1	38.0	130.7	31.9	114.4	26.2	98.0	21.2	81.7	16.7	65.4	12.8	49.0	9.47
0.0	-0.7	153.8	153.8	44.3	138.4	37.6	123.0	31.5	107.6	25.9	92.3	20.9	76.9	16.5	61.5	12.7	46.1	9.36
-3.0	-3.7	143.8	143.8	43.7	129.4	37.1	115.1	31.1	100.7	25.6	86.3	20.7	71.9	16.3	57.5	12.5	43.1	9.25
-5.0	-5.6	137.5	137.5	43.4	123.8	36.8	110.0	30.8	96.3	25.4	82.5	20.5	68.8	16.2	55.0	12.4	41.3	9.17
-7.0	-7.6	130.9	130.9	43.0	117.8	36.5	104.7	30.6	91.6	25.2	78.5	20.3	65.4	16.1	52.4	12.3	39.3	9.10
-10	-10.5	121.3	121.3	42.5	109.1	36.1	97.0	30.2	84.9	24.9	72.8	20.1	60.6	15.9	48.5	12.1	36.4	8.99
-14.5	-15.0	106.3	106.3	41.7	95.7	35.4	85.1	29.6	74.4	24.4	63.8	19.7	53.2	15.5	42.5	11.9	31.9	8.81

TC : Total Capacity PI : Power Input
 Indoor air temperature conditions : 20.0 °C dry-bulb



MMY-AP5816HT8P (58HP, 162.5kW system)

Cooling			Compressor + Outdoor Fan Power consumption (kW)															
Outdoor Unit		Outdoor Unit 100% Cooling Capacity (kW)	100%		90%		80%		70%		60%		50%		40%		30%	
Dry-Bulb (°C)			TC (kW)	PI (kW)	TC (kW)	PI (kW)	TC (kW)	PI (kW)	TC (kW)	PI (kW)	TC (kW)	PI (kW)	TC (kW)	PI (kW)	TC (kW)	PI (kW)	TC (kW)	PI (kW)
40		151.2	151.2	56.6	136.1	46.2	121.0	37.0	105.9	27.2	90.7	21.8	75.6	15.9	60.5	11.2	45.4	7.50
39		153.6	153.6	55.8	138.3	45.5	122.9	36.4	107.6	26.8	92.2	21.5	76.8	15.7	61.5	11.0	46.1	7.38
37		158.2	158.2	54.1	142.4	44.2	126.6	35.3	110.8	25.9	94.9	20.9	79.1	15.2	63.3	10.7	47.5	7.16
35		162.5	162.5	52.5	146.3	42.8	130.0	34.2	113.8	25.1	97.5	20.2	81.3	14.7	65.0	10.3	48.8	6.94
33		162.5	162.5	48.4	146.3	39.5	130.0	31.6	113.8	23.3	97.5	18.7	81.3	13.7	65.0	9.63	48.8	6.51
31		162.5	162.5	44.8	146.3	36.7	130.0	29.4	113.8	21.6	97.5	17.4	81.3	12.8	65.0	9.01	48.8	6.13
30		162.5	162.5	43.2	146.3	35.3	130.0	28.3	113.8	20.9	97.5	16.8	81.3	12.3	65.0	8.72	48.8	5.95
29		162.5	162.5	41.7	146.3	34.1	130.0	27.3	113.8	20.1	97.5	16.2	81.3	11.9	65.0	8.44	48.8	5.78
27		162.5	162.5	38.8	146.3	31.7	130.0	25.5	113.8	18.8	97.5	15.2	81.3	11.2	65.0	7.92	48.8	5.45
25		162.5	162.5	36.2	146.3	29.6	130.0	23.8	113.8	17.6	97.5	14.2	81.3	10.5	65.0	7.44	48.8	5.14
23		162.5	162.5	34.5	146.3	28.3	130.0	22.7	113.8	16.8	97.5	13.6	81.3	10.0	65.0	7.15	48.8	4.96
21		162.5	162.5	33.8	146.3	27.6	130.0	22.2	113.8	16.4	97.5	13.3	81.3	9.83	65.0	7.03	48.8	4.89
20		162.5	162.5	33.4	146.3	27.4	130.0	22.0	113.8	16.3	97.5	13.2	81.3	9.75	65.0	6.98	48.8	4.86
19		162.5	162.5	33.1	146.3	27.1	130.0	21.8	113.8	16.1	97.5	13.1	81.3	9.67	65.0	6.93	48.8	4.84
17		162.5	162.5	32.5	146.3	26.6	130.0	21.4	113.8	15.9	97.5	12.9	81.3	9.53	65.0	6.84	48.8	4.79
15		162.5	162.5	32.0	146.3	26.3	130.0	21.1	113.8	15.7	97.5	12.7	81.3	9.41	65.0	6.77	48.8	4.75

TC : Total Capacity PI : Power Input
Indoor air temperature conditions : 27.0 °C dry-bulb / 19.0 °C wet-bulb

Heating			Compressor + Outdoor Fan Power consumption (kW)															
Outdoor Unit		Outdoor Unit 100% Cooling Capacity (kW)	100%		90%		80%		70%		60%		50%		40%		30%	
Dry-Bulb (°C)	Wet-Bulb (°C)		TC (kW)	PI (kW)	TC (kW)	PI (kW)	TC (kW)	PI (kW)	TC (kW)	PI (kW)	TC (kW)	PI (kW)	TC (kW)	PI (kW)	TC (kW)	PI (kW)	TC (kW)	PI (kW)
15.0	13.7	177.0	177.0	38.8	159.3	33.1	141.6	27.9	123.9	23.1	106.2	18.9	88.5	15.1	70.8	11.7	53.1	8.84
13.0	11.8	177.0	177.0	40.3	159.3	34.3	141.6	28.9	123.9	23.9	106.2	19.5	88.5	15.5	70.8	12.0	53.1	9.03
11.0	9.8	177.0	177.0	42.0	159.3	35.7	141.6	30.0	123.9	24.8	106.2	20.1	88.5	16.0	70.8	12.4	53.1	9.24
9.0	7.9	177.0	177.0	43.7	159.3	37.2	141.6	31.2	123.9	25.7	106.2	20.8	88.5	16.5	70.8	12.7	53.1	9.45
7.0	6.0	177.0	177.0	45.6	159.3	38.7	141.6	32.4	123.9	26.7	106.2	21.6	88.5	17.0	70.8	13.1	53.1	9.69
5.0	4.1	170.7	170.7	45.2	153.6	38.4	136.5	32.2	119.5	26.5	102.4	21.4	85.3	16.9	68.3	13.0	51.2	9.61
3.0	2.2	164.3	164.3	44.9	147.9	38.1	131.5	31.9	115.0	26.3	98.6	21.3	82.2	16.8	65.7	12.9	49.3	9.54
0.0	-0.7	154.6	154.6	44.4	139.2	37.7	123.7	31.6	108.3	26.0	92.8	21.0	77.3	16.6	61.9	12.7	46.4	9.43
-3.0	-3.7	144.6	144.6	43.8	130.2	37.2	115.7	31.2	101.2	25.7	86.8	20.8	72.3	16.4	57.9	12.6	43.4	9.31
-5.0	-5.6	138.3	138.3	43.5	124.5	36.9	110.6	30.9	96.8	25.5	83.0	20.6	69.2	16.3	55.3	12.5	41.5	9.24
-7.0	-7.6	131.6	131.6	43.1	118.5	36.6	105.3	30.7	92.1	25.3	79.0	20.4	65.8	16.1	52.7	12.4	39.5	9.16
-10	-10.5	122.0	122.0	42.6	109.8	36.2	97.6	30.3	85.4	25.0	73.2	20.2	61.0	15.9	48.8	12.2	36.6	9.05
-14.5	-15.0	106.9	106.9	41.8	96.3	35.5	85.6	29.7	74.9	24.5	64.2	19.8	53.5	15.6	42.8	12.0	32.1	8.87

TC : Total Capacity PI : Power Input
Indoor air temperature conditions : 20.0 °C dry-bulb



MMY-AP6016HT8P (60HP, 168.0kW system)

Cooling			Compressor + Outdoor Fan Power consumption (kW)															
Outdoor Unit Dry-Bulb (°C)		Outdoor Unit 100% Cooling Capacity (kW)	100%		90%		80%		70%		60%		50%		40%		30%	
			TC (kW)	PI (kW)	TC (kW)	PI (kW)	TC (kW)	PI (kW)	TC (kW)	PI (kW)	TC (kW)	PI (kW)	TC (kW)	PI (kW)	TC (kW)	PI (kW)	TC (kW)	PI (kW)
40		156.3	156.3	60.1	140.7	49.0	125.1	39.2	109.4	30.5	93.8	23.0	78.2	16.8	62.5	11.7	46.9	7.73
39		158.8	158.8	59.2	143.0	48.3	127.1	38.6	111.2	30.1	95.3	22.7	79.4	16.5	63.5	11.5	47.7	7.62
37		163.6	163.6	57.4	147.2	46.8	130.9	37.4	114.5	29.2	98.2	22.0	81.8	16.0	65.4	11.1	49.1	7.39
35		168.0	168.0	55.6	151.2	45.4	134.4	36.3	117.6	28.2	100.8	21.3	84.0	15.5	67.2	10.8	50.4	7.16
33		168.0	168.0	51.3	151.2	41.9	134.4	33.5	117.6	26.1	100.8	19.8	84.0	14.4	67.2	10.1	50.4	6.71
31		168.0	168.0	47.6	151.2	38.9	134.4	31.1	117.6	24.3	100.8	18.4	84.0	13.4	67.2	9.40	50.4	6.31
30		168.0	168.0	45.8	151.2	37.5	134.4	30.0	117.6	23.4	100.8	17.7	84.0	13.0	67.2	9.09	50.4	6.12
29		168.0	168.0	44.2	151.2	36.1	134.4	28.9	117.6	22.6	100.8	17.1	84.0	12.5	67.2	8.80	50.4	5.94
27		168.0	168.0	41.2	151.2	33.7	134.4	27.0	117.6	21.1	100.8	16.0	84.0	11.7	67.2	8.25	50.4	5.60
25		168.0	168.0	38.4	151.2	31.4	134.4	25.2	117.6	19.7	100.8	14.9	84.0	11.0	67.2	7.75	50.4	5.28
23		168.0	168.0	36.6	151.2	30.0	134.4	24.0	117.6	18.8	100.8	14.3	84.0	10.5	67.2	7.44	50.4	5.09
21		168.0	168.0	35.8	151.2	29.3	134.4	23.5	117.6	18.4	100.8	14.0	84.0	10.3	67.2	7.31	50.4	5.02
20		168.0	168.0	35.4	151.2	29.0	134.4	23.3	117.6	18.2	100.8	13.9	84.0	10.2	67.2	7.25	50.4	4.98
19		168.0	168.0	35.1	151.2	28.7	134.4	23.0	117.6	18.1	100.8	13.8	84.0	10.1	67.2	7.20	50.4	4.96
17		168.0	168.0	34.5	151.2	28.2	134.4	22.7	117.6	17.8	100.8	13.5	84.0	9.99	67.2	7.11	50.4	4.90
15		168.0	168.0	34.0	151.2	27.8	134.4	22.3	117.6	17.5	100.8	13.4	84.0	9.86	67.2	7.03	50.4	4.86

TC : Total Capacity PI : Power Input
 Indoor air temperature conditions : 27.0 °C dry-bulb / 19.0 °C wet-bulb

Heating			Compressor + Outdoor Fan Power consumption (kW)															
Outdoor Unit Dry-Bulb (°C) / Wet-Bulb (°C)		Outdoor Unit 100% Cooling Capacity (kW)	100%		90%		80%		70%		60%		50%		40%		30%	
			TC (kW)	PI (kW)	TC (kW)	PI (kW)	TC (kW)	PI (kW)	TC (kW)	PI (kW)	TC (kW)	PI (kW)	TC (kW)	PI (kW)	TC (kW)	PI (kW)	TC (kW)	PI (kW)
15.0	13.7	178.0	178.0	38.9	160.2	33.2	142.4	28.0	124.6	23.2	106.8	18.9	89.0	15.1	71.2	11.8	53.4	8.91
13.0	11.8	178.0	178.0	40.4	160.2	34.4	142.4	29.0	124.6	24.0	106.8	19.5	89.0	15.6	71.2	12.1	53.4	9.09
11.0	9.8	178.0	178.0	42.1	160.2	35.8	142.4	30.1	124.6	24.9	106.8	20.2	89.0	16.1	71.2	12.4	53.4	9.31
9.0	7.9	178.0	178.0	43.8	160.2	37.3	142.4	31.3	124.6	25.8	106.8	20.9	89.0	16.6	71.2	12.8	53.4	9.52
7.0	6.0	178.0	178.0	45.7	160.2	38.8	142.4	32.5	124.6	26.8	106.8	21.7	89.0	17.1	71.2	13.1	53.4	9.76
5.0	4.1	171.6	171.6	45.3	154.5	38.5	137.3	32.3	120.1	26.6	103.0	21.5	85.8	17.0	68.6	13.0	51.5	9.68
3.0	2.2	165.2	165.2	45.0	148.7	38.2	132.2	32.0	115.7	26.4	99.1	21.3	82.6	16.9	66.1	12.9	49.6	9.61
0.0	-0.7	155.5	155.5	44.5	140.0	37.8	124.4	31.6	108.9	26.1	93.3	21.1	77.8	16.7	62.2	12.8	46.7	9.49
-3.0	-3.7	145.5	145.5	43.9	130.9	37.3	116.4	31.3	101.8	25.8	87.3	20.8	72.7	16.5	58.2	12.6	43.6	9.38
-5.0	-5.6	139.1	139.1	43.6	125.2	37.0	111.3	31.0	97.4	25.6	83.4	20.7	69.5	16.3	55.6	12.5	41.7	9.30
-7.0	-7.6	132.4	132.4	43.2	119.1	36.7	105.9	30.8	92.7	25.3	79.4	20.5	66.2	16.2	52.9	12.4	39.7	9.22
-10	-10.5	122.6	122.6	42.7	110.4	36.3	98.1	30.4	85.9	25.0	73.6	20.2	61.3	16.0	49.1	12.3	36.8	9.11
-14.5	-15.0	107.5	107.5	41.9	96.8	35.6	86.0	29.8	75.3	24.6	64.5	19.9	53.8	15.7	43.0	12.0	32.3	8.94

TC : Total Capacity PI : Power Input
 Indoor air temperature conditions : 20.0 °C dry-bulb



MMY-AP2026HT8P (20HP, 56kW system)

Cooling			Compressor + Outdoor Fan Power consumption (kW)															
Outdoor Unit Dry-Bulb (°C)		Outdoor Unit 100% Cooling Capacity (kW)	100%		90%		80%		70%		60%		50%		40%		30%	
			TC (kW)	PI (kW)	TC (kW)	PI (kW)	TC (kW)	PI (kW)	TC (kW)	PI (kW)	TC (kW)	PI (kW)	TC (kW)	PI (kW)	TC (kW)	PI (kW)	TC (kW)	PI (kW)
40		52.1	52.1	15.7	46.9	12.9	41.7	10.4	36.5	8.22	31.3	6.38	26.1	4.87	20.8	3.67	15.6	2.80
39		52.9	52.9	15.5	47.7	12.7	42.4	10.2	37.1	8.10	31.8	6.29	26.5	4.79	21.2	3.62	15.9	2.76
37		54.5	54.5	15.0	49.1	12.3	43.6	9.92	38.2	7.85	32.7	6.10	27.3	4.65	21.8	3.51	16.4	2.68
35		56.0	56.0	14.5	50.4	11.9	44.8	9.61	39.2	7.61	33.6	5.91	28.0	4.50	22.4	3.40	16.8	2.59
33		56.0	56.0	13.4	50.4	11.0	44.8	8.91	39.2	7.07	33.6	5.50	28.0	4.21	22.4	3.20	16.8	2.46
31		56.0	56.0	12.4	50.4	10.2	44.8	8.28	39.2	6.58	33.6	5.14	28.0	3.95	22.4	3.02	16.8	2.34
30		56.0	56.0	12.0	50.4	9.87	44.8	7.99	39.2	6.36	33.6	4.97	28.0	3.83	22.4	2.94	16.8	2.29
29		56.0	56.0	11.6	50.4	9.53	44.8	7.72	39.2	6.15	33.6	4.81	28.0	3.71	22.4	2.85	16.8	2.23
27		56.0	56.0	10.8	50.4	8.89	44.8	7.21	39.2	5.75	33.6	4.51	28.0	3.49	22.4	2.70	16.8	2.12
25		56.0	56.0	10.1	50.4	8.30	44.8	6.74	39.2	5.39	33.6	4.24	28.0	3.29	22.4	2.55	16.8	2.02
23		56.0	56.0	9.62	50.4	7.93	44.8	6.45	39.2	5.16	33.6	4.06	28.0	3.17	22.4	2.46	16.8	1.96
21		56.0	56.0	9.41	50.4	7.77	44.8	6.32	39.2	5.06	33.6	3.99	28.0	3.12	22.4	2.44	16.8	1.94
20		56.0	56.0	9.31	50.4	7.69	44.8	6.26	39.2	5.02	33.6	3.96	28.0	3.10	22.4	2.42	16.8	1.94
19		56.0	56.0	9.23	50.4	7.62	44.8	6.21	39.2	4.98	33.6	3.93	28.0	3.08	22.4	2.41	16.8	1.93
17		56.0	56.0	9.07	50.4	7.50	44.8	6.11	39.2	4.91	33.6	3.88	28.0	3.04	22.4	2.39	16.8	1.92
15		56.0	56.0	8.94	50.4	7.40	44.8	6.03	39.2	4.84	33.6	3.84	28.0	3.02	22.4	2.37	16.8	1.91

TC : Total Capacity PI : Power Input
 Indoor air temperature conditions : 27.0 °C dry-bulb / 19.0 °C wet-bulb

Heating			Compressor + Outdoor Fan Power consumption (kW)															
Outdoor Unit Dry-Bulb (°C) / Wet-Bulb (°C)		Outdoor Unit 100% Cooling Capacity (kW)	100%		90%		80%		70%		60%		50%		40%		30%	
			TC (kW)	PI (kW)	TC (kW)	PI (kW)	TC (kW)	PI (kW)	TC (kW)	PI (kW)	TC (kW)	PI (kW)	TC (kW)	PI (kW)	TC (kW)	PI (kW)	TC (kW)	PI (kW)
15.0	13.7	63.0	63.0	12.0	56.7	10.2	50.4	8.57	44.1	7.11	37.8	5.81	31.5	4.68	25.2	3.72	18.9	2.93
13.0	11.8	63.0	63.0	12.5	56.7	10.6	50.4	8.88	44.1	7.35	37.8	5.99	31.5	4.81	25.2	3.80	18.9	2.97
11.0	9.8	63.0	63.0	13.0	56.7	11.0	50.4	9.23	44.1	7.62	37.8	6.20	31.5	4.96	25.2	3.90	18.9	3.03
9.0	7.9	63.0	63.0	13.6	56.7	11.5	50.4	9.59	44.1	7.90	37.8	6.41	31.5	5.11	25.2	4.00	18.9	3.09
7.0	6.0	63.0	63.0	14.2	56.7	12.0	50.4	9.99	44.1	8.21	37.8	6.63	31.5	5.27	25.2	4.11	18.9	3.15
5.0	4.1	61.0	61.0	14.1	54.9	11.9	48.8	9.93	42.7	8.16	36.6	6.60	30.5	5.24	24.4	4.08	18.3	3.13
3.0	2.2	58.9	58.9	14.0	53.1	11.8	47.2	9.87	41.3	8.11	35.4	6.56	29.5	5.21	23.6	4.06	17.7	3.11
0.0	-0.7	55.9	55.9	13.9	50.3	11.7	44.7	9.78	39.1	8.04	33.5	6.50	27.9	5.16	22.3	4.02	16.8	3.09
-3.0	-3.7	52.7	52.7	13.7	47.4	11.6	42.1	9.69	36.9	7.97	31.6	6.44	26.3	5.11	21.1	3.99	15.8	3.06
-5.0	-5.6	50.6	50.6	13.7	45.6	11.6	40.5	9.64	35.4	7.92	30.4	6.40	25.3	5.08	20.3	3.96	15.2	3.04
-7.0	-7.6	48.5	48.5	13.6	43.6	11.5	38.8	9.58	33.9	7.87	29.1	6.36	24.2	5.05	19.4	3.94	14.5	3.02
-10	-10.5	45.4	45.4	13.5	40.9	11.4	36.3	9.49	31.8	7.80	27.2	6.30	22.7	5.01	18.2	3.90	13.6	2.99
-14.5	-15.0	40.6	40.6	13.3	36.5	11.2	32.5	9.35	28.4	7.69	24.4	6.22	20.3	4.93	16.2	3.85	12.18	2.95

TC : Total Capacity PI : Power Input
 Indoor air temperature conditions : 20.0 °C dry-bulb



MMY-AP2226HT8P (22HP, 61.5kW system)

Cooling			Compressor + Outdoor Fan Power consumption (kW)															
Outdoor Unit Dry-Bulb (°C)		Outdoor Unit 100% Cooling Capacity (kW)	100%		90%		80%		70%		60%		50%		40%		30%	
			TC (kW)	PI (kW)	TC (kW)	PI (kW)	TC (kW)	PI (kW)	TC (kW)	PI (kW)	TC (kW)	PI (kW)	TC (kW)	PI (kW)	TC (kW)	PI (kW)	TC (kW)	PI (kW)
40		57.2	57.2	18.0	51.5	14.8	45.8	12.0	40.1	9.50	34.3	7.34	28.6	5.52	22.9	4.04	17.2	2.91
39		58.2	58.2	17.7	52.3	14.6	46.5	11.8	40.7	9.36	34.9	7.23	29.1	5.44	23.3	3.98	17.4	2.86
37		59.9	59.9	17.2	53.9	14.2	47.9	11.5	41.9	9.07	35.9	7.01	29.9	5.28	24.0	3.86	18.0	2.78
35		61.5	61.5	16.7	55.4	13.7	49.2	11.1	43.1	8.79	36.9	6.79	30.8	5.11	24.6	3.74	18.5	2.69
33		61.5	61.5	15.4	55.4	12.7	49.2	10.3	43.1	8.16	36.9	6.32	30.8	4.77	24.6	3.51	18.5	2.54
31		61.5	61.5	14.3	55.4	11.8	49.2	9.57	43.1	7.60	36.9	5.90	30.8	4.46	24.6	3.30	18.5	2.40
30		61.5	61.5	13.8	55.4	11.4	49.2	9.24	43.1	7.34	36.9	5.70	30.8	4.32	24.6	3.20	18.5	2.34
29		61.5	61.5	13.3	55.4	11.0	49.2	8.92	43.1	7.09	36.9	5.51	30.8	4.19	24.6	3.11	18.5	2.28
27		61.5	61.5	12.4	55.4	10.3	49.2	8.33	43.1	6.63	36.9	5.16	30.8	3.93	24.6	2.93	18.5	2.15
25		61.5	61.5	11.6	55.4	9.59	49.2	7.79	43.1	6.21	36.9	4.84	30.8	3.69	24.6	2.76	18.5	2.04
23		61.5	61.5	11.1	55.4	9.16	49.2	7.45	43.1	5.94	36.9	4.64	30.8	3.55	24.6	2.66	18.5	1.97
21		61.5	61.5	10.8	55.4	8.97	49.2	7.30	43.1	5.83	36.9	4.56	30.8	3.49	24.6	2.62	18.5	1.95
20		61.5	61.5	10.7	55.4	8.88	49.2	7.23	43.1	5.78	36.9	4.52	30.8	3.46	24.6	2.60	18.5	1.94
19		61.5	61.5	10.6	55.4	8.81	49.2	7.17	43.1	5.73	36.9	4.49	30.8	3.44	24.6	2.59	18.5	1.94
17		61.5	61.5	10.5	55.4	8.66	49.2	7.06	43.1	5.64	36.9	4.42	30.8	3.40	24.6	2.56	18.5	1.93
15		61.5	61.5	10.3	55.4	8.54	49.2	6.96	43.1	5.57	36.9	4.37	30.8	3.36	24.6	2.54	18.5	1.93

TC : Total Capacity PI : Power Input
 Indoor air temperature conditions : 27.0 °C dry-bulb / 19.0 °C wet-bulb

Heating			Compressor + Outdoor Fan Power consumption (kW)															
Outdoor Unit Dry-Bulb (°C) / Wet-Bulb (°C)		Outdoor Unit 100% Cooling Capacity (kW)	100%		90%		80%		70%		60%		50%		40%		30%	
			TC (kW)	PI (kW)	TC (kW)	PI (kW)	TC (kW)	PI (kW)	TC (kW)	PI (kW)	TC (kW)	PI (kW)	TC (kW)	PI (kW)	TC (kW)	PI (kW)	TC (kW)	PI (kW)
15.0	13.7	69.0	69.0	13.9	62.1	11.8	55.2	9.96	48.3	8.26	41.4	6.74	34.5	5.39	27.6	4.21	20.7	3.21
13.0	11.8	69.0	69.0	14.4	62.1	12.3	55.2	10.3	48.3	8.54	41.4	6.95	34.5	5.54	27.6	4.32	20.7	3.27
11.0	9.8	69.0	69.0	15.0	62.1	12.8	55.2	10.7	48.3	8.86	41.4	7.19	34.5	5.72	27.6	4.44	20.7	3.35
9.0	7.9	69.0	69.0	15.6	62.1	13.3	55.2	11.1	48.3	9.19	41.4	7.44	34.5	5.90	27.6	4.56	20.7	3.42
7.0	6.0	69.0	69.0	16.3	62.1	13.8	55.2	11.6	48.3	9.54	41.4	7.71	34.5	6.09	27.6	4.69	20.7	3.50
5.0	4.1	66.6	66.6	16.2	60.0	13.7	53.3	11.5	46.6	9.47	40.0	7.66	33.3	6.05	26.7	4.66	20.0	3.48
3.0	2.2	64.3	64.3	16.1	57.9	13.7	51.4	11.4	45.0	9.41	38.6	7.60	32.1	6.01	25.7	4.63	19.3	3.46
0.0	-0.7	60.7	60.7	15.9	54.6	13.5	48.6	11.3	42.5	9.31	36.4	7.52	30.3	5.95	24.3	4.58	18.2	3.42
-3.0	-3.7	57.0	57.0	15.8	51.3	13.4	45.6	11.2	39.9	9.21	34.2	7.44	28.5	5.88	22.8	4.53	17.1	3.38
-5.0	-5.6	54.6	54.6	15.6	49.2	13.3	43.7	11.1	38.2	9.14	32.8	7.39	27.3	5.84	21.8	4.50	16.4	3.36
-7.0	-7.6	52.1	52.1	15.5	46.9	13.2	41.7	11.0	36.5	9.08	31.3	7.33	26.1	5.80	20.9	4.46	15.6	3.33
-10	-10.5	48.5	48.5	15.4	43.7	13.0	38.8	10.9	34.0	8.98	29.1	7.25	24.3	5.73	19.4	4.41	14.6	3.30
-14.5	-15.0	43.0	43.0	15.1	38.7	12.8	34.4	10.7	30.1	8.82	25.8	7.13	21.5	5.64	17.2	4.34	12.9	3.24

TC : Total Capacity PI : Power Input
 Indoor air temperature conditions : 20.0 °C dry-bulb



MMY-AP3626HT8P (36HP, 100.5kW system)

Cooling			Compressor + Outdoor Fan Power consumption (kW)															
Outdoor Unit Dry-Bulb (°C)		Outdoor Unit 100% Cooling Capacity (kW)	100%		90%		80%		70%		60%		50%		40%		30%	
			TC (kW)	PI (kW)	TC (kW)	PI (kW)	TC (kW)	PI (kW)	TC (kW)	PI (kW)	TC (kW)	PI (kW)	TC (kW)	PI (kW)	TC (kW)	PI (kW)	TC (kW)	PI (kW)
40		93.5	93.5	30.5	84.2	25.2	74.8	20.4	65.5	16.2	56.1	12.4	46.8	9.27	37.4	6.62	28.1	4.52
39		95.0	95.0	30.0	85.5	24.8	76.0	20.1	66.5	15.9	57.0	12.3	47.5	9.13	38.0	6.53	28.5	4.45
37		97.9	97.9	29.1	88.1	24.1	78.3	19.5	68.5	15.4	58.7	11.9	48.9	8.85	39.1	6.33	29.4	4.31
35		100.5	100.5	28.2	90.5	23.3	80.4	18.9	70.4	15.0	60.3	11.5	50.3	8.58	40.2	6.13	30.2	4.18
33		100.5	100.5	26.1	90.5	21.6	80.4	17.5	70.4	13.9	60.3	10.7	50.3	7.99	40.2	5.73	30.2	3.93
31		100.5	100.5	24.3	90.5	20.1	80.4	16.3	70.4	12.9	60.3	9.98	50.3	7.46	40.2	5.37	30.2	3.69
30		100.5	100.5	23.4	90.5	19.4	80.4	15.7	70.4	12.5	60.3	9.65	50.3	7.22	40.2	5.20	30.2	3.59
29		100.5	100.5	22.6	90.5	18.7	80.4	15.2	70.4	12.1	60.3	9.32	50.3	6.99	40.2	5.04	30.2	3.48
27		100.5	100.5	21.1	90.5	17.4	80.4	14.2	70.4	11.3	60.3	8.73	50.3	6.55	40.2	4.73	30.2	3.28
25		100.5	100.5	19.7	90.5	16.3	80.4	13.3	70.4	10.5	60.3	8.17	50.3	6.14	40.2	4.45	30.2	3.10
23		100.5	100.5	18.8	90.5	15.6	80.4	12.7	70.4	10.1	60.3	7.83	50.3	5.89	40.2	4.28	30.2	2.99
21		100.5	100.5	18.4	90.5	15.3	80.4	12.4	70.4	9.89	60.3	7.68	50.3	5.79	40.2	4.21	30.2	2.95
20		100.5	100.5	18.2	90.5	15.1	80.4	12.3	70.4	9.80	60.3	7.62	50.3	5.74	40.2	4.18	30.2	2.93
19		100.5	100.5	18.1	90.5	15.0	80.4	12.2	70.4	9.72	60.3	7.56	50.3	5.70	40.2	4.15	30.2	2.91
17		100.5	100.5	17.8	90.5	14.7	80.4	12.0	70.4	9.57	60.3	7.45	50.3	5.62	40.2	4.10	30.2	2.91
15		100.5	100.5	17.5	90.5	14.5	80.4	11.8	70.4	9.45	60.3	7.35	50.3	5.56	40.2	4.06	30.2	2.91

TC : Total Capacity PI : Power Input
 Indoor air temperature conditions : 27.0 °C dry-bulb / 19.0 °C wet-bulb

Heating			Compressor + Outdoor Fan Power consumption (kW)															
Outdoor Unit Dry-Bulb (°C) / Wet-Bulb (°C)		Outdoor Unit 100% Cooling Capacity (kW)	100%		90%		80%		70%		60%		50%		40%		30%	
			TC (kW)	PI (kW)	TC (kW)	PI (kW)	TC (kW)	PI (kW)	TC (kW)	PI (kW)	TC (kW)	PI (kW)	TC (kW)	PI (kW)	TC (kW)	PI (kW)	TC (kW)	PI (kW)
15.0	13.7	112.5	112.5	23.6	101.3	20.2	90.0	17.0	78.8	14.1	67.5	11.5	56.3	9.14	45.0	7.06	33.8	5.24
13.0	11.8	112.5	112.5	24.5	101.3	20.9	90.0	17.6	78.8	14.6	67.5	11.9	56.3	9.41	45.0	7.24	33.8	5.36
11.0	9.8	112.5	112.5	25.5	101.3	21.8	90.0	18.3	78.8	15.1	67.5	12.3	56.3	9.72	45.0	7.46	33.8	5.50
9.0	7.9	112.5	112.5	26.6	101.3	22.6	90.0	19.0	78.8	15.7	67.5	12.7	56.3	10.0	45.0	7.68	33.8	5.64
7.0	6.0	112.5	112.5	27.7	101.3	23.6	90.0	19.8	78.8	16.3	67.5	13.2	56.3	10.4	45.0	7.91	33.8	5.78
5.0	4.1	108.5	108.5	27.5	97.6	23.4	86.8	19.6	75.9	16.2	65.1	13.1	54.2	10.3	43.4	7.85	32.5	5.74
3.0	2.2	104.4	104.4	27.3	94.0	23.2	83.6	19.5	73.1	16.1	62.7	13.0	52.2	10.2	41.8	7.79	31.3	5.70
0.0	-0.7	98.3	98.3	27.0	88.5	22.9	78.6	19.2	68.8	15.9	59.0	12.8	49.1	10.1	39.3	7.70	29.5	5.63
-3.0	-3.7	91.9	91.9	26.6	82.7	22.7	73.5	19.0	64.4	15.7	55.2	12.7	46.0	9.97	36.8	7.61	27.6	5.56
-5.0	-5.6	87.9	87.9	26.4	79.1	22.5	70.3	18.9	61.5	15.6	52.7	12.6	44.0	9.89	35.2	7.55	26.4	5.52
-7.0	-7.6	83.7	83.7	26.2	75.3	22.3	66.9	18.7	58.6	15.4	50.2	12.5	41.8	9.81	33.5	7.48	25.1	5.47
-10	-10.5	77.5	77.5	25.9	69.8	22.0	62.0	18.5	54.3	15.2	46.5	12.3	38.8	9.69	31.0	7.39	23.3	5.40
-14.5	-15.0	68.0	68.0	25.4	61.2	21.6	54.4	18.1	47.6	14.9	40.8	12.1	34.0	9.50	27.2	7.25	20.4	5.30

TC : Total Capacity PI : Power Input
 Indoor air temperature conditions : 20.0 °C dry-bulb



MMY-AP3826HT8P (38HP, 107kW system)

Cooling			Compressor + Outdoor Fan Power consumption (kW)															
Outdoor Unit Dry-Bulb (°C)		Outdoor Unit 100% Cooling Capacity (kW)	100%		90%		80%		70%		60%		50%		40%		30%	
			TC (kW)	PI (kW)	TC (kW)	PI (kW)	TC (kW)	PI (kW)	TC (kW)	PI (kW)	TC (kW)	PI (kW)	TC (kW)	PI (kW)	TC (kW)	PI (kW)	TC (kW)	PI (kW)
40		99.6	99.6	32.8	89.6	27.1	79.7	21.9	69.7	17.4	59.7	13.4	49.8	9.97	39.8	7.14	29.9	4.88
39		101.2	101.2	32.3	91.1	26.7	80.9	21.6	70.8	17.1	60.7	13.2	50.6	9.82	40.5	7.03	30.4	4.81
37		104.2	104.2	31.3	93.8	25.8	83.4	20.9	72.9	16.6	62.5	12.8	52.1	9.53	41.7	6.82	31.3	4.66
35		107.0	107.0	30.3	96.3	25.0	85.6	20.3	74.9	16.1	64.2	12.4	53.5	9.23	42.8	6.61	32.1	4.52
33		107.0	107.0	28.1	96.3	23.2	85.6	18.8	74.9	14.9	64.2	11.5	53.5	8.60	42.8	6.18	32.1	4.24
31		107.0	107.0	26.1	96.3	21.6	85.6	17.5	74.9	13.9	64.2	10.7	53.5	8.03	42.8	5.79	32.1	4.00
30		107.0	107.0	25.2	96.3	20.8	85.6	16.9	74.9	13.4	64.2	10.4	53.5	7.77	42.8	5.61	32.1	3.88
29		107.0	107.0	24.3	96.3	20.1	85.6	16.3	74.9	13.0	64.2	10.0	53.5	7.52	42.8	5.43	32.1	3.77
27		107.0	107.0	22.6	96.3	18.7	85.6	15.2	74.9	12.1	64.2	9.39	53.5	7.05	42.8	5.11	32.1	3.55
25		107.0	107.0	21.2	96.3	17.5	85.6	14.2	74.9	11.3	64.2	8.79	53.5	6.61	42.8	4.80	32.1	3.35
23		107.0	107.0	20.2	96.3	16.7	85.6	13.6	74.9	10.8	64.2	8.42	53.5	6.35	42.8	4.62	32.1	3.23
21		107.0	107.0	19.8	96.3	16.4	85.6	13.3	74.9	10.6	64.2	8.27	53.5	6.23	42.8	4.54	32.1	3.19
20		107.0	107.0	19.6	96.3	16.2	85.6	13.2	74.9	10.5	64.2	8.19	53.5	6.18	42.8	4.51	32.1	3.17
19		107.0	107.0	19.4	96.3	16.1	85.6	13.1	74.9	10.5	64.2	8.13	53.5	6.14	42.8	4.48	32.1	3.15
17		107.0	107.0	19.1	96.3	15.8	85.6	12.9	74.9	10.3	64.2	8.01	53.5	6.06	42.8	4.43	32.1	3.14
15		107.0	107.0	18.8	96.3	15.6	85.6	12.7	74.9	10.2	64.2	7.91	53.5	5.98	42.8	4.38	32.1	3.13

TC : Total Capacity PI : Power Input
 Indoor air temperature conditions : 27.0 °C dry-bulb / 19.0 °C wet-bulb

Heating			Compressor + Outdoor Fan Power consumption (kW)															
Outdoor Unit Dry-Bulb (°C) / Wet-Bulb (°C)		Outdoor Unit 100% Cooling Capacity (kW)	100%		90%		80%		70%		60%		50%		40%		30%	
			TC (kW)	PI (kW)	TC (kW)	PI (kW)	TC (kW)	PI (kW)	TC (kW)	PI (kW)	TC (kW)	PI (kW)	TC (kW)	PI (kW)	TC (kW)	PI (kW)	TC (kW)	PI (kW)
15.0	13.7	120.0	120.0	24.7	108.0	21.0	96.0	17.7	84.0	14.6	72.0	12.0	60.0	9.59	48.0	7.55	36.0	5.85
13.0	11.8	120.0	120.0	25.6	108.0	21.8	96.0	18.3	84.0	15.1	72.0	12.3	60.0	9.86	48.0	7.73	36.0	5.95
11.0	9.8	120.0	120.0	26.7	108.0	22.7	96.0	19.0	84.0	15.7	72.0	12.7	60.0	10.2	48.0	7.94	36.0	6.08
9.0	7.9	120.0	120.0	27.9	108.0	23.6	96.0	19.8	84.0	16.3	72.0	13.2	60.0	10.5	48.0	8.15	36.0	6.20
7.0	6.0	120.0	120.0	29.1	108.0	24.6	96.0	20.6	84.0	16.9	72.0	13.7	60.0	10.8	48.0	8.37	36.0	6.34
5.0	4.1	115.9	115.9	28.9	104.3	24.4	92.7	20.4	81.1	16.8	69.5	13.6	57.9	10.7	46.3	8.32	34.8	6.29
3.0	2.2	111.7	111.7	28.7	100.6	24.3	89.4	20.3	78.2	16.7	67.0	13.5	55.9	10.7	44.7	8.26	33.5	6.25
0.0	-0.7	105.4	105.4	28.4	94.9	24.0	84.3	20.1	73.8	16.5	63.3	13.3	52.7	10.6	42.2	8.17	31.6	6.18
-3.0	-3.7	98.9	98.9	28.0	89.0	23.7	79.1	19.8	69.2	16.3	59.3	13.2	49.4	10.4	39.6	8.08	29.7	6.11
-5.0	-5.6	94.8	94.8	27.8	85.3	23.6	75.8	19.7	66.3	16.2	56.9	13.1	47.4	10.4	37.9	8.02	28.4	6.07
-7.0	-7.6	90.4	90.4	27.6	81.4	23.4	72.3	19.5	63.3	16.1	54.2	13.0	45.2	10.3	36.2	7.96	27.1	6.03
-10	-10.5	84.1	84.1	27.3	75.7	23.1	67.3	19.3	58.9	15.9	50.5	12.8	42.1	10.2	33.6	7.87	25.2	5.96
-14.5	-15.0	74.3	74.3	26.9	66.9	22.7	59.5	19.0	52.0	15.6	44.6	12.6	37.2	9.99	29.7	7.74	22.3	5.86

TC : Total Capacity PI : Power Input
 Indoor air temperature conditions : 20.0 °C dry-bulb



MMY-AP4026HT8P (40HP, 113.5kW system)

Cooling			Compressor + Outdoor Fan Power consumption (kW)														
Outdoor Unit Dry-Bulb (°C)	Outdoor Unit 100% Cooling Capacity (kW)	100%		90%		80%		70%		60%		50%		40%		30%	
		TC (kW)	PI (kW)	TC (kW)	PI (kW)	TC (kW)	PI (kW)	TC (kW)	PI (kW)	TC (kW)	PI (kW)	TC (kW)	PI (kW)	TC (kW)	PI (kW)	TC (kW)	PI (kW)
40	105.6	105.6	35.0	95.1	28.9	84.5	23.4	73.9	18.6	63.4	14.3	52.8	10.7	42.2	7.65	31.7	5.25
39	107.3	107.3	34.5	96.6	28.5	85.9	23.1	75.1	18.3	64.4	14.1	53.7	10.5	42.9	7.54	32.2	5.17
37	110.5	110.5	33.5	99.5	27.6	88.4	22.4	77.4	17.7	66.3	13.7	55.3	10.2	44.2	7.31	33.2	5.01
35	113.5	113.5	32.4	102.2	26.8	90.8	21.7	79.5	17.2	68.1	13.2	56.8	9.88	45.4	7.08	34.1	4.85
33	113.5	113.5	30.0	102.2	24.8	90.8	20.1	79.5	16.0	68.1	12.3	56.8	9.21	45.4	6.62	34.1	4.56
31	113.5	113.5	27.9	102.2	23.0	90.8	18.7	79.5	14.9	68.1	11.5	56.8	8.60	45.4	6.21	34.1	4.30
30	113.5	113.5	26.9	102.2	22.2	90.8	18.1	79.5	14.3	68.1	11.1	56.8	8.32	45.4	6.01	34.1	4.17
29	113.5	113.5	25.9	102.2	21.5	90.8	17.4	79.5	13.9	68.1	10.7	56.8	8.05	45.4	5.83	34.1	4.05
27	113.5	113.5	24.2	102.2	20.0	90.8	16.3	79.5	13.0	68.1	10.0	56.8	7.55	45.4	5.48	34.1	3.82
25	113.5	113.5	22.6	102.2	18.7	90.8	15.2	79.5	12.1	68.1	9.41	56.8	7.09	45.4	5.15	34.1	3.61
23	113.5	113.5	21.6	102.2	17.9	90.8	14.6	79.5	11.6	68.1	9.02	56.8	6.80	45.4	4.95	34.1	3.48
21	113.5	113.5	21.1	102.2	17.5	90.8	14.3	79.5	11.4	68.1	8.85	56.8	6.68	45.4	4.87	34.1	3.43
20	113.5	113.5	20.9	102.2	17.4	90.8	14.1	79.5	11.3	68.1	8.77	56.8	6.63	45.4	4.84	34.1	3.41
19	113.5	113.5	20.8	102.2	17.2	90.8	14.0	79.5	11.2	68.1	8.70	56.8	6.58	45.4	4.81	34.1	3.39
17	113.5	113.5	20.4	102.2	16.9	90.8	13.8	79.5	11.0	68.1	8.58	56.8	6.49	45.4	4.75	34.1	3.37
15	113.5	113.5	20.1	102.2	16.7	90.8	13.6	79.5	10.9	68.1	8.47	56.8	6.41	45.4	4.70	34.1	3.35

TC : Total Capacity PI : Power Input
 Indoor air temperature conditions : 27.0 °C dry-bulb / 19.0 °C wet-bulb

Heating			Compressor + Outdoor Fan Power consumption (kW)															
Outdoor Unit		Outdoor Unit 100% Cooling Capacity (kW)	100%		90%		80%		70%		60%		50%		40%		30%	
Dry-Bulb (°C)	Wet-Bulb (°C)		TC (kW)	PI (kW)	TC (kW)	PI (kW)	TC (kW)	PI (kW)	TC (kW)	PI (kW)	TC (kW)	PI (kW)	TC (kW)	PI (kW)	TC (kW)	PI (kW)	TC (kW)	PI (kW)
15.0	13.7	127.5	127.5	25.7	114.8	21.8	102.0	18.3	89.3	15.2	76.5	12.4	63.8	10.0	51.0	8.05	38.3	6.45
13.0	11.8	127.5	127.5	26.7	114.8	22.6	102.0	19.0	89.3	15.7	76.5	12.8	63.8	10.3	51.0	8.22	38.3	6.54
11.0	9.8	127.5	127.5	27.9	114.8	23.6	102.0	19.7	89.3	16.3	76.5	13.2	63.8	10.6	51.0	8.42	38.3	6.65
9.0	7.9	127.5	127.5	29.1	114.8	24.6	102.0	20.5	89.3	16.9	76.5	13.7	63.8	10.9	51.0	8.62	38.3	6.77
7.0	6.0	127.5	127.5	30.4	114.8	25.7	102.0	21.3	89.3	17.5	76.5	14.1	63.8	11.3	51.0	8.83	38.3	6.89
5.0	4.1	123.3	123.3	30.2	110.9	25.5	98.6	21.2	86.3	17.4	74.0	14.1	61.6	11.2	49.3	8.78	37.0	6.85
3.0	2.2	119.0	119.0	30.1	107.1	25.3	95.2	21.1	83.3	17.3	71.4	14.0	59.5	11.1	47.6	8.72	35.7	6.80
0.0	-0.7	112.6	112.6	29.8	101.3	25.1	90.0	20.9	78.8	17.1	67.5	13.8	56.3	11.0	45.0	8.64	33.8	6.74
-3.0	-3.7	105.9	105.9	29.5	95.3	24.8	84.7	20.7	74.1	16.9	63.5	13.7	52.9	10.9	42.3	8.55	31.8	6.67
-5.0	-5.6	101.6	101.6	29.3	91.5	24.7	81.3	20.5	71.1	16.8	61.0	13.6	50.8	10.8	40.7	8.50	30.5	6.63
-7.0	-7.6	97.2	97.2	29.1	87.5	24.5	77.7	20.4	68.0	16.7	58.3	13.5	48.6	10.7	38.9	8.44	29.2	6.58
-10	-10.5	90.7	90.7	28.8	81.6	24.3	72.6	20.2	63.5	16.6	54.4	13.4	45.4	10.6	36.3	8.35	27.2	6.52
-14.5	-15.0	80.7	80.7	28.3	72.6	23.9	64.5	19.9	56.5	16.3	48.4	13.2	40.3	10.5	32.3	8.22	24.2	6.41

TC : Total Capacity PI : Power Input
 Indoor air temperature conditions : 20.0 °C dry-bulb



MMY-AP4226HT8P (42HP, 120kW system)

Cooling			Compressor + Outdoor Fan Power consumption (kW)															
Outdoor Unit		Outdoor Unit 100% Cooling Capacity (kW)	100%		90%		80%		70%		60%		50%		40%		30%	
Dry-Bulb (°C)	TC		PI	TC	PI	TC	PI	TC	PI	TC	PI	TC	PI	TC	PI	TC	PI	
	(kW)		(kW)	(kW)	(kW)	(kW)	(kW)	(kW)	(kW)	(kW)	(kW)	(kW)	(kW)	(kW)	(kW)	(kW)	(kW)	(kW)
40		111.7	111.7	37.3	100.5	30.8	89.3	25.0	78.2	19.8	67.0	15.3	55.8	11.4	44.7	8.17	33.5	5.61
39		113.5	113.5	36.7	102.1	30.3	90.8	24.6	79.4	19.5	68.1	15.0	56.7	11.2	45.4	8.05	34.0	5.53
37		116.9	116.9	35.6	105.2	29.4	93.5	23.8	81.8	18.9	70.1	14.6	58.4	10.9	46.7	7.80	35.1	5.36
35		120.0	120.0	34.5	108.0	28.5	96.0	23.1	84.0	18.3	72.0	14.1	60.0	10.5	48.0	7.56	36.0	5.19
33		120.0	120.0	31.9	108.0	26.4	96.0	21.4	84.0	17.0	72.0	13.1	60.0	9.82	48.0	7.07	36.0	4.88
31		120.0	120.0	29.7	108.0	24.5	96.0	19.9	84.0	15.8	72.0	12.2	60.0	9.17	48.0	6.63	36.0	4.60
30		120.0	120.0	28.6	108.0	23.7	96.0	19.2	84.0	15.3	72.0	11.8	60.0	8.88	48.0	6.42	36.0	4.46
29		120.0	120.0	27.6	108.0	22.9	96.0	18.6	84.0	14.8	72.0	11.4	60.0	8.59	48.0	6.22	36.0	4.33
27		120.0	120.0	25.8	108.0	21.3	96.0	17.3	84.0	13.8	72.0	10.7	60.0	8.05	48.0	5.85	36.0	4.09
25		120.0	120.0	24.1	108.0	19.9	96.0	16.2	84.0	12.9	72.0	10.0	60.0	7.56	48.0	5.50	36.0	3.86
23		120.0	120.0	23.0	108.0	19.1	96.0	15.5	84.0	12.4	72.0	9.61	60.0	7.25	48.0	5.29	36.0	3.72
21		120.0	120.0	22.5	108.0	18.7	96.0	15.2	84.0	12.1	72.0	9.43	60.0	7.12	48.0	5.21	36.0	3.68
20		120.0	120.0	22.3	108.0	18.5	96.0	15.1	84.0	12.0	72.0	9.35	60.0	7.07	48.0	5.17	36.0	3.65
19		120.0	120.0	22.1	108.0	18.3	96.0	14.9	84.0	11.9	72.0	9.27	60.0	7.02	48.0	5.14	36.0	3.63
17		120.0	120.0	21.7	108.0	18.0	96.0	14.7	84.0	11.7	72.0	9.14	60.0	6.92	48.0	5.07	36.0	3.60
15		120.0	120.0	21.4	108.0	17.8	96.0	14.5	84.0	11.6	72.0	9.03	60.0	6.84	48.0	5.02	36.0	3.57

TC : Total Capacity PI : Power Input
 Indoor air temperature conditions : 27.0 °C dry-bulb / 19.0 °C wet-bulb

Heating			Compressor + Outdoor Fan Power consumption (kW)															
Outdoor Unit		Outdoor Unit 100% Cooling Capacity (kW)	100%		90%		80%		70%		60%		50%		40%		30%	
Dry-Bulb (°C)	Wet-Bulb (°C)		TC	PI	TC	PI	TC	PI	TC	PI	TC	PI	TC	PI	TC	PI	TC	PI
			(kW)	(kW)	(kW)	(kW)	(kW)	(kW)	(kW)	(kW)	(kW)	(kW)	(kW)	(kW)	(kW)	(kW)	(kW)	(kW)
15.0	13.7	135.0	135.0	26.7	121.5	22.6	108.0	18.9	94.5	15.7	81.0	12.9	67.5	10.5	54.0	8.55	40.5	7.05
13.0	11.8	135.0	135.0	27.8	121.5	23.5	108.0	19.6	94.5	16.2	81.0	13.2	67.5	10.7	54.0	8.71	40.5	7.13
11.0	9.8	135.0	135.0	29.1	121.5	24.5	108.0	20.4	94.5	16.8	81.0	13.7	67.5	11.0	54.0	8.89	40.5	7.23
9.0	7.9	135.0	135.0	30.4	121.5	25.6	108.0	21.2	94.5	17.4	81.0	14.1	67.5	11.4	54.0	9.09	40.5	7.33
7.0	6.0	135.0	135.0	31.8	121.5	26.7	108.0	22.1	94.5	18.1	81.0	14.6	67.5	11.7	54.0	9.30	40.5	7.44
5.0	4.1	130.7	130.7	31.6	117.6	26.5	104.5	22.0	91.5	18.0	78.4	14.5	65.3	11.6	52.3	9.24	39.2	7.40
3.0	2.2	126.3	126.3	31.4	113.7	26.4	101.0	21.9	88.4	17.9	75.8	14.5	63.2	11.6	50.5	9.19	37.9	7.36
0.0	-0.7	119.7	119.7	31.2	107.7	26.2	95.7	21.7	83.8	17.7	71.8	14.3	59.8	11.5	47.9	9.11	35.9	7.29
-3.0	-3.7	112.8	112.8	30.9	101.5	25.9	90.3	21.5	79.0	17.6	67.7	14.2	56.4	11.4	45.1	9.02	33.8	7.22
-5.0	-5.6	108.5	108.5	30.7	97.6	25.8	86.8	21.4	75.9	17.5	65.1	14.1	54.2	11.3	43.4	8.97	32.5	7.18
-7.0	-7.6	103.9	103.9	30.5	93.5	25.6	83.1	21.2	72.7	17.4	62.4	14.0	52.0	11.2	41.6	8.92	31.2	7.14
-10	-10.5	97.3	97.3	30.2	87.6	25.4	77.8	21.0	68.1	17.2	58.4	13.9	48.6	11.1	38.9	8.84	29.2	7.07
-14.5	-15.0	87.0	87.0	29.8	78.3	25.0	69.6	20.7	60.9	17.0	52.2	13.7	43.5	11.0	34.8	8.71	26.1	6.97

TC : Total Capacity PI : Power Input
 Indoor air temperature conditions : 20.0 °C dry-bulb



MMY-AP4426HT8P (44HP, 125kW system)

Cooling			Compressor + Outdoor Fan Power consumption (kW)															
Outdoor Unit Dry-Bulb (°C)		Outdoor Unit 100% Cooling Capacity (kW)	100%		90%		80%		70%		60%		50%		40%		30%	
			TC (kW)	PI (kW)	TC (kW)	PI (kW)	TC (kW)	PI (kW)	TC (kW)	PI (kW)	TC (kW)	PI (kW)	TC (kW)	PI (kW)	TC (kW)	PI (kW)	TC (kW)	PI (kW)
40		116.3	116.3	39.5	104.7	32.6	93.1	26.4	81.4	20.8	69.8	16.0	58.2	11.9	46.5	8.48	34.9	5.76
39		118.2	118.2	39.0	106.4	32.1	94.6	26.0	82.7	20.5	70.9	15.8	59.1	11.7	47.3	8.35	35.5	5.67
37		121.7	121.7	37.8	109.5	31.2	97.4	25.2	85.2	19.9	73.0	15.3	60.9	11.4	48.7	8.10	36.5	5.50
35		125.0	125.0	36.6	112.5	30.2	100.0	24.4	87.5	19.3	75.0	14.8	62.5	11.0	50.0	7.84	37.5	5.33
33		125.0	125.0	33.9	112.5	28.0	100.0	22.6	87.5	17.9	75.0	13.8	62.5	10.3	50.0	7.33	37.5	5.00
31		125.0	125.0	31.5	112.5	26.0	100.0	21.0	87.5	16.7	75.0	12.8	62.5	9.58	50.0	6.87	37.5	4.71
30		125.0	125.0	30.3	112.5	25.1	100.0	20.3	87.5	16.1	75.0	12.4	62.5	9.26	50.0	6.65	37.5	4.57
29		125.0	125.0	29.3	112.5	24.2	100.0	19.6	87.5	15.5	75.0	12.0	62.5	8.96	50.0	6.44	37.5	4.44
27		125.0	125.0	27.3	112.5	22.6	100.0	18.3	87.5	14.5	75.0	11.2	62.5	8.40	50.0	6.05	37.5	4.18
25		125.0	125.0	25.5	112.5	21.1	100.0	17.1	87.5	13.6	75.0	10.5	62.5	7.88	50.0	5.69	37.5	3.95
23		125.0	125.0	24.4	112.5	20.2	100.0	16.4	87.5	13.0	75.0	10.1	62.5	7.55	50.0	5.47	37.5	3.80
21		125.0	125.0	23.8	112.5	19.7	100.0	16.0	87.5	12.7	75.0	9.87	62.5	7.42	50.0	5.38	37.5	3.75
20		125.0	125.0	23.6	112.5	19.5	100.0	15.9	87.5	12.6	75.0	9.79	62.5	7.36	50.0	5.34	37.5	3.73
19		125.0	125.0	23.4	112.5	19.4	100.0	15.7	87.5	12.5	75.0	9.71	62.5	7.30	50.0	5.30	37.5	3.71
17		125.0	125.0	23.0	112.5	19.1	100.0	15.5	87.5	12.3	75.0	9.57	62.5	7.20	50.0	5.24	37.5	3.67
15		125.0	125.0	22.7	112.5	18.8	100.0	15.3	87.5	12.2	75.0	9.45	62.5	7.12	50.0	5.18	37.5	3.64

TC : Total Capacity PI : Power Input
 Indoor air temperature conditions : 27.0 °C dry-bulb / 19.0 °C wet-bulb

Heating			Compressor + Outdoor Fan Power consumption (kW)															
Outdoor Unit		Outdoor Unit 100% Cooling Capacity (kW)	100%		90%		80%		70%		60%		50%		40%		30%	
Dry-Bulb (°C)	Wet-Bulb (°C)		TC (kW)	PI (kW)	TC (kW)	PI (kW)	TC (kW)	PI (kW)	TC (kW)	PI (kW)	TC (kW)	PI (kW)	TC (kW)	PI (kW)	TC (kW)	PI (kW)	TC (kW)	PI (kW)
15.0	13.7	140.0	140.0	28.3	126.0	23.9	112.0	20.0	98.0	16.5	84.0	13.5	70.0	11.0	56.0	8.94	42.0	7.34
13.0	11.8	140.0	140.0	29.5	126.0	24.9	112.0	20.7	98.0	17.1	84.0	13.9	70.0	11.3	56.0	9.11	42.0	7.43
11.0	9.8	140.0	140.0	30.8	126.0	25.9	112.0	21.6	98.0	17.7	84.0	14.4	70.0	11.6	56.0	9.31	42.0	7.53
9.0	7.9	140.0	140.0	32.2	126.0	27.1	112.0	22.5	98.0	18.4	84.0	14.9	70.0	11.9	56.0	9.51	42.0	7.64
7.0	6.0	140.0	140.0	33.7	126.0	28.3	112.0	23.4	98.0	19.1	84.0	15.4	70.0	12.3	56.0	9.74	42.0	7.76
5.0	4.1	135.3	135.3	33.5	121.8	28.1	108.2	23.3	94.7	19.0	81.2	15.3	67.7	12.2	54.1	9.68	40.6	7.71
3.0	2.2	130.6	130.6	33.3	117.6	27.9	104.5	23.1	91.4	18.9	78.4	15.2	65.3	12.1	52.2	9.61	39.2	7.66
0.0	-0.7	123.5	123.5	32.9	111.1	27.6	98.8	22.9	86.4	18.7	74.1	15.1	61.7	12.0	49.4	9.52	37.0	7.59
-3.0	-3.7	116.1	116.1	32.6	104.5	27.3	92.9	22.6	81.3	18.5	69.6	14.9	58.0	11.9	46.4	9.42	34.8	7.51
-5.0	-5.6	111.4	111.4	32.4	100.3	27.2	89.1	22.5	78.0	18.4	66.8	14.8	55.7	11.8	44.6	9.36	33.4	7.46
-7.0	-7.6	106.5	106.5	32.1	95.8	27.0	85.2	22.3	74.5	18.2	63.9	14.7	53.2	11.7	42.6	9.29	31.9	7.41
-10	-10.5	99.3	99.3	31.8	89.4	26.7	79.5	22.1	69.5	18.1	59.6	14.6	49.7	11.6	39.7	9.20	29.8	7.33
-14.5	-15.0	88.2	88.2	31.3	79.4	26.3	70.6	21.7	61.8	17.8	52.9	14.3	44.1	11.4	35.3	9.05	26.5	7.21

TC : Total Capacity PI : Power Input
 Indoor air temperature conditions : 20.0 °C dry-bulb



MMY-AP5426HT8P (54HP, 152kW system)

Cooling			Compressor + Outdoor Fan Power consumption (kW)															
Outdoor Unit Dry-Bulb (°C)		Outdoor Unit 100% Cooling Capacity (kW)	100%		90%		80%		70%		60%		50%		40%		30%	
			TC (kW)	PI (kW)	TC (kW)	PI (kW)	TC (kW)	PI (kW)	TC (kW)	PI (kW)	TC (kW)	PI (kW)	TC (kW)	PI (kW)	TC (kW)	PI (kW)	TC (kW)	PI (kW)
40		141.4	141.4	50.9	127.3	41.6	113.2	33.3	99.0	26.1	84.9	19.8	70.7	14.6	56.6	10.3	42.4	7.11
39		143.7	143.7	50.1	129.3	41.0	115.0	32.9	100.6	25.7	86.2	19.5	71.9	14.4	57.5	10.2	43.1	7.01
37		148.0	148.0	48.6	133.2	39.8	118.4	31.9	103.6	24.9	88.8	18.9	74.0	13.9	59.2	9.88	44.4	6.79
35		152.0	152.0	47.3	136.8	38.5	121.6	30.9	106.4	24.1	91.2	18.4	76.0	13.5	60.8	9.57	45.6	6.58
33		152.0	152.0	43.5	136.8	35.6	121.6	28.6	106.4	22.4	91.2	17.0	76.0	12.6	60.8	8.95	45.6	6.19
31		152.0	152.0	40.3	136.8	33.0	121.6	26.5	106.4	20.8	91.2	15.9	76.0	11.7	60.8	8.38	45.6	5.84
30		152.0	152.0	38.9	136.8	31.8	121.6	25.6	106.4	20.1	91.2	15.3	76.0	11.3	60.8	8.12	45.6	5.67
29		152.0	152.0	37.5	136.8	30.7	121.6	24.7	106.4	19.4	91.2	14.8	76.0	11.0	60.8	7.87	45.6	5.51
27		152.0	152.0	34.9	136.8	28.6	121.6	23.0	106.4	18.1	91.2	13.8	76.0	10.3	60.8	7.39	45.6	5.21
25		152.0	152.0	32.6	136.8	26.7	121.6	21.5	106.4	16.9	91.2	12.9	76.0	9.63	60.8	6.95	45.6	4.92
23		152.0	152.0	31.1	136.8	25.5	121.6	20.5	106.4	16.1	91.2	12.4	76.0	9.23	60.8	6.68	45.6	4.75
21		152.0	152.0	30.4	136.8	24.9	121.6	20.1	106.4	15.8	91.2	12.1	76.0	9.06	60.8	6.58	45.6	4.69
20		152.0	152.0	30.1	136.8	24.7	121.6	19.9	106.4	15.7	91.2	12.0	76.0	8.99	60.8	6.53	45.6	4.67
19		152.0	152.0	29.8	136.8	24.5	121.6	19.7	106.4	15.5	91.2	11.9	76.0	8.92	60.8	6.49	45.6	4.64
17		152.0	152.0	29.3	136.8	24.0	121.6	19.4	106.4	15.3	91.2	11.8	76.0	8.80	60.8	6.41	45.6	4.60
15		152.0	152.0	28.8	136.8	23.7	121.6	19.1	106.4	15.1	91.2	11.6	76.0	8.69	60.8	6.35	45.6	4.56

TC : Total Capacity PI : Power Input
 Indoor air temperature conditions : 27.0 °C dry-bulb / 19.0 °C wet-bulb

Heating			Compressor + Outdoor Fan Power consumption (kW)															
Outdoor Unit Dry-Bulb (°C) / Wet-Bulb (°C)		Outdoor Unit 100% Cooling Capacity (kW)	100%		90%		80%		70%		60%		50%		40%		30%	
			TC (kW)	PI (kW)	TC (kW)	PI (kW)	TC (kW)	PI (kW)	TC (kW)	PI (kW)	TC (kW)	PI (kW)	TC (kW)	PI (kW)	TC (kW)	PI (kW)	TC (kW)	PI (kW)
15.0	13.7	171.0	171.0	37.1	153.9	31.7	136.8	26.7	119.7	22.2	102.6	18.1	85.5	14.5	68.4	11.3	51.3	8.48
13.0	11.8	171.0	171.0	38.6	153.9	32.9	136.8	27.7	119.7	23.0	102.6	18.7	85.5	14.9	68.4	11.5	51.3	8.66
11.0	9.8	171.0	171.0	40.2	153.9	34.2	136.8	28.8	119.7	23.8	102.6	19.3	85.5	15.4	68.4	11.9	51.3	8.87
9.0	7.9	171.0	171.0	41.8	153.9	35.6	136.8	29.9	119.7	24.7	102.6	20.0	85.5	15.8	68.4	12.2	51.3	9.08
7.0	6.0	171.0	171.0	43.6	153.9	37.1	136.8	31.1	119.7	25.6	102.6	20.7	85.5	16.4	68.4	12.6	51.3	9.30
5.0	4.1	165.0	165.0	43.3	148.5	36.8	132.0	30.8	115.5	25.4	99.0	20.6	82.5	16.3	66.0	12.5	49.5	9.24
3.0	2.2	159.1	159.1	43.0	143.2	36.5	127.3	30.6	111.4	25.3	95.4	20.4	79.5	16.1	63.6	12.4	47.7	9.17
0.0	-0.7	150.0	150.0	42.5	135.0	36.1	120.0	30.3	105.0	25.0	90.0	20.2	75.0	16.0	60.0	12.2	45.0	9.07
-3.0	-3.7	140.6	140.6	42.0	126.5	35.7	112.5	29.9	98.4	24.7	84.3	20.0	70.3	15.8	56.2	12.1	42.2	8.97
-5.0	-5.6	134.6	134.6	41.7	121.2	35.4	107.7	29.7	94.2	24.5	80.8	19.8	67.3	15.7	53.8	12.0	40.4	8.90
-7.0	-7.6	128.3	128.3	41.4	115.5	35.2	102.7	29.5	89.8	24.3	77.0	19.7	64.2	15.5	51.3	11.9	38.5	8.83
-10	-10.5	119.2	119.2	40.9	107.3	34.8	95.4	29.1	83.5	24.0	71.5	19.4	59.6	15.4	47.7	11.8	35.8	8.73
-14.5	-15.0	105.1	105.1	40.2	94.6	34.1	84.1	28.6	73.6	23.6	63.1	19.1	52.6	15.1	42.1	11.6	31.5	8.57

TC : Total Capacity PI : Power Input
 Indoor air temperature conditions : 20.0 °C dry-bulb



MMY-MAP0806HT7P (8HP, 22.4kW system)

Cooling			Compressor + Outdoor Fan Power consumption (kW)															
Outdoor Unit Dry-Bulb (°C)		Outdoor Unit 100% Cooling Capacity (kW)	100%		90%		80%		70%		60%		50%		40%		30%	
			TC (kW)	PI (kW)	TC (kW)	PI (kW)	TC (kW)	PI (kW)	TC (kW)	PI (kW)	TC (kW)	PI (kW)	TC (kW)	PI (kW)	TC (kW)	PI (kW)	TC (kW)	PI (kW)
40		20.8	20.8	5.61	18.8	4.65	16.7	3.81	14.6	3.06	12.5	2.43	10.4	1.89	8.34	1.47	6.25	1.14
39		21.2	21.2	5.52	19.1	4.58	17.0	3.75	14.8	3.02	12.7	2.39	10.6	1.87	8.48	1.44	6.36	1.13
37		21.8	21.8	5.36	19.6	4.45	17.4	3.64	15.3	2.93	13.1	2.32	10.9	1.81	8.72	1.40	6.54	1.09
35		22.4	22.4	5.19	20.2	4.31	17.9	3.52	15.7	2.84	13.4	2.25	11.2	1.75	8.96	1.36	6.72	1.06
33		22.4	22.4	4.81	20.2	4.00	17.9	3.27	15.7	2.64	13.4	2.10	11.2	1.64	8.96	1.28	6.72	1.01
31		22.4	22.4	4.47	20.2	3.72	17.9	3.05	15.7	2.47	13.4	1.97	11.2	1.55	8.96	1.21	6.72	0.96
30		22.4	22.4	4.31	20.2	3.59	17.9	2.95	15.7	2.39	13.4	1.90	11.2	1.50	8.96	1.18	6.72	0.93
29		22.4	22.4	4.17	20.2	3.47	17.9	2.85	15.7	2.31	13.4	1.84	11.2	1.46	8.96	1.15	6.72	0.91
27		22.4	22.4	3.89	20.2	3.24	17.9	2.67	15.7	2.17	13.4	1.73	11.2	1.37	8.96	1.08	6.72	0.87
25		22.4	22.4	3.64	20.2	3.04	17.9	2.50	15.7	2.03	13.4	1.63	11.2	1.29	8.96	1.03	6.72	0.82
23		22.4	22.4	3.48	20.2	2.91	17.9	2.40	15.7	1.95	13.4	1.57	11.2	1.25	8.96	0.99	6.72	0.80
21		22.4	22.4	3.41	20.2	2.85	17.9	2.35	15.7	1.92	13.4	1.54	11.2	1.23	8.96	0.98	6.72	0.79
20		22.4	22.4	3.38	20.2	2.82	17.9	2.33	15.7	1.90	13.4	1.53	11.2	1.22	8.96	0.98	6.72	0.79
19		22.4	22.4	3.35	20.2	2.80	17.9	2.31	15.7	1.89	13.4	1.52	11.2	1.22	8.96	0.97	6.72	0.79
17		22.4	22.4	3.29	20.2	2.76	17.9	2.28	15.7	1.86	13.4	1.50	11.2	1.20	8.96	0.97	6.72	0.79
15		22.4	22.4	3.25	20.2	2.72	17.9	2.25	15.7	1.84	13.4	1.49	11.2	1.19	8.96	0.96	6.72	0.78

TC : Total Capacity PI : Power Input
 Indoor air temperature conditions : 27.0 °C dry-bulb / 19.0 °C wet-bulb

Heating			Compressor + Outdoor Fan Power consumption (kW)															
Outdoor Unit Dry-Bulb (°C) / Wet-Bulb (°C)		Outdoor Unit 100% Cooling Capacity (kW)	100%		90%		80%		70%		60%		50%		40%		30%	
			TC (kW)	PI (kW)	TC (kW)	PI (kW)	TC (kW)	PI (kW)	TC (kW)	PI (kW)	TC (kW)	PI (kW)	TC (kW)	PI (kW)	TC (kW)	PI (kW)	TC (kW)	PI (kW)
15.0	13.7	25.0	25.0	4.51	22.5	3.81	20.0	3.17	17.5	2.62	15.0	2.14	12.5	1.73	10.0	1.40	7.5	1.15
13.0	11.8	25.0	25.0	4.70	22.5	3.96	20.0	3.29	17.5	2.71	15.0	2.20	12.5	1.78	10.0	1.43	7.5	1.16
11.0	9.8	25.0	25.0	4.92	22.5	4.13	20.0	3.43	17.5	2.81	15.0	2.28	12.5	1.83	10.0	1.46	7.5	1.18
9.0	7.9	25.0	25.0	5.14	22.5	4.31	20.0	3.57	17.5	2.92	15.0	2.36	12.5	1.88	10.0	1.49	7.5	1.20
7.0	6.0	25.0	25.0	5.38	22.5	4.51	20.0	3.72	17.5	3.04	15.0	2.44	12.5	1.94	10.0	1.53	7.5	1.21
5.0	4.1	24.3	24.3	5.36	21.8	4.49	19.4	3.71	17.0	3.03	14.6	2.43	12.1	1.93	9.7	1.53	7.3	1.21
3.0	2.2	23.5	23.5	5.35	21.2	4.48	18.8	3.70	16.5	3.02	14.1	2.43	11.8	1.93	9.4	1.52	7.1	1.21
0.0	-0.7	22.4	22.4	5.32	20.2	4.46	17.9	3.68	15.7	3.00	13.5	2.42	11.2	1.92	9.0	1.51	6.7	1.20
-3.0	-3.7	21.3	21.3	5.30	19.1	4.44	17.0	3.67	14.9	2.99	12.8	2.40	10.6	1.91	8.5	1.51	6.4	1.20
-5.0	-5.6	20.5	20.5	5.28	18.5	4.42	16.4	3.66	14.4	2.98	12.3	2.40	10.3	1.90	8.2	1.50	6.2	1.19
-7.0	-7.6	19.8	19.8	5.26	17.8	4.41	15.8	3.64	13.8	2.97	11.9	2.39	9.9	1.90	7.9	1.50	5.9	1.19
-10	-10.5	18.7	18.7	5.24	16.8	4.39	14.9	3.63	13.1	2.96	11.2	2.38	9.3	1.89	7.5	1.49	5.6	1.18
-14.5	-15.0	16.9	16.9	5.20	15.2	4.35	13.5	3.60	11.8	2.93	10.2	2.36	8.5	1.87	6.8	1.48	5.1	1.17

TC : Total Capacity PI : Power Input
 Indoor air temperature conditions : 20.0 °C dry-bulb



MMY-MAP1006HT7P (10HP, 28kW system)

Cooling			Compressor + Outdoor Fan Power consumption (kW)															
Outdoor Unit Dry-Bulb (°C)		Outdoor Unit 100% Cooling Capacity (kW)	100%		90%		80%		70%		60%		50%		40%		30%	
			TC (kW)	PI (kW)	TC (kW)	PI (kW)	TC (kW)	PI (kW)	TC (kW)	PI (kW)	TC (kW)	PI (kW)	TC (kW)	PI (kW)	TC (kW)	PI (kW)	TC (kW)	PI (kW)
40		26.1	26.1	7.84	23.5	6.44	20.8	5.19	18.2	4.11	15.6	3.19	13.0	2.43	10.42	1.84	7.82	1.40
39		26.5	26.5	7.73	23.8	6.34	21.2	5.12	18.5	4.05	15.9	3.14	13.2	2.40	10.59	1.81	7.94	1.38
37		27.3	27.3	7.49	24.5	6.15	21.8	4.96	19.1	3.93	16.4	3.05	13.6	2.32	10.91	1.75	8.18	1.34
35		28.0	28.0	7.26	25.2	5.96	22.4	4.81	19.6	3.80	16.8	2.95	14.0	2.25	11.20	1.70	8.40	1.30
33		28.0	28.0	6.71	25.2	5.51	22.4	4.45	19.6	3.53	16.8	2.75	14.0	2.11	11.20	1.60	8.40	1.23
31		28.0	28.0	6.22	25.2	5.12	22.4	4.14	19.6	3.29	16.8	2.57	14.0	1.98	11.20	1.51	8.40	1.17
30		28.0	28.0	6.00	25.2	4.94	22.4	4.00	19.6	3.18	16.8	2.49	14.0	1.92	11.20	1.47	8.40	1.14
29		28.0	28.0	5.79	25.2	4.76	22.4	3.86	19.6	3.07	16.8	2.41	14.0	1.86	11.20	1.43	8.40	1.11
27		28.0	28.0	5.39	25.2	4.44	22.4	3.60	19.6	2.88	16.8	2.26	14.0	1.75	11.20	1.35	8.40	1.06
25		28.0	28.0	5.03	25.2	4.15	22.4	3.37	19.6	2.69	16.8	2.12	14.0	1.64	11.20	1.28	8.40	1.01
23		28.0	28.0	4.81	25.2	3.97	22.4	3.22	19.6	2.58	16.8	2.03	14.0	1.58	11.20	1.23	8.40	0.98
21		28.0	28.0	4.70	25.2	3.88	22.4	3.16	19.6	2.53	16.8	2.00	14.0	1.56	11.20	1.22	8.40	0.97
20		28.0	28.0	4.66	25.2	3.85	22.4	3.13	19.6	2.51	16.8	1.98	14.0	1.55	11.20	1.21	8.40	0.97
19		28.0	28.0	4.61	25.2	3.81	22.4	3.10	19.6	2.49	16.8	1.97	14.0	1.54	11.20	1.21	8.40	0.96
17		28.0	28.0	4.54	25.2	3.75	22.4	3.06	19.6	2.45	16.8	1.94	14.0	1.52	11.20	1.19	8.40	0.96
15		28.0	28.0	4.47	25.2	3.70	22.4	3.01	19.6	2.42	16.8	1.92	14.0	1.51	11.20	1.19	8.40	0.96

TC : Total Capacity PI : Power Input
 Indoor air temperature conditions : 27.0 °C dry-bulb / 19.0 °C wet-bulb

Heating			Compressor + Outdoor Fan Power consumption (kW)															
Outdoor Unit Dry-Bulb (°C) / Wet-Bulb (°C)		Outdoor Unit 100% Cooling Capacity (kW)	100%		90%		80%		70%		60%		50%		40%		30%	
			TC (kW)	PI (kW)	TC (kW)	PI (kW)	TC (kW)	PI (kW)	TC (kW)	PI (kW)	TC (kW)	PI (kW)	TC (kW)	PI (kW)	TC (kW)	PI (kW)	TC (kW)	PI (kW)
15.0	13.7	31.5	31.5	6.00	28.4	5.10	25.2	4.28	22.1	3.55	18.9	2.91	15.8	2.34	12.6	1.86	9.5	1.46
13.0	11.8	31.5	31.5	6.23	28.4	5.29	25.2	4.44	22.1	3.67	18.9	3.00	15.8	2.41	12.6	1.90	9.5	1.49
11.0	9.8	31.5	31.5	6.50	28.4	5.51	25.2	4.62	22.1	3.81	18.9	3.10	15.8	2.48	12.6	1.95	9.5	1.51
9.0	7.9	31.5	31.5	6.78	28.4	5.74	25.2	4.80	22.1	3.95	18.9	3.20	15.8	2.55	12.6	2.00	9.5	1.54
7.0	6.0	31.5	31.5	7.08	28.4	5.98	25.2	4.99	22.1	4.10	18.9	3.32	15.8	2.63	12.6	2.05	9.5	1.57
5.0	4.1	30.5	30.5	7.04	27.4	5.95	24.4	4.96	21.3	4.08	18.3	3.30	15.2	2.62	12.2	2.04	9.1	1.57
3.0	2.2	29.5	29.5	7.00	26.5	5.92	23.6	4.94	20.6	4.06	17.7	3.28	14.7	2.60	11.8	2.03	8.8	1.56
0.0	-0.7	27.9	27.9	6.94	25.1	5.86	22.3	4.89	19.5	4.02	16.8	3.25	14.0	2.58	11.2	2.01	8.4	1.54
-3.0	-3.7	26.3	26.3	6.87	23.7	5.81	21.1	4.85	18.4	3.98	15.8	3.22	13.2	2.56	10.5	1.99	7.9	1.53
-5.0	-5.6	25.3	25.3	6.83	22.8	5.78	20.3	4.82	17.7	3.96	15.2	3.20	12.7	2.54	10.1	1.98	7.6	1.52
-7.0	-7.6	24.2	24.2	6.79	21.8	5.74	19.4	4.79	17.0	3.94	14.5	3.18	12.1	2.53	9.7	1.97	7.3	1.51
-10	-10.5	22.7	22.7	6.73	20.4	5.69	18.2	4.74	15.9	3.90	13.6	3.15	11.4	2.50	9.1	1.95	6.8	1.50
-14.5	-15.0	20.3	20.3	6.63	18.3	5.61	16.2	4.68	14.2	3.84	12.2	3.11	10.2	2.47	8.1	1.92	6.1	1.48

TC : Total Capacity PI : Power Input
 Indoor air temperature conditions : 20.0 °C dry-bulb



MMY-MAP1206HT7P (12HP, 33.5kW system)

Cooling			Compressor + Outdoor Fan Power consumption (kW)															
Outdoor Unit Dry-Bulb (°C)		Outdoor Unit 100% Cooling Capacity (kW)	100%		90%		80%		70%		60%		50%		40%		30%	
			TC	PI	TC	PI	TC	PI	TC	PI	TC	PI	TC	PI	TC	PI	TC	PI
			(kW)	(kW)	(kW)	(kW)	(kW)	(kW)	(kW)	(kW)	(kW)	(kW)	(kW)	(kW)	(kW)	(kW)	(kW)	(kW)
40		31.2	31.2	10.2	28.1	8.39	24.9	6.80	21.8	5.39	18.7	4.15	15.6	3.09	12.5	2.21	9.35	1.51
39		31.7	31.7	10.0	28.5	8.27	25.3	6.70	22.2	5.31	19.0	4.09	15.8	3.04	12.67	2.18	9.50	1.48
37		32.6	32.6	9.71	29.4	8.02	26.1	6.50	22.8	5.14	19.6	3.96	16.3	2.95	13.05	2.11	9.79	1.44
35		33.5	33.5	9.41	30.2	7.77	26.8	6.29	23.5	4.98	20.1	3.84	16.8	2.86	13.40	2.04	10.05	1.39
33		33.5	33.5	8.71	30.2	7.20	26.8	5.84	23.5	4.63	20.1	3.57	16.8	2.66	13.40	1.91	10.05	1.31
31		33.5	33.5	8.09	30.2	6.69	26.8	5.43	23.5	4.31	20.1	3.33	16.8	2.49	13.40	1.79	10.05	1.23
30		33.5	33.5	7.81	30.2	6.45	26.8	5.24	23.5	4.16	20.1	3.22	16.8	2.41	13.40	1.73	10.05	1.20
29		33.5	33.5	7.53	30.2	6.23	26.8	5.06	23.5	4.02	20.1	3.11	16.8	2.33	13.40	1.68	10.05	1.16
27		33.5	33.5	7.03	30.2	5.82	26.8	4.72	23.5	3.76	20.1	2.91	16.8	2.18	13.40	1.58	10.05	1.09
25		33.5	33.5	6.56	30.2	5.43	26.8	4.42	23.5	3.51	20.1	2.72	16.8	2.05	13.40	1.48	10.05	1.03
23		33.5	33.5	6.27	30.2	5.19	26.8	4.23	23.5	3.36	20.1	2.61	16.8	1.96	13.40	1.43	10.05	1.00
21		33.5	33.5	6.14	30.2	5.09	26.8	4.14	23.5	3.30	20.1	2.56	16.8	1.93	13.40	1.40	10.05	0.98
20		33.5	33.5	6.08	30.2	5.04	26.8	4.10	23.5	3.27	20.1	2.54	16.8	1.91	13.40	1.39	10.05	0.98
19		33.5	33.5	6.02	30.2	4.99	26.8	4.07	23.5	3.24	20.1	2.52	16.8	1.90	13.40	1.38	10.05	0.97
17		33.5	33.5	5.93	30.2	4.91	26.8	4.00	23.5	3.19	20.1	2.48	16.8	1.87	13.40	1.37	10.05	0.97
15		33.5	33.5	5.84	30.2	4.85	26.8	3.95	23.5	3.15	20.1	2.45	16.8	1.85	13.40	1.35	10.05	0.97

TC : Total Capacity PI : Power Input
Indoor air temperature conditions : 27.0 °C dry-bulb / 19.0 °C wet-bulb

Heating			Compressor + Outdoor Fan Power consumption (kW)															
Outdoor Unit Dry-Bulb (°C) / Wet-Bulb (°C)		Outdoor Unit 100% Cooling Capacity (kW)	100%		90%		80%		70%		60%		50%		40%		30%	
			TC	PI	TC	PI	TC	PI	TC	PI	TC	PI	TC	PI	TC	PI	TC	PI
			(kW)	(kW)	(kW)	(kW)	(kW)	(kW)	(kW)	(kW)	(kW)	(kW)	(kW)	(kW)	(kW)	(kW)	(kW)	(kW)
15.0	13.7	37.5	37.5	7.88	33.8	6.73	30.0	5.67	26.3	4.71	22.5	3.83	18.8	3.05	15.0	2.35	11.3	1.75
13.0	11.8	37.5	37.5	8.18	33.8	6.98	30.0	5.88	26.3	4.87	22.5	3.96	18.8	3.14	15.0	2.41	11.3	1.79
11.0	9.8	37.5	37.5	8.51	33.8	7.26	30.0	6.10	26.3	5.05	22.5	4.09	18.8	3.24	15.0	2.49	11.3	1.83
9.0	7.9	37.5	37.5	8.86	33.8	7.55	30.0	6.34	26.3	5.23	22.5	4.24	18.8	3.35	15.0	2.56	11.3	1.88
7.0	6.0	37.5	37.5	9.24	33.8	7.86	30.0	6.59	26.3	5.44	22.5	4.39	18.8	3.46	15.0	2.64	11.3	1.93
5.0	4.1	36.2	36.2	9.17	32.5	7.80	28.9	6.54	25.3	5.39	21.7	4.36	18.1	3.43	14.5	2.62	10.8	1.91
3.0	2.2	34.8	34.8	9.10	31.3	7.74	27.9	6.49	24.4	5.35	20.9	4.32	17.4	3.41	13.9	2.60	10.4	1.90
0.0	-0.7	32.8	32.8	8.99	29.5	7.65	26.2	6.41	22.9	5.29	19.7	4.27	16.4	3.37	13.1	2.57	9.8	1.88
-3.0	-3.7	30.6	30.6	8.88	27.6	7.55	24.5	6.34	21.5	5.22	18.4	4.22	15.3	3.32	12.3	2.54	9.2	1.85
-5.0	-5.6	29.3	29.3	8.81	26.4	7.49	23.4	6.29	20.5	5.18	17.6	4.19	14.7	3.30	11.7	2.52	8.8	1.84
-7.0	-7.6	27.9	27.9	8.74	25.1	7.43	22.3	6.23	19.5	5.14	16.7	4.15	13.9	3.27	11.2	2.49	8.4	1.82
-10	-10.5	25.8	25.8	8.63	23.3	7.34	20.7	6.16	18.1	5.08	15.5	4.10	12.9	3.23	10.3	2.46	7.8	1.80
-14.5	-15.0	22.7	22.7	8.46	20.4	7.20	18.1	6.04	15.9	4.98	13.6	4.02	11.3	3.17	9.1	2.42	6.8	1.77

TC : Total Capacity PI : Power Input
Indoor air temperature conditions : 20.0 °C dry-bulb



MMY-MAP1406HT7P (14HP, 40kW system)

Cooling			Compressor + Outdoor Fan Power consumption (kW)														
Outdoor Unit Dry-Bulb (°C)	Outdoor Unit 100% Cooling Capacity (kW)	100%		90%		80%		70%		60%		50%		40%		30%	
		TC	PI	TC	PI	TC	PI	TC	PI	TC	PI	TC	PI	TC	PI	TC	PI
		(kW)	(kW)	(kW)	(kW)	(kW)	(kW)	(kW)	(kW)	(kW)	(kW)	(kW)	(kW)	(kW)	(kW)	(kW)	(kW)
40	37.2	37.2	12.4	33.5	10.3	29.8	8.32	26.1	6.59	22.3	5.08	18.6	3.79	14.9	2.72	11.2	1.87
39	37.8	37.8	12.2	34.0	10.1	30.3	8.19	26.5	6.49	22.7	5.01	18.9	3.74	15.1	2.68	11.3	1.84
37	39.0	39.0	11.9	35.1	9.80	31.2	7.95	27.3	6.30	23.4	4.86	19.5	3.62	15.6	2.60	11.7	1.79
35	40.0	40.0	11.5	36.0	9.50	32.0	7.70	28.0	6.10	24.0	4.70	20.0	3.51	16.0	2.52	12.0	1.73
33	40.0	40.0	10.6	36.0	8.80	32.0	7.14	28.0	5.66	24.0	4.38	20.0	3.27	16.0	2.36	12.0	1.63
31	40.0	40.0	9.89	36.0	8.18	32.0	6.64	28.0	5.27	24.0	4.08	20.0	3.06	16.0	2.21	12.0	1.53
30	40.0	40.0	9.54	36.0	7.89	32.0	6.41	28.0	5.09	24.0	3.94	20.0	2.96	16.0	2.14	12.0	1.49
29	40.0	40.0	9.21	36.0	7.62	32.0	6.19	28.0	4.92	24.0	3.81	20.0	2.86	16.0	2.07	12.0	1.44
27	40.0	40.0	8.59	36.0	7.11	32.0	5.78	28.0	4.60	24.0	3.57	20.0	2.68	16.0	1.95	12.0	1.36
25	40.0	40.0	8.02	36.0	6.65	32.0	5.41	28.0	4.31	24.0	3.34	20.0	2.52	16.0	1.83	12.0	1.29
23	40.0	40.0	7.67	36.0	6.35	32.0	5.17	28.0	4.12	24.0	3.20	20.0	2.42	16.0	1.76	12.0	1.24
21	40.0	40.0	7.51	36.0	6.22	32.0	5.07	28.0	4.04	24.0	3.14	20.0	2.37	16.0	1.74	12.0	1.23
20	40.0	40.0	7.43	36.0	6.16	32.0	5.02	28.0	4.00	24.0	3.12	20.0	2.36	16.0	1.72	12.0	1.22
19	40.0	40.0	7.37	36.0	6.11	32.0	4.98	28.0	3.97	24.0	3.09	20.0	2.34	16.0	1.71	12.0	1.21
17	40.0	40.0	7.25	36.0	6.01	32.0	4.90	28.0	3.91	24.0	3.05	20.0	2.31	16.0	1.69	12.0	1.20
15	40.0	40.0	7.14	36.0	5.93	32.0	4.83	28.0	3.86	24.0	3.01	20.0	2.28	16.0	1.67	12.0	1.19

TC : Total Capacity PI : Power Input
 Indoor air temperature conditions : 27.0 °C dry-bulb / 19.0 °C wet-bulb

Heating			Compressor + Outdoor Fan Power consumption (kW)															
Outdoor Unit		Outdoor Unit 100% Cooling Capacity (kW)	100%		90%		80%		70%		60%		50%		40%		30%	
Dry-Bulb (°C)	Wet-Bulb (°C)		TC	PI	TC	PI	TC	PI	TC	PI	TC	PI	TC	PI	TC	PI	TC	PI
(°C)	(°C)		(kW)	(kW)	(kW)	(kW)	(kW)	(kW)	(kW)	(kW)	(kW)	(kW)	(kW)	(kW)	(kW)	(kW)	(kW)	(kW)
15.0	13.7	45.0	45.0	8.91	40.5	7.54	36.0	6.31	31.5	5.22	27.0	4.29	22.5	3.49	18.0	2.85	13.5	2.35
13.0	11.8	45.0	45.0	9.28	40.5	7.83	36.0	6.54	31.5	5.40	27.0	4.41	22.5	3.58	18.0	2.90	13.5	2.38
11.0	9.8	45.0	45.0	9.70	40.5	8.17	36.0	6.80	31.5	5.60	27.0	4.56	22.5	3.68	18.0	2.96	13.5	2.41
9.0	7.9	45.0	45.0	10.1	40.5	8.52	36.0	7.08	31.5	5.81	27.0	4.71	22.5	3.78	18.0	3.03	13.5	2.44
7.0	6.0	45.0	45.0	10.6	40.5	8.90	36.0	7.38	31.5	6.04	27.0	4.88	22.5	3.90	18.0	3.10	13.5	2.48
5.0	4.1	43.6	43.6	10.5	39.2	8.85	34.8	7.33	30.5	6.00	26.1	4.85	21.8	3.87	17.4	3.08	13.1	2.47
3.0	2.2	42.1	42.1	10.5	37.9	8.80	33.7	7.29	29.5	5.97	25.3	4.82	21.1	3.85	16.8	3.06	12.6	2.45
0.0	-0.7	39.9	39.9	10.4	35.9	8.72	31.9	7.23	27.9	5.91	23.9	4.78	19.9	3.82	16.0	3.04	12.0	2.43
-3.0	-3.7	37.6	37.6	10.3	33.8	8.64	30.1	7.16	26.3	5.86	22.6	4.73	18.8	3.78	15.0	3.01	11.3	2.41
-5.0	-5.6	36.2	36.2	10.2	32.5	8.59	28.9	7.12	25.3	5.83	21.7	4.71	18.1	3.76	14.5	2.99	10.8	2.39
-7.0	-7.6	34.6	34.6	10.2	31.2	8.53	27.7	7.08	24.2	5.79	20.8	4.68	17.3	3.74	13.9	2.97	10.4	2.38
-10	-10.5	32.4	32.4	10.1	29.2	8.46	25.9	7.01	22.7	5.74	19.5	4.63	16.2	3.70	13.0	2.95	9.7	2.36
-14.5	-15.0	29.0	29.0	9.93	26.1	8.34	23.2	6.91	20.3	5.66	17.4	4.57	14.5	3.65	11.6	2.90	8.7	2.32

TC : Total Capacity PI : Power Input
 Indoor air temperature conditions : 20.0 °C dry-bulb



MMY-MAP1606HT7P (16HP, 45kW system)

Cooling			Compressor + Outdoor Fan Power consumption (kW)															
Outdoor Unit		Outdoor Unit 100% Cooling Capacity (kW)	100%		90%		80%		70%		60%		50%		40%		30%	
Dry-Bulb (°C)	TC		PI	TC	PI	TC	PI	TC	PI	TC	PI	TC	PI	TC	PI	TC	PI	
	(kW)		(kW)	(kW)	(kW)	(kW)	(kW)	(kW)	(kW)	(kW)	(kW)	(kW)	(kW)	(kW)	(kW)	(kW)	(kW)	(kW)
40		41.9	41.9	14.7	37.7	12.1	33.5	9.74	29.3	7.67	25.1	5.86	20.9	4.31	16.8	3.03	12.6	2.02
39		42.5	42.5	14.5	38.3	11.9	34.0	9.60	29.8	7.55	25.5	5.77	21.3	4.25	17.0	2.99	12.8	1.99
37		43.8	43.8	14.0	39.4	11.5	35.1	9.31	30.7	7.32	26.3	5.59	21.9	4.12	17.5	2.90	13.1	1.93
35		45.0	45.0	13.6	40.5	11.2	36.0	9.02	31.5	7.09	27.0	5.42	22.5	3.99	18.0	2.80	13.5	1.87
33		45.0	45.0	12.6	40.5	10.4	36.0	8.35	31.5	6.58	27.0	5.03	22.5	3.71	18.0	2.62	13.5	1.75
31		45.0	45.0	11.7	40.5	9.61	36.0	7.76	31.5	6.12	27.0	4.68	22.5	3.46	18.0	2.45	13.5	1.64
30		45.0	45.0	11.3	40.5	9.27	36.0	7.49	31.5	5.90	27.0	4.52	22.5	3.35	18.0	2.37	13.5	1.59
29		45.0	45.0	10.9	40.5	8.95	36.0	7.23	31.5	5.70	27.0	4.37	22.5	3.24	18.0	2.29	13.5	1.55
27		45.0	45.0	10.1	40.5	8.34	36.0	6.74	31.5	5.32	27.0	4.09	22.5	3.03	18.0	2.15	13.5	1.46
25		45.0	45.0	9.45	40.5	7.79	36.0	6.30	31.5	4.98	27.0	3.82	22.5	2.84	18.0	2.02	13.5	1.37
23		45.0	45.0	9.03	40.5	7.44	36.0	6.02	31.5	4.76	27.0	3.66	22.5	2.72	18.0	1.94	13.5	1.32
21		45.0	45.0	8.83	40.5	7.29	36.0	5.90	31.5	4.66	27.0	3.59	22.5	2.67	18.0	1.91	13.5	1.30
20		45.0	45.0	8.74	40.5	7.22	36.0	5.84	31.5	4.62	27.0	3.56	22.5	2.65	18.0	1.89	13.5	1.29
19		45.0	45.0	8.66	40.5	7.15	36.0	5.79	31.5	4.58	27.0	3.53	22.5	2.63	18.0	1.88	13.5	1.29
17		45.0	45.0	8.52	40.5	7.03	36.0	5.70	31.5	4.51	27.0	3.47	22.5	2.59	18.0	1.85	13.5	1.27
15		45.0	45.0	8.40	40.5	6.93	36.0	5.62	31.5	4.45	27.0	3.43	22.5	2.56	18.0	1.83	13.5	1.26

TC : Total Capacity PI : Power Input
 Indoor air temperature conditions : 27.0 °C dry-bulb / 19.0 °C wet-bulb

Heating			Compressor + Outdoor Fan Power consumption (kW)															
Outdoor Unit		Outdoor Unit 100% Cooling Capacity (kW)	100%		90%		80%		70%		60%		50%		40%		30%	
Dry-Bulb (°C)	Wet-Bulb (°C)		TC	PI	TC	PI	TC	PI	TC	PI	TC	PI	TC	PI	TC	PI	TC	PI
			(kW)	(kW)	(kW)	(kW)	(kW)	(kW)	(kW)	(kW)	(kW)	(kW)	(kW)	(kW)	(kW)	(kW)	(kW)	(kW)
15.0	13.7	50.0	50.0	10.5	45.0	8.84	40.0	7.37	35.0	6.08	30.0	4.96	25.0	4.01	20.0	3.24	15.0	2.64
13.0	11.8	50.0	50.0	10.9	45.0	9.19	40.0	7.65	35.0	6.29	30.0	5.11	25.0	4.12	20.0	3.30	15.0	2.67
11.0	9.8	50.0	50.0	11.4	45.0	9.60	40.0	7.97	35.0	6.53	30.0	5.29	25.0	4.24	20.0	3.38	15.0	2.71
9.0	7.9	50.0	50.0	11.9	45.0	10.0	40.0	8.30	35.0	6.78	30.0	5.47	25.0	4.36	20.0	3.46	15.0	2.75
7.0	6.0	50.0	50.0	12.5	45.0	10.5	40.0	8.65	35.0	7.05	30.0	5.67	25.0	4.50	20.0	3.54	15.0	2.80
5.0	4.1	48.2	48.2	12.4	43.4	10.4	38.6	8.59	33.7	7.00	28.9	5.62	24.1	4.46	19.3	3.51	14.5	2.78
3.0	2.2	46.4	46.4	12.3	41.8	10.3	37.1	8.52	32.5	6.95	27.9	5.58	23.2	4.43	18.6	3.49	13.9	2.76
0.0	-0.7	43.7	43.7	12.2	39.3	10.2	34.9	8.42	30.6	6.86	26.2	5.52	21.8	4.38	17.5	3.45	13.1	2.72
-3.0	-3.7	40.9	40.9	12.0	36.8	10.1	32.7	8.32	28.6	6.78	24.5	5.45	20.4	4.32	16.3	3.40	12.3	2.69
-5.0	-5.6	39.1	39.1	11.9	35.2	10.0	31.3	8.25	27.3	6.73	23.4	5.40	19.5	4.29	15.6	3.38	11.7	2.67
-7.0	-7.6	37.2	37.2	11.8	33.5	9.90	29.7	8.18	26.0	6.67	22.3	5.36	18.6	4.25	14.9	3.35	11.2	2.65
-10	-10.5	34.5	34.5	11.7	31.0	9.78	27.6	8.08	24.1	6.59	20.7	5.29	17.2	4.20	13.8	3.31	10.3	2.61
-14.5	-15.0	30.2	30.2	11.4	27.2	9.59	24.2	7.93	21.1	6.46	18.1	5.19	15.1	4.12	12.1	3.24	9.1	2.56

TC : Total Capacity PI : Power Input
 Indoor air temperature conditions : 20.0 °C dry-bulb



MMY-MAP1816HT7P (18HP, 50.4kW system)

Cooling			Compressor + Outdoor Fan Power consumption (kW)															
Outdoor Unit Dry-Bulb (°C)		Outdoor Unit 100% Cooling Capacity (kW)	100%		90%		80%		70%		60%		50%		40%		30%	
			TC (kW)	PI (kW)	TC (kW)	PI (kW)	TC (kW)	PI (kW)	TC (kW)	PI (kW)	TC (kW)	PI (kW)	TC (kW)	PI (kW)	TC (kW)	PI (kW)	TC (kW)	PI (kW)
40		46.9	46.9	15.1	42.2	12.6	37.5	10.4	32.8	8.33	28.1	6.53	23.5	4.95	18.8	3.60	14.1	2.48
39		47.7	47.7	14.9	42.9	12.4	38.1	10.2	33.4	8.21	28.6	6.43	23.8	4.88	19.1	3.55	14.3	2.44
37		49.1	49.1	14.4	44.2	12.1	39.3	9.91	34.4	7.96	29.4	6.24	24.5	4.73	19.6	3.44	14.7	2.37
35		50.4	50.4	14.0	45.4	11.7	40.3	9.60	35.3	7.71	30.2	6.04	25.2	4.58	20.2	3.33	15.1	2.29
33		50.4	50.4	13.0	45.4	10.9	40.3	8.92	35.3	7.18	30.2	5.63	25.2	4.28	20.2	3.12	15.1	2.15
31		50.4	50.4	12.1	45.4	10.1	40.3	8.32	35.3	6.70	30.2	5.26	25.2	4.00	20.2	2.92	15.1	2.03
30		50.4	50.4	11.7	45.4	9.77	40.3	8.04	35.3	6.48	30.2	5.09	25.2	3.87	20.2	2.83	15.1	1.97
29		50.4	50.4	11.3	45.4	9.44	40.3	7.77	35.3	6.26	30.2	4.92	25.2	3.75	20.2	2.75	15.1	1.91
27		50.4	50.4	10.5	45.4	8.83	40.3	7.27	35.3	5.87	30.2	4.62	25.2	3.52	20.2	2.58	15.1	1.80
25		50.4	50.4	9.87	45.4	8.26	40.3	6.81	35.3	5.50	30.2	4.33	25.2	3.31	20.2	2.43	15.1	1.70
23		50.4	50.4	9.44	45.4	7.91	40.3	6.52	35.3	5.27	30.2	4.15	25.2	3.18	20.2	2.34	15.1	1.64
21		50.4	50.4	9.25	45.4	7.76	40.3	6.40	35.3	5.17	30.2	4.08	25.2	3.12	20.2	2.30	15.1	1.61
20		50.4	50.4	9.17	45.4	7.69	40.3	6.34	35.3	5.13	30.2	4.05	25.2	3.10	20.2	2.28	15.1	1.60
19		50.4	50.4	9.09	45.4	7.63	40.3	6.29	35.3	5.09	30.2	4.02	25.2	3.08	20.2	2.27	15.1	1.59
17		50.4	50.4	8.95	45.4	7.51	40.3	6.20	35.3	5.02	30.2	3.96	25.2	3.04	20.2	2.24	15.1	1.58
15		50.4	50.4	8.83	45.4	7.41	40.3	6.12	35.3	4.95	30.2	3.92	25.2	3.00	20.2	2.22	15.1	1.56

TC : Total Capacity PI : Power Input
 Indoor air temperature conditions : 27.0 °C dry-bulb / 19.0 °C wet-bulb

Heating			Compressor + Outdoor Fan Power consumption (kW)															
Outdoor Unit		Outdoor Unit 100% Cooling Capacity (kW)	100%		90%		80%		70%		60%		50%		40%		30%	
Dry-Bulb (°C)	Wet-Bulb (°C)		TC (kW)	PI (kW)	TC (kW)	PI (kW)	TC (kW)	PI (kW)	TC (kW)	PI (kW)	TC (kW)	PI (kW)	TC (kW)	PI (kW)	TC (kW)	PI (kW)	TC (kW)	PI (kW)
15.0	13.7	56.0	56.0	11.6	50.4	9.98	44.8	8.45	39.2	7.05	33.6	5.78	28.0	4.63	22.4	3.61	16.8	2.72
13.0	11.8	56.0	56.0	12.1	50.4	10.3	44.8	8.74	39.2	7.28	33.6	5.96	28.0	4.76	22.4	3.70	16.8	2.78
11.0	9.8	56.0	56.0	12.6	50.4	10.7	44.8	9.07	39.2	7.55	33.6	6.16	28.0	4.91	22.4	3.81	16.8	2.84
9.0	7.9	56.0	56.0	13.1	50.4	11.2	44.8	9.41	39.2	7.81	33.6	6.36	28.0	5.06	22.4	3.91	16.8	2.91
7.0	6.0	56.0	56.0	13.6	50.4	11.6	44.8	9.78	39.2	8.10	33.6	6.59	28.0	5.23	22.4	4.03	16.8	2.98
5.0	4.1	54.2	54.2	13.5	48.8	11.5	43.4	9.72	37.9	8.06	32.5	6.55	27.1	5.20	21.7	4.00	16.3	2.97
3.0	2.2	52.4	52.4	13.4	47.2	11.5	41.9	9.67	36.7	8.01	31.4	6.51	26.2	5.17	21.0	3.98	15.7	2.95
0.0	-0.7	49.6	49.6	13.3	44.7	11.4	39.7	9.58	34.8	7.94	29.8	6.45	24.8	5.12	19.9	3.95	14.9	2.92
-3.0	-3.7	46.8	46.8	13.2	42.1	11.3	37.4	9.49	32.8	7.87	28.1	6.40	23.4	5.08	18.7	3.91	14.0	2.90
-5.0	-5.6	45.0	45.0	13.1	40.5	11.2	36.0	9.44	31.5	7.82	27.0	6.36	22.5	5.05	18.0	3.89	13.5	2.88
-7.0	-7.6	43.1	43.1	13.0	38.8	11.1	34.5	9.38	30.2	7.77	25.9	6.32	21.6	5.02	17.2	3.86	12.9	2.86
-10	-10.5	40.4	40.4	12.9	36.3	11.0	32.3	9.29	28.3	7.70	24.2	6.26	20.2	4.97	16.1	3.83	12.1	2.83
-14.5	-15.0	36.1	36.1	12.7	32.5	10.9	28.9	9.16	25.3	7.59	21.7	6.17	18.0	4.90	14.4	3.77	10.8	2.79

TC : Total Capacity PI : Power Input
 Indoor air temperature conditions : 20.0 °C dry-bulb



MMY-MAP2016HT7P (20HP, 56kW system)

Cooling			Compressor + Outdoor Fan Power consumption (kW)															
Outdoor Unit Dry-Bulb (°C)		Outdoor Unit 100% Cooling Capacity (kW)	100%		90%		80%		70%		60%		50%		40%		30%	
			TC (kW)	PI (kW)	TC (kW)	PI (kW)	TC (kW)	PI (kW)	TC (kW)	PI (kW)	TC (kW)	PI (kW)	TC (kW)	PI (kW)	TC (kW)	PI (kW)	TC (kW)	PI (kW)
40		52.1	52.1	19.2	46.9	15.7	41.7	12.5	36.5	9.75	31.3	7.38	26.1	5.40	20.8	3.81	15.6	2.62
39		52.9	52.9	18.9	47.7	15.4	42.4	12.3	37.1	9.60	31.8	7.27	26.5	5.32	21.2	3.75	15.9	2.58
37		54.5	54.5	18.4	49.1	15.0	43.6	12.0	38.2	9.31	32.7	7.05	27.3	5.16	21.8	3.64	16.4	2.50
35		56.0	56.0	17.9	50.4	14.5	44.8	11.6	39.2	9.02	33.6	6.83	28.0	4.99	22.4	3.53	16.8	2.42
33		56.0	56.0	16.4	50.4	13.4	44.8	10.7	39.2	8.35	33.6	6.33	28.0	4.64	22.4	3.30	16.8	2.28
31		56.0	56.0	15.2	50.4	12.4	44.8	9.93	39.2	7.75	33.6	5.89	28.0	4.33	22.4	3.09	16.8	2.15
30		56.0	56.0	14.7	50.4	12.0	44.8	9.58	39.2	7.48	33.6	5.68	28.0	4.19	22.4	2.99	16.8	2.09
29		56.0	56.0	14.1	50.4	11.5	44.8	9.24	39.2	7.22	33.6	5.49	28.0	4.05	22.4	2.90	16.8	2.03
27		56.0	56.0	13.2	50.4	10.8	44.8	8.61	39.2	6.73	33.6	5.13	28.0	3.79	22.4	2.72	16.8	1.92
25		56.0	56.0	12.3	50.4	10.0	44.8	8.03	39.2	6.29	33.6	4.80	28.0	3.55	22.4	2.56	16.8	1.82
23		56.0	56.0	11.7	50.4	9.57	44.8	7.67	39.2	6.01	33.6	4.59	28.0	3.41	22.4	2.46	16.8	1.75
21		56.0	56.0	11.4	50.4	9.36	44.8	7.50	39.2	5.88	33.6	4.50	28.0	3.34	22.4	2.42	16.8	1.73
20		56.0	56.0	11.3	50.4	9.26	44.8	7.43	39.2	5.83	33.6	4.46	28.0	3.32	22.4	2.40	16.8	1.72
19		56.0	56.0	11.2	50.4	9.17	44.8	7.36	39.2	5.78	33.6	4.42	28.0	3.29	22.4	2.39	16.8	1.71
17		56.0	56.0	11.0	50.4	9.02	44.8	7.24	39.2	5.68	33.6	4.35	28.0	3.24	22.4	2.36	16.8	1.70
15		56.0	56.0	10.9	50.4	8.88	44.8	7.13	39.2	5.60	33.6	4.29	28.0	3.20	22.4	2.34	16.8	1.69

TC : Total Capacity PI : Power Input
 Indoor air temperature conditions : 27.0 °C dry-bulb / 19.0 °C wet-bulb

Heating			Compressor + Outdoor Fan Power consumption (kW)															
Outdoor Unit		Outdoor Unit 100% Cooling Capacity (kW)	100%		90%		80%		70%		60%		50%		40%		30%	
Dry-Bulb (°C)	Wet-Bulb (°C)		TC (kW)	PI (kW)	TC (kW)	PI (kW)	TC (kW)	PI (kW)	TC (kW)	PI (kW)	TC (kW)	PI (kW)	TC (kW)	PI (kW)	TC (kW)	PI (kW)	TC (kW)	PI (kW)
15.0	13.7	63.0	63.0	14.1	56.7	12.1	50.4	10.2	44.1	8.49	37.8	6.92	31.5	5.49	25.2	4.20	18.9	3.07
13.0	11.8	63.0	63.0	14.6	56.7	12.5	50.4	10.6	44.1	8.78	37.8	7.14	31.5	5.65	25.2	4.32	18.9	3.14
11.0	9.8	63.0	63.0	15.2	56.7	13.0	50.4	11.0	44.1	9.11	37.8	7.39	31.5	5.84	25.2	4.45	18.9	3.23
9.0	7.9	63.0	63.0	15.8	56.7	13.5	50.4	11.4	44.1	9.44	37.8	7.65	31.5	6.03	25.2	4.59	18.9	3.32
7.0	6.0	63.0	63.0	16.5	56.7	14.1	50.4	11.8	44.1	9.80	37.8	7.93	31.5	6.24	25.2	4.73	18.9	3.41
5.0	4.1	60.7	60.7	16.4	54.7	14.0	48.6	11.8	42.5	9.72	36.4	7.87	30.4	6.19	24.3	4.70	18.2	3.38
3.0	2.2	58.5	58.5	16.2	52.6	13.9	46.8	11.7	40.9	9.65	35.1	7.81	29.2	6.14	23.4	4.66	17.5	3.36
0.0	-0.7	55.0	55.0	16.1	49.5	13.7	44.0	11.5	38.5	9.53	33.0	7.71	27.5	6.07	22.0	4.61	16.5	3.32
-3.0	-3.7	51.5	51.5	15.9	46.3	13.5	41.2	11.4	36.0	9.42	30.9	7.62	25.7	6.00	20.6	4.55	15.4	3.28
-5.0	-5.6	49.2	49.2	15.7	44.3	13.4	39.4	11.3	34.5	9.34	29.5	7.56	24.6	5.95	19.7	4.51	14.8	3.25
-7.0	-7.6	46.9	46.9	15.6	42.2	13.3	37.5	11.2	32.8	9.26	28.1	7.49	23.4	5.90	18.7	4.48	14.1	3.23
-10	-10.5	43.4	43.4	15.4	39.1	13.2	34.7	11.1	30.4	9.15	26.0	7.40	21.7	5.83	17.4	4.42	13.0	3.19
-14.5	-15.0	38.1	38.1	15.1	34.3	12.9	30.5	10.9	26.6	8.97	22.8	7.26	19.0	5.71	15.2	4.34	11.4	3.12

TC : Total Capacity PI : Power Input
 Indoor air temperature conditions : 20.0 °C dry-bulb



MMY-MAP2216HT7P (22HP, 61.5kW system)

Cooling			Compressor + Outdoor Fan Power consumption (kW)															
Outdoor Unit Dry-Bulb (°C)		Outdoor Unit 100% Cooling Capacity (kW)	100%		90%		80%		70%		60%		50%		40%		30%	
			TC (kW)	PI (kW)	TC (kW)	PI (kW)	TC (kW)	PI (kW)	TC (kW)	PI (kW)	TC (kW)	PI (kW)	TC (kW)	PI (kW)	TC (kW)	PI (kW)	TC (kW)	PI (kW)
40		57.2	57.2	22.7	51.5	18.5	45.8	14.7	40.1	11.4	34.3	8.59	28.6	6.22	22.9	4.31	17.2	2.86
39		58.2	58.2	22.4	52.3	18.2	46.5	14.5	40.7	11.3	34.9	8.47	29.1	6.13	23.3	4.25	17.4	2.82
37		59.9	59.9	21.7	53.9	17.6	47.9	14.1	41.9	10.9	35.9	8.21	29.9	5.94	24.0	4.12	18.0	2.73
35		61.5	61.5	21.0	55.4	17.1	49.2	13.6	43.1	10.6	36.9	7.95	30.8	5.76	24.6	3.99	18.5	2.65
33		61.5	61.5	19.4	55.4	15.8	49.2	12.6	43.1	9.78	36.9	7.37	30.8	5.35	24.6	3.72	18.5	2.48
31		61.5	61.5	18.0	55.4	14.6	49.2	11.7	43.1	9.08	36.9	6.85	30.8	4.98	24.6	3.47	18.5	2.33
30		61.5	61.5	17.3	55.4	14.1	49.2	11.2	43.1	8.75	36.9	6.61	30.8	4.81	24.6	3.36	18.5	2.26
29		61.5	61.5	16.7	55.4	13.6	49.2	10.8	43.1	8.44	36.9	6.38	30.8	4.65	24.6	3.25	18.5	2.20
27		61.5	61.5	15.5	55.4	12.7	49.2	10.1	43.1	7.87	36.9	5.95	30.8	4.34	24.6	3.05	18.5	2.07
25		61.5	61.5	14.5	55.4	11.8	49.2	9.43	43.1	7.35	36.9	5.56	30.8	4.07	24.6	2.86	18.5	1.95
23		61.5	61.5	13.8	55.4	11.3	49.2	9.00	43.1	7.02	36.9	5.32	30.8	3.89	24.6	2.75	18.5	1.88
21		61.5	61.5	13.5	55.4	11.0	49.2	8.80	43.1	6.87	36.9	5.21	30.8	3.82	24.6	2.70	18.5	1.86
20		61.5	61.5	13.3	55.4	10.9	49.2	8.71	43.1	6.80	36.9	5.16	30.8	3.79	24.6	2.68	18.5	1.85
19		61.5	61.5	13.2	55.4	10.8	49.2	8.63	43.1	6.74	36.9	5.11	30.8	3.75	24.6	2.66	18.5	1.83
17		61.5	61.5	13.0	55.4	10.6	49.2	8.48	43.1	6.63	36.9	5.03	30.8	3.70	24.6	2.63	18.5	1.82
15		61.5	61.5	12.8	55.4	10.4	49.2	8.36	43.1	6.53	36.9	4.96	30.8	3.65	24.6	2.60	18.5	1.80

TC : Total Capacity PI : Power Input
 Indoor air temperature conditions : 27.0 °C dry-bulb / 19.0 °C wet-bulb

Heating			Compressor + Outdoor Fan Power consumption (kW)															
Outdoor Unit		Outdoor Unit 100% Cooling Capacity (kW)	100%		90%		80%		70%		60%		50%		40%		30%	
Dry-Bulb (°C)	Wet-Bulb (°C)		TC (kW)	PI (kW)	TC (kW)	PI (kW)	TC (kW)	PI (kW)	TC (kW)	PI (kW)	TC (kW)	PI (kW)	TC (kW)	PI (kW)	TC (kW)	PI (kW)	TC (kW)	PI (kW)
15.0	13.7	64.0	64.0	14.2	57.6	12.2	51.2	10.3	44.8	8.57	38.4	6.99	32.0	5.56	25.6	4.27	19.2	3.13
13.0	11.8	64.0	64.0	14.7	57.6	12.6	51.2	10.7	44.8	8.86	38.4	7.21	32.0	5.72	25.6	4.39	19.2	3.21
11.0	9.8	64.0	64.0	15.3	57.6	13.1	51.2	11.1	44.8	9.19	38.4	7.47	32.0	5.91	25.6	4.52	19.2	3.30
9.0	7.9	64.0	64.0	15.9	57.6	13.6	51.2	11.5	44.8	9.52	38.4	7.72	32.0	6.10	25.6	4.66	19.2	3.38
7.0	6.0	64.0	64.0	16.6	57.6	14.2	51.2	11.9	44.8	9.88	38.4	8.00	32.0	6.31	25.6	4.80	19.2	3.48
5.0	4.1	61.7	61.7	16.5	55.5	14.1	49.4	11.8	43.2	9.80	37.0	7.94	30.9	6.26	24.7	4.77	18.5	3.45
3.0	2.2	59.4	59.4	16.3	53.5	14.0	47.5	11.8	41.6	9.73	35.6	7.88	29.7	6.22	23.8	4.73	17.8	3.43
0.0	-0.7	55.9	55.9	16.2	50.3	13.8	44.7	11.6	39.1	9.61	33.6	7.79	28.0	6.14	22.4	4.67	16.8	3.39
-3.0	-3.7	52.3	52.3	16.0	47.1	13.6	41.8	11.5	36.6	9.49	31.4	7.69	26.1	6.07	20.9	4.62	15.7	3.34
-5.0	-5.6	50.0	50.0	15.8	45.0	13.5	40.0	11.4	35.0	9.42	30.0	7.63	25.0	6.02	20.0	4.58	15.0	3.32
-7.0	-7.6	47.6	47.6	15.7	42.8	13.4	38.1	11.3	33.3	9.34	28.6	7.57	23.8	5.97	19.0	4.54	14.3	3.29
-10	-10.5	44.1	44.1	15.5	39.7	13.2	35.3	11.1	30.9	9.22	26.5	7.47	22.0	5.89	17.6	4.49	13.2	3.25
-14.5	-15.0	38.7	38.7	15.2	34.8	13.0	30.9	10.9	27.1	9.05	23.2	7.33	19.3	5.78	15.5	4.40	11.6	3.19

TC : Total Capacity PI : Power Input
 Indoor air temperature conditions : 20.0 °C dry-bulb



MMY-AP2416HT7P (24HP, 67kW system)

Cooling			Compressor + Outdoor Fan Power consumption (kW)															
Outdoor Unit Dry-Bulb (°C)		Outdoor Unit 100% Cooling Capacity (kW)	100%		90%		80%		70%		60%		50%		40%		30%	
			TC (kW)	PI (kW)	TC (kW)	PI (kW)	TC (kW)	PI (kW)	TC (kW)	PI (kW)	TC (kW)	PI (kW)	TC (kW)	PI (kW)	TC (kW)	PI (kW)	TC (kW)	PI (kW)
40		62.3	62.3	20.3	56.1	16.8	49.9	13.6	43.6	10.8	37.4	8.30	31.2	6.18	24.9	4.42	18.7	3.01
39		63.4	63.4	20.0	57.0	16.5	50.7	13.4	44.3	10.6	38.0	8.17	31.7	6.09	25.3	4.35	19.0	2.97
37		65.2	65.2	19.4	58.7	16.0	52.2	13.0	45.7	10.3	39.1	7.93	32.6	5.90	26.1	4.22	19.6	2.88
35		67.0	67.0	18.8	60.3	15.5	53.6	12.6	46.9	9.97	40.2	7.68	33.5	5.72	26.8	4.09	20.1	2.79
33		67.0	67.0	17.4	60.3	14.4	53.6	11.7	46.9	9.25	40.2	7.14	33.5	5.33	26.8	3.82	20.1	2.62
31		67.0	67.0	16.2	60.3	13.4	53.6	10.9	46.9	8.61	40.2	6.65	33.5	4.98	26.8	3.58	20.1	2.46
30		67.0	67.0	15.6	60.3	12.9	53.6	10.5	46.9	8.32	40.2	6.43	33.5	4.81	26.8	3.47	20.1	2.39
29		67.0	67.0	15.1	60.3	12.5	53.6	10.1	46.9	8.04	40.2	6.22	33.5	4.66	26.8	3.36	20.1	2.32
27		67.0	67.0	14.1	60.3	11.6	53.6	9.45	46.9	7.51	40.2	5.82	33.5	4.36	26.8	3.16	20.1	2.19
25		67.0	67.0	13.1	60.3	10.9	53.6	8.84	46.9	7.03	40.2	5.45	33.5	4.10	26.8	2.97	20.1	2.07
23		67.0	67.0	12.5	60.3	10.4	53.6	8.45	46.9	6.73	40.2	5.22	33.5	3.93	26.8	2.85	20.1	1.99
21		67.0	67.0	12.3	60.3	10.2	53.6	8.28	46.9	6.60	40.2	5.12	33.5	3.86	26.8	2.81	20.1	1.96
20		67.0	67.0	12.2	60.3	10.1	53.6	8.20	46.9	6.54	40.2	5.08	33.5	3.83	26.8	2.79	20.1	1.95
19		67.0	67.0	12.0	60.3	9.99	53.6	8.13	46.9	6.48	40.2	5.04	33.5	3.80	26.8	2.77	20.1	1.94
17		67.0	67.0	11.9	60.3	9.83	53.6	8.00	46.9	6.38	40.2	4.96	33.5	3.75	26.8	2.73	20.1	1.94
15		67.0	67.0	11.7	60.3	9.69	53.6	7.90	46.9	6.30	40.2	4.90	33.5	3.70	26.8	2.70	20.1	1.94

TC : Total Capacity PI : Power Input
 Indoor air temperature conditions : 27.0 °C dry-bulb / 19.0 °C wet-bulb

Heating			Compressor + Outdoor Fan Power consumption (kW)																
Outdoor Unit Dry-Bulb (°C)		Outdoor Unit Wet-Bulb (°C)	Outdoor Unit 100% Cooling Capacity (kW)	100%		90%		80%		70%		60%		50%		40%		30%	
				TC (kW)	PI (kW)	TC (kW)	PI (kW)	TC (kW)	PI (kW)	TC (kW)	PI (kW)	TC (kW)	PI (kW)	TC (kW)	PI (kW)	TC (kW)	PI (kW)	TC (kW)	PI (kW)
15.0	13.7	75.0	75.0	15.8	67.5	13.5	60.0	11.3	52.5	9.42	45.0	7.66	37.5	6.09	30.0	4.70	22.5	3.49	
13.0	11.8	75.0	75.0	16.4	67.5	14.0	60.0	11.8	52.5	9.74	45.0	7.91	37.5	6.28	30.0	4.83	22.5	3.57	
11.0	9.8	75.0	75.0	17.0	67.5	14.5	60.0	12.2	52.5	10.1	45.0	8.19	37.5	6.48	30.0	4.97	22.5	3.66	
9.0	7.9	75.0	75.0	17.7	67.5	15.1	60.0	12.7	52.5	10.5	45.0	8.47	37.5	6.69	30.0	5.12	22.5	3.76	
7.0	6.0	75.0	75.0	18.5	67.5	15.7	60.0	13.2	52.5	10.9	45.0	8.78	37.5	6.92	30.0	5.28	22.5	3.86	
5.0	4.1	72.3	72.3	18.3	65.1	15.6	57.9	13.1	50.6	10.8	43.4	8.72	36.2	6.86	28.9	5.24	21.7	3.83	
3.0	2.2	69.6	69.6	18.2	62.7	15.5	55.7	13.0	48.7	10.7	41.8	8.65	34.8	6.81	27.9	5.19	20.9	3.80	
0.0	-0.7	65.5	65.5	18.0	59.0	15.3	52.4	12.8	45.9	10.6	39.3	8.55	32.8	6.73	26.2	5.13	19.7	3.75	
-3.0	-3.7	61.3	61.3	17.8	55.2	15.1	49.0	12.7	42.9	10.4	36.8	8.44	30.6	6.65	24.5	5.07	18.4	3.71	
-5.0	-5.6	58.6	58.6	17.6	52.7	15.0	46.9	12.6	41.0	10.4	35.2	8.38	29.3	6.60	23.4	5.03	17.6	3.68	
-7.0	-7.6	55.8	55.8	17.5	50.2	14.9	44.6	12.5	39.0	10.3	33.5	8.30	27.9	6.54	22.3	4.99	16.7	3.65	
-10	-10.5	51.7	51.7	17.3	46.5	14.7	41.3	12.3	36.2	10.2	31.0	8.20	25.8	6.46	20.7	4.93	15.5	3.60	
-14.5	-15.0	45.3	45.3	16.9	40.8	14.4	36.3	12.1	31.7	9.96	27.2	8.04	22.7	6.34	18.1	4.83	13.6	3.53	

TC : Total Capacity PI : Power Input
 Indoor air temperature conditions : 20.0 °C dry-bulb



MMY-AP2616HT7P (26HP, 73.5kW system)

Cooling			Compressor + Outdoor Fan Power consumption (kW)															
Outdoor Unit Dry-Bulb (°C)		Outdoor Unit 100% Cooling Capacity (kW)	100%		90%		80%		70%		60%		50%		40%		30%	
			TC (kW)	PI (kW)	TC (kW)	PI (kW)	TC (kW)	PI (kW)	TC (kW)	PI (kW)	TC (kW)	PI (kW)	TC (kW)	PI (kW)	TC (kW)	PI (kW)	TC (kW)	PI (kW)
40		68.4	68.4	22.6	61.6	18.7	54.7	15.1	47.9	12.0	41.0	9.23	34.2	6.88	27.4	4.93	20.5	3.38
39		69.5	69.5	22.3	62.5	18.4	55.6	14.9	48.6	11.8	41.7	9.09	34.7	6.78	27.8	4.86	20.8	3.33
37		71.6	71.6	21.6	64.4	17.8	57.3	14.4	50.1	11.4	42.9	8.82	35.8	6.58	28.6	4.71	21.5	3.22
35		73.5	73.5	20.9	66.2	17.3	58.8	14.0	51.5	11.1	44.1	8.54	36.8	6.37	29.4	4.56	22.1	3.12
33		73.5	73.5	19.4	66.2	16.0	58.8	13.0	51.5	10.3	44.1	7.94	36.8	5.94	29.4	4.27	22.1	2.94
31		73.5	73.5	18.0	66.2	14.9	58.8	12.1	51.5	9.58	44.1	7.41	36.8	5.55	29.4	4.00	22.1	2.76
30		73.5	73.5	17.3	66.2	14.3	58.8	11.6	51.5	9.25	44.1	7.16	36.8	5.36	29.4	3.87	22.1	2.68
29		73.5	73.5	16.7	66.2	13.9	58.8	11.2	51.5	8.94	44.1	6.92	36.8	5.19	29.4	3.75	22.1	2.61
27		73.5	73.5	15.6	66.2	12.9	58.8	10.5	51.5	8.36	44.1	6.48	36.8	4.87	29.4	3.53	22.1	2.46
25		73.5	73.5	14.6	66.2	12.1	58.8	9.82	51.5	7.82	44.1	6.07	36.8	4.57	29.4	3.32	22.1	2.32
23		73.5	73.5	13.9	66.2	11.5	58.8	9.40	51.5	7.49	44.1	5.81	36.8	4.38	29.4	3.19	22.1	2.24
21		73.5	73.5	13.6	66.2	11.3	58.8	9.21	51.5	7.34	44.1	5.70	36.8	4.30	29.4	3.14	22.1	2.21
20		73.5	73.5	13.5	66.2	11.2	58.8	9.12	51.5	7.27	44.1	5.66	36.8	4.27	29.4	3.12	22.1	2.19
19		73.5	73.5	13.4	66.2	11.1	58.8	9.04	51.5	7.21	44.1	5.61	36.8	4.24	29.4	3.10	22.1	2.18
17		73.5	73.5	13.2	66.2	10.9	58.8	8.90	51.5	7.10	44.1	5.53	36.8	4.18	29.4	3.06	22.1	2.17
15		73.5	73.5	13.0	66.2	10.8	58.8	8.78	51.5	7.01	44.1	5.46	36.8	4.13	29.4	3.03	22.1	2.16

TC : Total Capacity PI : Power Input
 Indoor air temperature conditions : 27.0 °C dry-bulb / 19.0 °C wet-bulb

Heating			Compressor + Outdoor Fan Power consumption (kW)															
Outdoor Unit Dry-Bulb (°C) / Wet-Bulb (°C)		Outdoor Unit 100% Cooling Capacity (kW)	100%		90%		80%		70%		60%		50%		40%		30%	
			TC (kW)	PI (kW)	TC (kW)	PI (kW)	TC (kW)	PI (kW)	TC (kW)	PI (kW)	TC (kW)	PI (kW)	TC (kW)	PI (kW)	TC (kW)	PI (kW)	TC (kW)	PI (kW)
15.0	13.7	82.5	82.5	16.8	74.3	14.3	66.0	12.0	57.8	9.93	49.5	8.12	41.3	6.54	33.0	5.20	24.8	4.10
13.0	11.8	82.5	82.5	17.5	74.3	14.8	66.0	12.4	57.8	10.3	49.5	8.37	41.3	6.72	33.0	5.32	24.8	4.17
11.0	9.8	82.5	82.5	18.2	74.3	15.4	66.0	12.9	57.8	10.6	49.5	8.65	41.3	6.92	33.0	5.45	24.8	4.24
9.0	7.9	82.5	82.5	19.0	74.3	16.1	66.0	13.4	57.8	11.0	49.5	8.95	41.3	7.13	33.0	5.59	24.8	4.32
7.0	6.0	82.5	82.5	19.8	74.3	16.8	66.0	14.0	57.8	11.5	49.5	9.27	41.3	7.36	33.0	5.74	24.8	4.41
5.0	4.1	79.7	79.7	19.7	71.7	16.6	63.8	13.9	55.8	11.4	47.8	9.21	39.9	7.31	31.9	5.70	23.9	4.38
3.0	2.2	76.9	76.9	19.6	69.2	16.5	61.5	13.8	53.8	11.3	46.2	9.15	38.5	7.26	30.8	5.66	23.1	4.35
0.0	-0.7	72.7	72.7	19.4	65.4	16.4	58.1	13.6	50.9	11.2	43.6	9.05	36.3	7.18	29.1	5.60	21.8	4.31
-3.0	-3.7	68.3	68.3	19.2	61.4	16.2	54.6	13.5	47.8	11.1	41.0	8.96	34.1	7.11	27.3	5.54	20.5	4.26
-5.0	-5.6	65.5	65.5	19.0	58.9	16.1	52.4	13.4	45.8	11.0	39.3	8.89	32.7	7.06	26.2	5.51	19.6	4.23
-7.0	-7.6	62.5	62.5	18.9	56.3	16.0	50.0	13.3	43.8	10.9	37.5	8.83	31.3	7.01	25.0	5.47	18.8	4.20
-10	-10.5	58.3	58.3	18.7	52.4	15.8	46.6	13.2	40.8	10.8	35.0	8.74	29.1	6.93	23.3	5.41	17.5	4.16
-14.5	-15.0	51.7	51.7	18.4	46.5	15.5	41.3	12.9	36.2	10.6	31.0	8.59	25.8	6.82	20.7	5.32	15.5	4.09

TC : Total Capacity PI : Power Input
 Indoor air temperature conditions : 20.0 °C dry-bulb



MMY-AP2816HT7P (28HP, 78.5kW system)

Cooling			Compressor + Outdoor Fan Power consumption (kW)															
Outdoor Unit Dry-Bulb (°C)		Outdoor Unit 100% Cooling Capacity (kW)	100%		90%		80%		70%		60%		50%		40%		30%	
			TC (kW)	PI (kW)	TC (kW)	PI (kW)	TC (kW)	PI (kW)	TC (kW)	PI (kW)	TC (kW)	PI (kW)	TC (kW)	PI (kW)	TC (kW)	PI (kW)	TC (kW)	PI (kW)
40		73.1	73.1	24.9	65.7	20.5	58.4	16.5	51.1	13.1	43.8	10.0	36.5	7.40	29.2	5.24	21.9	3.52
39		74.2	74.2	24.5	66.8	20.2	59.4	16.3	52.0	12.9	44.5	9.86	37.1	7.29	29.7	5.16	22.3	3.47
37		76.4	76.4	23.7	68.8	19.6	61.2	15.8	53.5	12.5	45.9	9.56	38.2	7.07	30.6	5.00	22.9	3.36
35		78.5	78.5	23.0	70.7	19.0	62.8	15.3	55.0	12.1	47.1	9.26	39.3	6.85	31.4	4.85	23.6	3.26
33		78.5	78.5	21.3	70.7	17.6	62.8	14.2	55.0	11.2	47.1	8.60	39.3	6.37	31.4	4.53	23.6	3.06
31		78.5	78.5	19.8	70.7	16.3	62.8	13.2	55.0	10.4	47.1	8.01	39.3	5.95	31.4	4.24	23.6	2.88
30		78.5	78.5	19.1	70.7	15.7	62.8	12.7	55.0	10.1	47.1	7.74	39.3	5.75	31.4	4.10	23.6	2.79
29		78.5	78.5	18.4	70.7	15.2	62.8	12.3	55.0	9.72	47.1	7.48	39.3	5.56	31.4	3.97	23.6	2.71
27		78.5	78.5	17.2	70.7	14.2	62.8	11.5	55.0	9.08	47.1	6.99	39.3	5.21	31.4	3.73	23.6	2.55
25		78.5	78.5	16.0	70.7	13.2	62.8	10.7	55.0	8.49	47.1	6.55	39.3	4.89	31.4	3.50	23.6	2.40
23		78.5	78.5	15.3	70.7	12.6	62.8	10.2	55.0	8.13	47.1	6.27	39.3	4.68	31.4	3.37	23.6	2.32
21		78.5	78.5	15.0	70.7	12.4	62.8	10.0	55.0	7.96	47.1	6.15	39.3	4.60	31.4	3.31	23.6	2.28
20		78.5	78.5	14.8	70.7	12.3	62.8	9.94	55.0	7.89	47.1	6.10	39.3	4.56	31.4	3.29	23.6	2.27
19		78.5	78.5	14.7	70.7	12.1	62.8	9.85	55.0	7.82	47.1	6.05	39.3	4.53	31.4	3.26	23.6	2.26
17		78.5	78.5	14.4	70.7	11.9	62.8	9.70	55.0	7.70	47.1	5.96	39.3	4.46	31.4	3.22	23.6	2.24
15		78.5	78.5	14.2	70.7	11.8	62.8	9.56	55.0	7.60	47.1	5.88	39.3	4.41	31.4	3.19	23.6	2.23

TC : Total Capacity PI : Power Input
 Indoor air temperature conditions : 27.0 °C dry-bulb / 19.0 °C wet-bulb

Heating			Compressor + Outdoor Fan Power consumption (kW)															
Outdoor Unit		Outdoor Unit 100% Cooling Capacity (kW)	100%		90%		80%		70%		60%		50%		40%		30%	
Dry-Bulb (°C)	Wet-Bulb (°C)		TC (kW)	PI (kW)	TC (kW)	PI (kW)	TC (kW)	PI (kW)	TC (kW)	PI (kW)	TC (kW)	PI (kW)	TC (kW)	PI (kW)	TC (kW)	PI (kW)	TC (kW)	PI (kW)
15.0	13.7	87.5	87.5	18.4	78.8	15.6	70.0	13.0	61.3	10.8	52.5	8.79	43.8	7.06	35.0	5.59	26.3	4.39
13.0	11.8	87.5	87.5	19.1	78.8	16.2	70.0	13.5	61.3	11.2	52.5	9.07	43.8	7.25	35.0	5.72	26.3	4.46
11.0	9.8	87.5	87.5	19.9	78.8	16.9	70.0	14.1	61.3	11.6	52.5	9.38	43.8	7.48	35.0	5.87	26.3	4.55
9.0	7.9	87.5	87.5	20.8	78.8	17.6	70.0	14.6	61.3	12.0	52.5	9.71	43.8	7.71	35.0	6.02	26.3	4.63
7.0	6.0	87.5	87.5	21.7	78.8	18.3	70.0	15.2	61.3	12.5	52.5	10.1	43.8	7.96	35.0	6.18	26.3	4.73
5.0	4.1	84.4	84.4	21.6	75.9	18.2	67.5	15.1	59.1	12.4	50.6	10.0	42.2	7.90	33.7	6.13	25.3	4.69
3.0	2.2	81.2	81.2	21.4	73.1	18.0	65.0	15.0	56.9	12.3	48.7	9.91	40.6	7.83	32.5	6.08	24.4	4.66
0.0	-0.7	76.4	76.4	21.2	68.8	17.8	61.2	14.8	53.5	12.2	45.9	9.79	38.2	7.74	30.6	6.01	22.9	4.60
-3.0	-3.7	71.5	71.5	20.9	64.4	17.6	57.2	14.7	50.1	12.0	42.9	9.67	35.8	7.65	28.6	5.94	21.5	4.54
-5.0	-5.6	68.4	68.4	20.7	61.5	17.5	54.7	14.5	47.9	11.9	41.0	9.59	34.2	7.59	27.3	5.89	20.5	4.51
-7.0	-7.6	65.1	65.1	20.6	58.6	17.3	52.1	14.4	45.5	11.8	39.0	9.51	32.5	7.52	26.0	5.84	19.5	4.47
-10	-10.5	60.3	60.3	20.3	54.3	17.1	48.2	14.2	42.2	11.7	36.2	9.40	30.1	7.43	24.1	5.77	18.1	4.42
-14.5	-15.0	52.9	52.9	19.9	47.6	16.8	42.3	14.0	37.0	11.4	31.7	9.21	26.4	7.29	21.1	5.66	15.9	4.33

TC : Total Capacity PI : Power Input
 Indoor air temperature conditions : 20.0 °C dry-bulb



MMY-AP3016HT7P (30HP, 85kW system)

Cooling			Compressor + Outdoor Fan Power consumption (kW)														
Outdoor Unit Dry-Bulb (°C)	Outdoor Unit 100% Cooling Capacity (kW)	100%		90%		80%		70%		60%		50%		40%		30%	
		TC	PI	TC	PI	TC	PI	TC	PI	TC	PI	TC	PI	TC	PI	TC	PI
		(kW)	(kW)	(kW)	(kW)	(kW)	(kW)	(kW)	(kW)	(kW)	(kW)	(kW)	(kW)	(kW)	(kW)	(kW)	(kW)
40	79.1	79.1	27.1	71.2	22.3	63.3	18.1	55.4	14.3	47.5	10.9	39.5	8.10	31.6	5.75	23.7	3.89
39	80.4	80.4	26.7	72.3	22.0	64.3	17.8	56.3	14.0	48.2	10.8	40.2	7.98	32.1	5.67	24.1	3.83
37	82.8	82.8	25.9	74.5	21.3	66.2	17.3	57.9	13.6	49.7	10.5	41.4	7.74	33.1	5.50	24.8	3.71
35	85.0	85.0	25.1	76.5	20.7	68.0	16.7	59.5	13.2	51.0	10.1	42.5	7.50	34.0	5.32	25.5	3.60
33	85.0	85.0	23.2	76.5	19.2	68.0	15.5	59.5	12.2	51.0	9.41	42.5	6.98	34.0	4.97	25.5	3.38
31	85.0	85.0	21.6	76.5	17.8	68.0	14.4	59.5	11.4	51.0	8.76	42.5	6.52	34.0	4.66	25.5	3.18
30	85.0	85.0	20.8	76.5	17.2	68.0	13.9	59.5	11.0	51.0	8.47	42.5	6.30	34.0	4.51	25.5	3.08
29	85.0	85.0	20.1	76.5	16.6	68.0	13.4	59.5	10.6	51.0	8.18	42.5	6.10	34.0	4.37	25.5	2.99
27	85.0	85.0	18.7	76.5	15.5	68.0	12.5	59.5	9.92	51.0	7.65	42.5	5.71	34.0	4.10	25.5	2.82
25	85.0	85.0	17.5	76.5	14.4	68.0	11.7	59.5	9.28	51.0	7.17	42.5	5.36	34.0	3.85	25.5	2.66
23	85.0	85.0	16.7	76.5	13.8	68.0	11.2	59.5	8.88	51.0	6.86	42.5	5.14	34.0	3.70	25.5	2.56
21	85.0	85.0	16.3	76.5	13.5	68.0	11.0	59.5	8.70	51.0	6.73	42.5	5.04	34.0	3.64	25.5	2.53
20	85.0	85.0	16.2	76.5	13.4	68.0	10.9	59.5	8.63	51.0	6.67	42.5	5.00	34.0	3.62	25.5	2.51
19	85.0	85.0	16.0	76.5	13.3	68.0	10.8	59.5	8.55	51.0	6.62	42.5	4.96	34.0	3.59	25.5	2.50
17	85.0	85.0	15.8	76.5	13.0	68.0	10.6	59.5	8.42	51.0	6.52	42.5	4.90	34.0	3.55	25.5	2.47
15	85.0	85.0	15.5	76.5	12.9	68.0	10.4	59.5	8.31	51.0	6.44	42.5	4.84	34.0	3.51	25.5	2.45

TC : Total Capacity PI : Power Input
 Indoor air temperature conditions : 27.0 °C dry-bulb / 19.0 °C wet-bulb

Heating			Compressor + Outdoor Fan Power consumption (kW)															
Outdoor Unit		Outdoor Unit 100% Cooling Capacity (kW)	100%		90%		80%		70%		60%		50%		40%		30%	
Dry-Bulb (°C)	Wet-Bulb (°C)		TC	PI	TC	PI	TC	PI	TC	PI	TC	PI	TC	PI	TC	PI	TC	PI
(°C)	(°C)		(kW)	(kW)	(kW)	(kW)	(kW)	(kW)	(kW)	(kW)	(kW)	(kW)	(kW)	(kW)	(kW)	(kW)	(kW)	(kW)
15.0	13.7	95.0	95.0	19.4	85.5	16.4	76.0	13.7	66.5	11.3	57.0	9.25	47.5	7.51	38.0	6.09	28.5	4.99
13.0	11.8	95.0	95.0	20.2	85.5	17.0	76.0	14.2	66.5	11.7	57.0	9.53	47.5	7.70	38.0	6.21	28.5	5.05
11.0	9.8	95.0	95.0	21.1	85.5	17.8	76.0	14.8	66.5	12.1	57.0	9.85	47.5	7.92	38.0	6.34	28.5	5.12
9.0	7.9	95.0	95.0	22.1	85.5	18.5	76.0	15.4	66.5	12.6	57.0	10.2	47.5	8.15	38.0	6.48	28.5	5.20
7.0	6.0	95.0	95.0	23.1	85.5	19.4	76.0	16.0	66.5	13.1	57.0	10.5	47.5	8.39	38.0	6.64	28.5	5.28
5.0	4.1	91.8	91.8	22.9	82.6	19.2	73.4	15.9	64.2	13.0	55.1	10.5	45.9	8.34	36.7	6.59	27.5	5.24
3.0	2.2	88.5	88.5	22.8	79.7	19.1	70.8	15.8	62.0	12.9	53.1	10.4	44.3	8.28	35.4	6.55	26.6	5.21
0.0	-0.7	83.6	83.6	22.5	75.2	18.9	66.9	15.6	58.5	12.8	50.1	10.3	41.8	8.20	33.4	6.48	25.1	5.15
-3.0	-3.7	78.5	78.5	22.3	70.6	18.7	62.8	15.5	54.9	12.6	47.1	10.2	39.2	8.11	31.4	6.41	23.5	5.10
-5.0	-5.6	75.2	75.2	22.1	67.7	18.6	60.2	15.4	52.7	12.6	45.1	10.1	37.6	8.05	30.1	6.37	22.6	5.06
-7.0	-7.6	71.8	71.8	22.0	64.6	18.4	57.5	15.3	50.3	12.5	43.1	10.0	35.9	7.99	28.7	6.32	21.5	5.03
-10	-10.5	66.9	66.9	21.7	60.2	18.2	53.5	15.1	46.8	12.3	40.1	9.93	33.4	7.90	26.8	6.25	20.1	4.97
-14.5	-15.0	59.2	59.2	21.4	53.3	17.9	47.4	14.8	41.5	12.1	35.5	9.76	29.6	7.77	23.7	6.15	17.8	4.89

TC : Total Capacity PI : Power Input
 Indoor air temperature conditions : 20.0 °C dry-bulb



MMY-AP3216HT7P (32HP, 90kW system)

Cooling			Compressor + Outdoor Fan Power consumption (kW)															
Outdoor Unit Dry-Bulb (°C)		Outdoor Unit 100% Cooling Capacity (kW)	100%		90%		80%		70%		60%		50%		40%		30%	
			TC (kW)	PI (kW)	TC (kW)	PI (kW)	TC (kW)	PI (kW)	TC (kW)	PI (kW)	TC (kW)	PI (kW)	TC (kW)	PI (kW)	TC (kW)	PI (kW)	TC (kW)	PI (kW)
40		83.8	83.8	29.4	75.4	24.2	67.0	19.5	58.6	15.3	50.3	11.7	41.9	8.62	33.5	6.06	25.1	4.03
39		85.1	85.1	28.9	76.6	23.8	68.1	19.2	59.6	15.1	51.1	11.5	42.5	8.49	34.0	5.97	25.5	3.97
37		87.6	87.6	28.1	78.9	23.1	70.1	18.6	61.3	14.6	52.6	11.2	43.8	8.24	35.1	5.79	26.3	3.85
35		90.0	90.0	27.2	81.0	22.4	72.0	18.0	63.0	14.2	54.0	10.8	45.0	7.98	36.0	5.61	27.0	3.73
33		90.0	90.0	25.2	81.0	20.7	72.0	16.7	63.0	13.2	54.0	10.1	45.0	7.42	36.0	5.23	27.0	3.50
31		90.0	90.0	23.3	81.0	19.2	72.0	15.5	63.0	12.2	54.0	9.37	45.0	6.92	36.0	4.90	27.0	3.29
30		90.0	90.0	22.5	81.0	18.5	72.0	15.0	63.0	11.8	54.0	9.05	45.0	6.69	36.0	4.74	27.0	3.19
29		90.0	90.0	21.7	81.0	17.9	72.0	14.5	63.0	11.4	54.0	8.74	45.0	6.47	36.0	4.59	27.0	3.09
27		90.0	90.0	20.3	81.0	16.7	72.0	13.5	63.0	10.6	54.0	8.17	45.0	6.06	36.0	4.30	27.0	2.91
25		90.0	90.0	18.9	81.0	15.6	72.0	12.6	63.0	9.96	54.0	7.65	45.0	5.68	36.0	4.04	27.0	2.74
23		90.0	90.0	18.1	81.0	14.9	72.0	12.0	63.0	9.52	54.0	7.32	45.0	5.44	36.0	3.88	27.0	2.64
21		90.0	90.0	17.7	81.0	14.6	72.0	11.8	63.0	9.33	54.0	7.18	45.0	5.34	36.0	3.81	27.0	2.60
20		90.0	90.0	17.5	81.0	14.4	72.0	11.7	63.0	9.24	54.0	7.11	45.0	5.29	36.0	3.79	27.0	2.59
19		90.0	90.0	17.3	81.0	14.3	72.0	11.6	63.0	9.16	54.0	7.05	45.0	5.25	36.0	3.76	27.0	2.57
17		90.0	90.0	17.0	81.0	14.1	72.0	11.4	63.0	9.02	54.0	6.95	45.0	5.18	36.0	3.71	27.0	2.54
15		90.0	90.0	16.8	81.0	13.9	72.0	11.2	63.0	8.90	54.0	6.86	45.0	5.11	36.0	3.67	27.0	2.52

TC : Total Capacity PI : Power Input
 Indoor air temperature conditions : 27.0 °C dry-bulb / 19.0 °C wet-bulb

Heating			Compressor + Outdoor Fan Power consumption (kW)															
Outdoor Unit		Outdoor Unit 100% Cooling Capacity (kW)	100%		90%		80%		70%		60%		50%		40%		30%	
Dry-Bulb (°C)	Wet-Bulb (°C)		TC (kW)	PI (kW)	TC (kW)	PI (kW)	TC (kW)	PI (kW)	TC (kW)	PI (kW)	TC (kW)	PI (kW)	TC (kW)	PI (kW)	TC (kW)	PI (kW)	TC (kW)	PI (kW)
15.0	13.7	100.0	100.0	21.0	90.0	17.7	80.0	14.7	70.0	12.2	60.0	9.92	50.0	8.03	40.0	6.48	30.0	5.28
13.0	11.8	100.0	100.0	21.8	90.0	18.4	80.0	15.3	70.0	12.6	60.0	10.2	50.0	8.23	40.0	6.61	30.0	5.35
11.0	9.8	100.0	100.0	22.8	90.0	19.2	80.0	15.9	70.0	13.1	60.0	10.6	50.0	8.47	40.0	6.76	30.0	5.43
9.0	7.9	100.0	100.0	23.9	90.0	20.0	80.0	16.6	70.0	13.6	60.0	10.9	50.0	8.72	40.0	6.91	30.0	5.51
7.0	6.0	100.0	100.0	25.0	90.0	20.9	80.0	17.3	70.0	14.1	60.0	11.3	50.0	8.99	40.0	7.08	30.0	5.60
5.0	4.1	96.4	96.4	24.8	86.8	20.8	77.1	17.2	67.5	14.0	57.9	11.2	48.2	8.93	38.6	7.03	28.9	5.56
3.0	2.2	92.8	92.8	24.6	83.6	20.6	74.3	17.0	65.0	13.9	55.7	11.2	46.4	8.86	37.1	6.97	27.9	5.51
0.0	-0.7	87.4	87.4	24.3	78.6	20.4	69.9	16.8	61.2	13.7	52.4	11.0	43.7	8.75	34.9	6.89	26.2	5.45
-3.0	-3.7	81.7	81.7	24.0	73.5	20.1	65.4	16.6	57.2	13.6	49.0	10.9	40.9	8.65	32.7	6.81	24.5	5.38
-5.0	-5.6	78.1	78.1	23.8	70.3	20.0	62.5	16.5	54.7	13.5	46.9	10.8	39.1	8.58	31.3	6.75	23.4	5.34
-7.0	-7.6	74.4	74.4	23.6	66.9	19.8	59.5	16.4	52.1	13.3	44.6	10.7	37.2	8.50	29.7	6.70	22.3	5.29
-10	-10.5	68.9	68.9	23.3	62.0	19.6	55.1	16.2	48.2	13.2	41.3	10.6	34.5	8.40	27.6	6.61	20.7	5.23
-14.5	-15.0	60.4	60.4	22.9	54.4	19.2	48.3	15.9	42.3	12.9	36.3	10.4	30.2	8.24	24.2	6.49	18.1	5.13

TC : Total Capacity PI : Power Input
 Indoor air temperature conditions : 20.0 °C dry-bulb



MMY-AP3416HT7P (34HP, 95.4kW system)

Cooling			Compressor + Outdoor Fan Power consumption (kW)															
Outdoor Unit Dry-Bulb (°C)		Outdoor Unit 100% Cooling Capacity (kW)	100%		90%		80%		70%		60%		50%		40%		30%	
			TC (kW)	PI (kW)	TC (kW)	PI (kW)	TC (kW)	PI (kW)	TC (kW)	PI (kW)	TC (kW)	PI (kW)	TC (kW)	PI (kW)	TC (kW)	PI (kW)	TC (kW)	PI (kW)
40		88.8	88.8	29.8	79.9	24.7	71.0	20.1	62.1	16.0	53.3	12.4	44.4	9.26	35.5	6.63	26.6	4.49
39		90.2	90.2	29.4	81.2	24.3	72.2	19.8	63.1	15.8	54.1	12.2	45.1	9.12	36.1	6.53	27.1	4.43
37		92.9	92.9	28.5	83.6	23.6	74.3	19.2	65.0	15.3	55.7	11.8	46.4	8.85	37.2	6.33	27.9	4.29
35		95.4	95.4	27.6	85.9	22.9	76.3	18.6	66.8	14.8	57.2	11.5	47.7	8.57	38.2	6.13	28.6	4.16
33		95.4	95.4	25.6	85.9	21.2	76.3	17.3	66.8	13.8	57.2	10.7	47.7	7.99	38.2	5.73	28.6	3.90
31		95.4	95.4	23.8	85.9	19.7	76.3	16.1	66.8	12.8	57.2	9.95	47.7	7.46	38.2	5.37	28.6	3.67
30		95.4	95.4	22.9	85.9	19.0	76.3	15.5	66.8	12.4	57.2	9.61	47.7	7.22	38.2	5.20	28.6	3.56
29		95.4	95.4	22.1	85.9	18.4	76.3	15.0	66.8	12.0	57.2	9.30	47.7	6.99	38.2	5.04	28.6	3.45
27		95.4	95.4	20.7	85.9	17.2	76.3	14.0	66.8	11.2	57.2	8.70	47.7	6.55	38.2	4.73	28.6	3.26
25		95.4	95.4	19.3	85.9	16.1	76.3	13.1	66.8	10.5	57.2	8.15	47.7	6.15	38.2	4.45	28.6	3.07
23		95.4	95.4	18.5	85.9	15.4	76.3	12.5	66.8	10.0	57.2	7.81	47.7	5.90	38.2	4.28	28.6	2.96
21		95.4	95.4	18.1	85.9	15.0	76.3	12.3	66.8	9.84	57.2	7.67	47.7	5.79	38.2	4.21	28.6	2.91
20		95.4	95.4	17.9	85.9	14.9	76.3	12.2	66.8	9.75	57.2	7.60	47.7	5.75	38.2	4.18	28.6	2.90
19		95.4	95.4	17.8	85.9	14.8	76.3	12.1	66.8	9.67	57.2	7.54	47.7	5.70	38.2	4.15	28.6	2.88
17		95.4	95.4	17.5	85.9	14.5	76.3	11.9	66.8	9.52	57.2	7.44	47.7	5.63	38.2	4.10	28.6	2.85
15		95.4	95.4	17.2	85.9	14.3	76.3	11.7	66.8	9.40	57.2	7.34	47.7	5.56	38.2	4.05	28.6	2.82

TC : Total Capacity PI : Power Input
 Indoor air temperature conditions : 27.0 °C dry-bulb / 19.0 °C wet-bulb

Heating			Compressor + Outdoor Fan Power consumption (kW)															
Outdoor Unit Dry-Bulb (°C) / Wet-Bulb (°C)		Outdoor Unit 100% Cooling Capacity (kW)	100%		90%		80%		70%		60%		50%		40%		30%	
			TC (kW)	PI (kW)	TC (kW)	PI (kW)	TC (kW)	PI (kW)	TC (kW)	PI (kW)	TC (kW)	PI (kW)	TC (kW)	PI (kW)	TC (kW)	PI (kW)	TC (kW)	PI (kW)
15.0	13.7	106.0	106.0	22.1	95.4	18.8	84.8	15.8	74.2	13.1	63.6	10.7	53.0	8.64	42.4	6.85	31.8	5.36
13.0	11.8	106.0	106.0	23.0	95.4	19.5	84.8	16.4	74.2	13.6	63.6	11.1	53.0	8.88	42.4	7.01	31.8	5.45
11.0	9.8	106.0	106.0	24.0	95.4	20.3	84.8	17.0	74.2	14.1	63.6	11.4	53.0	9.15	42.4	7.18	31.8	5.55
9.0	7.9	106.0	106.0	25.0	95.4	21.2	84.8	17.7	74.2	14.6	63.6	11.8	53.0	9.43	42.4	7.37	31.8	5.66
7.0	6.0	106.0	106.0	26.1	95.4	22.1	84.8	18.4	74.2	15.2	63.6	12.3	53.0	9.73	42.4	7.57	31.8	5.78
5.0	4.1	102.4	102.4	25.9	92.2	21.9	81.9	18.3	71.7	15.1	61.4	12.2	51.2	9.66	41.0	7.52	30.7	5.74
3.0	2.2	98.8	98.8	25.7	88.9	21.8	79.1	18.2	69.2	15.0	59.3	12.1	49.4	9.60	39.5	7.47	29.6	5.70
0.0	-0.7	93.3	93.3	25.5	84.0	21.6	74.7	18.0	65.3	14.8	56.0	12.0	46.7	9.50	37.3	7.39	28.0	5.65
-3.0	-3.7	87.7	87.7	25.2	78.9	21.3	70.1	17.8	61.4	14.6	52.6	11.8	43.8	9.40	35.1	7.31	26.3	5.59
-5.0	-5.6	84.1	84.1	25.0	75.7	21.2	67.3	17.7	58.9	14.5	50.4	11.8	42.0	9.33	33.6	7.26	25.2	5.55
-7.0	-7.6	80.3	80.3	24.9	72.3	21.0	64.2	17.6	56.2	14.4	48.2	11.7	40.1	9.27	32.1	7.21	24.1	5.51
-10	-10.5	74.8	74.8	24.6	67.3	20.8	59.8	17.4	52.4	14.3	44.9	11.6	37.4	9.17	29.9	7.13	22.4	5.45
-14.5	-15.0	66.3	66.3	24.2	59.7	20.5	53.0	17.1	46.4	14.1	39.8	11.4	33.2	9.02	26.5	7.02	19.9	5.36

TC : Total Capacity PI : Power Input
 Indoor air temperature conditions : 20.0 °C dry-bulb



MMY-AP3616HT7P (36HP, 101kW system)

Cooling			Compressor + Outdoor Fan Power consumption (kW)															
Outdoor Unit		Outdoor Unit 100% Cooling Capacity (kW)	100%		90%		80%		70%		60%		50%		40%		30%	
Dry-Bulb (°C)	TC		PI	TC	PI	TC	PI	TC	PI	TC	PI	TC	PI	TC	PI	TC	PI	
	(kW)		(kW)	(kW)	(kW)	(kW)	(kW)	(kW)	(kW)	(kW)	(kW)	(kW)	(kW)	(kW)	(kW)	(kW)	(kW)	(kW)
40		94.0	94.0	33.9	84.6	27.8	75.2	22.3	65.8	17.4	56.4	13.2	47.0	9.71	37.6	6.84	28.2	4.64
39		95.5	95.5	33.4	85.9	27.3	76.4	21.9	66.8	17.2	57.3	13.0	47.7	9.56	38.2	6.74	28.6	4.57
37		98.3	98.3	32.4	88.5	26.5	78.7	21.3	68.8	16.6	59.0	12.6	49.2	9.27	39.3	6.54	29.5	4.43
35		101.0	101.0	31.5	90.9	25.7	80.8	20.6	70.7	16.1	60.6	12.2	50.5	8.98	40.4	6.33	30.3	4.29
33		101.0	101.0	29.0	90.9	23.8	80.8	19.1	70.7	14.9	60.6	11.4	50.5	8.36	40.4	5.91	30.3	4.03
31		101.0	101.0	26.9	90.9	22.0	80.8	17.7	70.7	13.9	60.6	10.57	50.5	7.79	40.4	5.53	30.3	3.80
30		101.0	101.0	25.9	90.9	21.2	80.8	17.1	70.7	13.4	60.6	10.21	50.5	7.53	40.4	5.36	30.3	3.69
29		101.0	101.0	25.0	90.9	20.5	80.8	16.5	70.7	12.9	60.6	9.86	50.5	7.28	40.4	5.19	30.3	3.58
27		101.0	101.0	23.3	90.9	19.1	80.8	15.4	70.7	12.1	60.6	9.21	50.5	6.82	40.4	4.87	30.3	3.38
25		101.0	101.0	21.7	90.9	17.8	80.8	14.3	70.7	11.3	60.6	8.62	50.5	6.39	40.4	4.58	30.3	3.19
23		101.0	101.0	20.7	90.9	17.0	80.8	13.7	70.7	10.8	60.6	8.25	50.5	6.13	40.4	4.40	30.3	3.07
21		101.0	101.0	20.3	90.9	16.6	80.8	13.4	70.7	10.55	60.6	8.09	50.5	6.01	40.4	4.33	30.3	3.03
20		101.0	101.0	20.1	90.9	16.5	80.8	13.3	70.7	10.45	60.6	8.01	50.5	5.96	40.4	4.30	30.3	3.02
19		101.0	101.0	19.9	90.9	16.3	80.8	13.1	70.7	10.36	60.6	7.95	50.5	5.92	40.4	4.27	30.3	3.00
17		101.0	101.0	19.5	90.9	16.0	80.8	12.9	70.7	10.19	60.6	7.83	50.5	5.83	40.4	4.21	30.3	2.97
15		101.0	101.0	19.2	90.9	15.8	80.8	12.7	70.7	10.05	60.6	7.72	50.5	5.76	40.4	4.17	30.3	2.95

TC : Total Capacity PI : Power Input
Indoor air temperature conditions : 27.0 °C dry-bulb / 19.0 °C wet-bulb

Heating			Compressor + Outdoor Fan Power consumption (kW)															
Outdoor Unit		Outdoor Unit 100% Cooling Capacity (kW)	100%		90%		80%		70%		60%		50%		40%		30%	
Dry-Bulb (°C)	Wet-Bulb (°C)		TC	PI	TC	PI	TC	PI	TC	PI	TC	PI	TC	PI	TC	PI	TC	PI
			(kW)	(kW)	(kW)	(kW)	(kW)	(kW)	(kW)	(kW)	(kW)	(kW)	(kW)	(kW)	(kW)	(kW)	(kW)	(kW)
15.0	13.7	113.0	113.0	24.6	101.7	20.9	90.4	17.6	79.1	14.6	67.8	11.9	56.5	9.50	45.2	7.44	33.9	5.71
13.0	11.8	113.0	113.0	25.6	101.7	21.7	90.4	18.2	79.1	15.1	67.8	12.3	56.5	9.77	45.2	7.62	33.9	5.82
11.0	9.8	113.0	113.0	26.7	101.7	22.6	90.4	19.0	79.1	15.6	67.8	12.7	56.5	10.08	45.2	7.83	33.9	5.94
9.0	7.9	113.0	113.0	27.8	101.7	23.5	90.4	19.7	79.1	16.2	67.8	13.1	56.5	10.39	45.2	8.04	33.9	6.07
7.0	6.0	113.0	113.0	29.0	101.7	24.5	90.4	20.5	79.1	16.8	67.8	13.6	56.5	10.74	45.2	8.27	33.9	6.21
5.0	4.1	109.0	109.0	28.8	98.1	24.4	87.2	20.3	76.3	16.7	65.4	13.5	54.5	10.65	43.6	8.21	32.7	6.16
3.0	2.2	104.9	104.9	28.6	94.4	24.2	83.9	20.2	73.4	16.6	62.9	13.4	52.5	10.57	42.0	8.15	31.5	6.12
0.0	-0.7	98.7	98.7	28.2	88.9	23.9	79.0	20.0	69.1	16.4	59.2	13.2	49.4	10.45	39.5	8.05	29.6	6.04
-3.0	-3.7	92.3	92.3	27.9	83.1	23.6	73.9	19.7	64.6	16.2	55.4	13.1	46.2	10.32	36.9	7.95	27.7	5.97
-5.0	-5.6	88.3	88.3	27.6	79.5	23.4	70.6	19.5	61.8	16.1	53.0	13.0	44.1	10.24	35.3	7.89	26.5	5.92
-7.0	-7.6	84.0	84.0	27.4	75.6	23.2	67.2	19.4	58.8	15.9	50.4	12.9	42.0	10.15	33.6	7.82	25.2	5.87
-10	-10.5	77.9	77.9	27.1	70.1	22.9	62.3	19.1	54.5	15.7	46.7	12.7	38.9	10.03	31.1	7.73	23.4	5.80
-14.5	-15.0	68.3	68.3	26.6	61.4	22.5	54.6	18.8	47.8	15.4	41.0	12.5	34.1	9.83	27.3	7.58	20.5	5.69

TC : Total Capacity PI : Power Input
Indoor air temperature conditions : 20.0 °C dry-bulb



MMY-AP3816HT7P (38HP, 106.5kW system)

Cooling			Compressor + Outdoor Fan Power consumption (kW)															
Outdoor Unit Dry-Bulb (°C)		Outdoor Unit 100% Cooling Capacity (kW)	100%		90%		80%		70%		60%		50%		40%		30%	
			TC (kW)	PI (kW)	TC (kW)	PI (kW)	TC (kW)	PI (kW)	TC (kW)	PI (kW)	TC (kW)	PI (kW)	TC (kW)	PI (kW)	TC (kW)	PI (kW)	TC (kW)	PI (kW)
40		99.1	99.1	37.4	89.2	30.6	79.3	24.5	69.4	19.1	59.5	14.5	49.6	10.5	39.6	7.34	29.7	4.88
39		100.7	100.7	36.8	90.6	30.1	80.6	24.1	70.5	18.8	60.4	14.2	50.3	10.4	40.3	7.23	30.2	4.80
37		103.7	103.7	35.7	93.3	29.2	83.0	23.4	72.6	18.2	62.2	13.8	51.9	10.1	41.5	7.01	31.1	4.66
35		106.5	106.5	34.6	95.9	28.3	85.2	22.6	74.6	17.7	63.9	13.4	53.3	9.75	42.6	6.79	32.0	4.51
33		106.5	106.5	32.0	95.9	26.1	85.2	20.9	74.6	16.4	63.9	12.4	53.3	9.06	42.6	6.33	32.0	4.23
31		106.5	106.5	29.6	95.9	24.2	85.2	19.4	74.6	15.2	63.9	11.53	53.3	8.44	42.6	5.92	32.0	3.98
30		106.5	106.5	28.6	95.9	23.4	85.2	18.7	74.6	14.7	63.9	11.13	53.3	8.15	42.6	5.73	32.0	3.86
29		106.5	106.5	27.5	95.9	22.5	85.2	18.1	74.6	14.1	63.9	10.75	53.3	7.88	42.6	5.55	32.0	3.74
27		106.5	106.5	25.6	95.9	21.0	85.2	16.9	74.6	13.2	63.9	10.04	53.3	7.37	42.6	5.20	32.0	3.53
25		106.5	106.5	23.9	95.9	19.6	85.2	15.7	74.6	12.3	63.9	9.39	53.3	6.91	42.6	4.88	32.0	3.32
23		106.5	106.5	22.8	95.9	18.7	85.2	15.0	74.6	11.8	63.9	8.98	53.3	6.61	42.6	4.69	32.0	3.20
21		106.5	106.5	22.3	95.9	18.3	85.2	14.7	74.6	11.53	63.9	8.80	53.3	6.49	42.6	4.61	32.0	3.16
20		106.5	106.5	22.1	95.9	18.1	85.2	14.6	74.6	11.42	63.9	8.71	53.3	6.43	42.6	4.57	32.0	3.14
19		106.5	106.5	21.9	95.9	17.9	85.2	14.4	74.6	11.32	63.9	8.64	53.3	6.38	42.6	4.54	32.0	3.12
17		106.5	106.5	21.5	95.9	17.6	85.2	14.2	74.6	11.14	63.9	8.51	53.3	6.29	42.6	4.48	32.0	3.09
15		106.5	106.5	21.2	95.9	17.4	85.2	14.0	74.6	10.98	63.9	8.39	53.3	6.21	42.6	4.43	32.0	3.06

TC : Total Capacity PI : Power Input
 Indoor air temperature conditions : 27.0 °C dry-bulb / 19.0 °C wet-bulb

Heating			Compressor + Outdoor Fan Power consumption (kW)															
Outdoor Unit		Outdoor Unit 100% Cooling Capacity (kW)	100%		90%		80%		70%		60%		50%		40%		30%	
Dry-Bulb (°C)	Wet-Bulb (°C)		TC (kW)	PI (kW)	TC (kW)	PI (kW)	TC (kW)	PI (kW)	TC (kW)	PI (kW)	TC (kW)	PI (kW)	TC (kW)	PI (kW)	TC (kW)	PI (kW)	TC (kW)	PI (kW)
15.0	13.7	114.0	114.0	24.7	102.6	21.0	91.2	17.7	79.8	14.7	68.4	12.0	57.0	9.57	45.6	7.51	34.2	5.77
13.0	11.8	114.0	114.0	25.7	102.6	21.8	91.2	18.3	79.8	15.2	68.4	12.3	57.0	9.84	45.6	7.69	34.2	5.88
11.0	9.8	114.0	114.0	26.7	102.6	22.7	91.2	19.0	79.8	15.7	68.4	12.8	57.0	10.1	45.6	7.90	34.2	6.01
9.0	7.9	114.0	114.0	27.9	102.6	23.6	91.2	19.8	79.8	16.3	68.4	13.2	57.0	10.5	45.6	8.11	34.2	6.14
7.0	6.0	114.0	114.0	29.1	102.6	24.6	91.2	20.6	79.8	16.9	68.4	13.7	57.0	10.8	45.6	8.34	34.2	6.28
5.0	4.1	109.9	109.9	28.9	98.9	24.5	87.9	20.4	76.9	16.8	65.9	13.6	55.0	10.7	44.0	8.28	33.0	6.23
3.0	2.2	105.8	105.8	28.7	95.2	24.3	84.7	20.3	74.1	16.7	63.5	13.5	52.9	10.6	42.3	8.22	31.7	6.18
0.0	-0.7	99.6	99.6	28.3	89.6	24.0	79.7	20.0	69.7	16.5	59.8	13.3	49.8	10.5	39.8	8.12	29.9	6.11
-3.0	-3.7	93.2	93.2	28.0	83.8	23.7	74.5	19.8	65.2	16.3	55.9	13.1	46.6	10.4	37.3	8.02	27.9	6.03
-5.0	-5.6	89.1	89.1	27.7	80.2	23.5	71.3	19.6	62.4	16.1	53.4	13.0	44.5	10.3	35.6	7.96	26.7	5.99
-7.0	-7.6	84.8	84.8	27.5	76.3	23.3	67.8	19.5	59.3	16.0	50.9	12.9	42.4	10.2	33.9	7.89	25.4	5.94
-10	-10.5	78.5	78.5	27.2	70.7	23.0	62.8	19.2	55.0	15.8	47.1	12.8	39.3	10.1	31.4	7.79	23.6	5.86
-14.5	-15.0	68.9	68.9	26.6	62.0	22.6	55.1	18.9	48.2	15.5	41.3	12.5	34.4	9.90	27.6	7.64	20.7	5.75

TC : Total Capacity PI : Power Input
 Indoor air temperature conditions : 20.0 °C dry-bulb



MMY-AP4016HT7P (40HP, 112kW system)

Cooling			Compressor + Outdoor Fan Power consumption (kW)															
Outdoor Unit Dry-Bulb (°C)		Outdoor Unit 100% Cooling Capacity (kW)	100%		90%		80%		70%		60%		50%		40%		30%	
			TC (kW)	PI (kW)	TC (kW)	PI (kW)	TC (kW)	PI (kW)	TC (kW)	PI (kW)	TC (kW)	PI (kW)	TC (kW)	PI (kW)	TC (kW)	PI (kW)	TC (kW)	PI (kW)
40		104.2	104.2	38.5	93.8	31.3	83.4	25.0	73.0	19.5	62.5	14.8	52.1	10.8	41.7	7.62	31.3	5.24
39		105.9	105.9	37.9	95.3	30.9	84.7	24.7	74.1	19.2	63.5	14.5	52.9	10.6	42.4	7.51	31.8	5.16
37		109.1	109.1	36.7	98.2	29.9	87.2	23.9	76.3	18.6	65.4	14.1	54.5	10.3	43.6	7.28	32.7	5.01
35		112.0	112.0	35.8	100.8	29.0	89.6	23.2	78.4	18.0	67.2	13.7	56.0	9.99	44.8	7.05	33.6	4.85
33		112.0	112.0	32.9	100.8	26.8	89.6	21.4	78.4	16.7	67.2	12.7	56.0	9.29	44.8	6.59	33.6	4.57
31		112.0	112.0	30.4	100.8	24.8	89.6	19.9	78.4	15.5	67.2	11.8	56.0	8.66	44.8	6.17	33.6	4.31
30		112.0	112.0	29.3	100.8	23.9	89.6	19.2	78.4	15.0	67.2	11.4	56.0	8.37	44.8	5.98	33.6	4.18
29		112.0	112.0	28.3	100.8	23.1	89.6	18.5	78.4	14.4	67.2	11.0	56.0	8.10	44.8	5.79	33.6	4.07
27		112.0	112.0	26.3	100.8	21.5	89.6	17.2	78.4	13.5	67.2	10.3	56.0	7.58	44.8	5.44	33.6	3.84
25		112.0	112.0	24.5	100.8	20.1	89.6	16.1	78.4	12.6	67.2	9.59	56.0	7.11	44.8	5.12	33.6	3.63
23		112.0	112.0	23.4	100.8	19.1	89.6	15.3	78.4	12.0	67.2	9.18	56.0	6.81	44.8	4.92	33.6	3.51
21		112.0	112.0	22.9	100.8	18.7	89.6	15.0	78.4	11.8	67.2	9.00	56.0	6.69	44.8	4.84	33.6	3.47
20		112.0	112.0	22.6	100.8	18.5	89.6	14.9	78.4	11.7	67.2	8.91	56.0	6.63	44.8	4.81	33.6	3.45
19		112.0	112.0	22.4	100.8	18.3	89.6	14.7	78.4	11.6	67.2	8.84	56.0	6.58	44.8	4.78	33.6	3.43
17		112.0	112.0	22.0	100.8	18.0	89.6	14.5	78.4	11.4	67.2	8.70	56.0	6.49	44.8	4.72	33.6	3.40
15		112.0	112.0	21.7	100.8	17.8	89.6	14.3	78.4	11.2	67.2	8.59	56.0	6.41	44.8	4.67	33.6	3.37

TC : Total Capacity PI : Power Input
 Indoor air temperature conditions : 27.0 °C dry-bulb / 19.0 °C wet-bulb

Heating			Compressor + Outdoor Fan Power consumption (kW)															
Outdoor Unit Dry-Bulb (°C) / Wet-Bulb (°C)		Outdoor Unit 100% Cooling Capacity (kW)	100%		90%		80%		70%		60%		50%		40%		30%	
			TC (kW)	PI (kW)	TC (kW)	PI (kW)	TC (kW)	PI (kW)	TC (kW)	PI (kW)	TC (kW)	PI (kW)	TC (kW)	PI (kW)	TC (kW)	PI (kW)	TC (kW)	PI (kW)
15.0	13.7	126.0	126.0	28.2	113.4	24.2	100.8	20.4	88.2	17.0	75.6	13.8	63.0	11.0	50.4	8.40	37.8	6.13
13.0	11.8	126.0	126.0	29.3	113.4	25.1	100.8	21.2	88.2	17.6	75.6	14.3	63.0	11.3	50.4	8.64	37.8	6.29
11.0	9.8	126.0	126.0	30.5	113.4	26.1	100.8	22.0	88.2	18.2	75.6	14.8	63.0	11.7	50.4	8.91	37.8	6.46
9.0	7.9	126.0	126.0	31.7	113.4	27.1	100.8	22.8	88.2	18.9	75.6	15.3	63.0	12.1	50.4	9.18	37.8	6.63
7.0	6.0	126.0	126.0	33.0	113.4	28.2	100.8	23.7	88.2	19.6	75.6	15.9	63.0	12.5	50.4	9.47	37.8	6.82
5.0	4.1	121.5	121.5	32.7	109.3	27.9	97.2	23.5	85.0	19.4	72.9	15.7	60.7	12.4	48.6	9.40	36.4	6.77
3.0	2.2	117.0	117.0	32.5	105.3	27.7	93.6	23.3	81.9	19.3	70.2	15.6	58.5	12.3	46.8	9.32	35.1	6.72
0.0	-0.7	110.1	110.1	32.1	99.1	27.4	88.1	23.1	77.1	19.1	66.1	15.4	55.0	12.1	44.0	9.21	33.0	6.64
-3.0	-3.7	103.0	103.0	31.7	92.7	27.1	82.4	22.8	72.1	18.8	61.8	15.2	51.5	12.0	41.2	9.10	30.9	6.56
-5.0	-5.6	98.5	98.5	31.5	88.6	26.9	78.8	22.6	68.9	18.7	59.1	15.1	49.2	11.9	39.4	9.03	29.5	6.51
-7.0	-7.6	93.7	93.7	31.2	84.3	26.6	75.0	22.4	65.6	18.5	56.2	15.0	46.9	11.8	37.5	8.95	28.1	6.45
-10	-10.5	86.8	86.8	30.8	78.1	26.3	69.5	22.1	60.8	18.3	52.1	14.8	43.4	11.7	34.7	8.84	26.0	6.37
-14.5	-15.0	76.1	76.1	30.2	68.5	25.8	60.9	21.7	53.3	17.9	45.7	14.5	38.1	11.4	30.5	8.67	22.8	6.25

TC : Total Capacity PI : Power Input
 Indoor air temperature conditions : 20.0 °C dry-bulb



MMY-AP4216HT7P (42HP, 117.5kW system)

Cooling			Compressor + Outdoor Fan Power consumption (kW)															
Outdoor Unit Dry-Bulb (°C)		Outdoor Unit 100% Cooling Capacity (kW)	100%		90%		80%		70%		60%		50%		40%		30%	
			TC (kW)	PI (kW)	TC (kW)	PI (kW)	TC (kW)	PI (kW)	TC (kW)	PI (kW)	TC (kW)	PI (kW)	TC (kW)	PI (kW)	TC (kW)	PI (kW)	TC (kW)	PI (kW)
40		109.3	109.3	41.9	98.4	34.1	87.5	27.2	76.5	21.2	65.6	16.0	54.7	11.6	43.7	8.12	32.8	5.48
39		111.1	111.1	41.3	100.0	33.6	88.9	26.8	77.8	20.9	66.7	15.7	55.5	11.4	44.4	8.00	33.3	5.40
37		114.4	114.4	40.0	103.0	32.6	91.5	26.0	80.1	20.2	68.7	15.3	57.2	11.1	45.8	7.76	34.3	5.23
35		117.5	117.5	38.9	105.8	31.6	94.0	25.2	82.3	19.6	70.5	14.8	58.8	10.8	47.0	7.52	35.3	5.07
33		117.5	117.5	35.8	105.8	29.2	94.0	23.3	82.3	18.1	70.5	13.7	58.8	9.99	47.0	7.01	35.3	4.76
31		117.5	117.5	33.2	105.8	27.1	94.0	21.6	82.3	16.8	70.5	12.7	58.8	9.31	47.0	6.56	35.3	4.49
30		117.5	117.5	32.0	105.8	26.1	94.0	20.8	82.3	16.2	70.5	12.3	58.8	9.00	47.0	6.35	35.3	4.36
29		117.5	117.5	30.8	105.8	25.1	94.0	20.1	82.3	15.7	70.5	11.9	58.8	8.70	47.0	6.15	35.3	4.23
27		117.5	117.5	28.7	105.8	23.4	94.0	18.7	82.3	14.6	70.5	11.1	58.8	8.14	47.0	5.77	35.3	3.99
25		117.5	117.5	26.7	105.8	21.8	94.0	17.5	82.3	13.6	70.5	10.4	58.8	7.62	47.0	5.42	35.3	3.77
23		117.5	117.5	25.5	105.8	20.8	94.0	16.7	82.3	13.0	70.5	9.91	58.8	7.30	47.0	5.21	35.3	3.64
21		117.5	117.5	24.9	105.8	20.4	94.0	16.3	82.3	12.75	70.5	9.71	58.8	7.16	47.0	5.12	35.3	3.59
20		117.5	117.5	24.7	105.8	20.2	94.0	16.1	82.3	12.63	70.5	9.62	58.8	7.10	47.0	5.09	35.3	3.57
19		117.5	117.5	24.4	105.8	20.0	94.0	16.0	82.3	12.51	70.5	9.53	58.8	7.04	47.0	5.05	35.3	3.55
17		117.5	117.5	24.0	105.8	19.6	94.0	15.7	82.3	12.31	70.5	9.38	58.8	6.94	47.0	4.99	35.3	3.52
15		117.5	117.5	23.6	105.8	19.3	94.0	15.5	82.3	12.14	70.5	9.26	58.8	6.86	47.0	4.93	35.3	3.49

TC : Total Capacity PI : Power Input
Indoor air temperature conditions : 27.0 °C dry-bulb / 19.0 °C wet-bulb

Heating			Compressor + Outdoor Fan Power consumption (kW)															
Outdoor Unit Dry-Bulb (°C) / Wet-Bulb (°C)		Outdoor Unit 100% Cooling Capacity (kW)	100%		90%		80%		70%		60%		50%		40%		30%	
			TC (kW)	PI (kW)	TC (kW)	PI (kW)	TC (kW)	PI (kW)	TC (kW)	PI (kW)	TC (kW)	PI (kW)	TC (kW)	PI (kW)	TC (kW)	PI (kW)	TC (kW)	PI (kW)
15.0	13.7	127.0	127.0	28.3	114.3	24.3	101.6	20.5	88.9	17.1	76.2	13.9	63.5	11.0	50.8	8.47	38.1	6.20
13.0	11.8	127.0	127.0	29.4	114.3	25.2	101.6	21.2	88.9	17.6	76.2	14.4	63.5	11.4	50.8	8.71	38.1	6.35
11.0	9.8	127.0	127.0	30.6	114.3	26.1	101.6	22.1	88.9	18.3	76.2	14.9	63.5	11.8	50.8	8.97	38.1	6.53
9.0	7.9	127.0	127.0	31.8	114.3	27.2	101.6	22.9	88.9	19.0	76.2	15.4	63.5	12.1	50.8	9.25	38.1	6.70
7.0	6.0	127.0	127.0	33.1	114.3	28.3	101.6	23.8	88.9	19.7	76.2	15.9	63.5	12.5	50.8	9.54	38.1	6.89
5.0	4.1	122.4	122.4	32.8	110.2	28.0	98.0	23.6	85.7	19.5	73.5	15.8	61.2	12.5	49.0	9.46	36.7	6.84
3.0	2.2	117.9	117.9	32.6	106.1	27.8	94.3	23.4	82.5	19.4	70.7	15.7	59.0	12.4	47.2	9.39	35.4	6.78
0.0	-0.7	111.0	111.0	32.2	99.9	27.5	88.8	23.1	77.7	19.1	66.6	15.5	55.5	12.2	44.4	9.28	33.3	6.70
-3.0	-3.7	103.8	103.8	31.8	93.4	27.2	83.0	22.9	72.6	18.9	62.3	15.3	51.9	12.1	41.5	9.17	31.1	6.62
-5.0	-5.6	99.2	99.2	31.6	89.3	26.9	79.4	22.7	69.5	18.8	59.5	15.2	49.6	12.0	39.7	9.09	29.8	6.57
-7.0	-7.6	94.4	94.4	31.3	85.0	26.7	75.6	22.5	66.1	18.6	56.7	15.1	47.2	11.9	37.8	9.02	28.3	6.51
-10	-10.5	87.5	87.5	30.9	78.8	26.4	70.0	22.2	61.3	18.4	52.5	14.9	43.8	11.7	35.0	8.91	26.3	6.43
-14.5	-15.0	76.7	76.7	30.3	69.1	25.9	61.4	21.8	53.7	18.0	46.0	14.6	38.4	11.5	30.7	8.74	23.0	6.31

TC : Total Capacity PI : Power Input
Indoor air temperature conditions : 20.0 °C dry-bulb



MMY-AP4416HT7P (44HP, 123kW system)

Cooling			Compressor + Outdoor Fan Power consumption (kW)														
Outdoor Unit Dry-Bulb (°C)	Outdoor Unit 100% Cooling Capacity (kW)	100%		90%		80%		70%		60%		50%		40%		30%	
		TC (kW)	PI (kW)	TC (kW)	PI (kW)	TC (kW)	PI (kW)	TC (kW)	PI (kW)	TC (kW)	PI (kW)	TC (kW)	PI (kW)	TC (kW)	PI (kW)	TC (kW)	PI (kW)
40	114.5	114.5	45.4	103.0	36.9	91.6	29.4	80.1	22.9	68.7	17.2	57.2	12.4	45.8	8.62	34.3	5.72
39	116.3	116.3	44.7	104.7	36.4	93.0	29.0	81.4	22.5	69.8	16.9	58.2	12.3	46.5	8.49	34.9	5.63
37	119.8	119.8	43.3	107.8	35.3	95.8	28.1	83.8	21.8	71.9	16.4	59.9	11.9	47.9	8.24	35.9	5.46
35	123.0	123.0	42.0	110.7	34.2	98.4	27.2	86.1	21.2	73.8	15.9	61.5	11.5	49.2	7.98	36.9	5.29
33	123.0	123.0	38.8	110.7	31.6	98.4	25.2	86.1	19.6	73.8	14.7	61.5	10.7	49.2	7.44	36.9	4.96
31	123.0	123.0	35.9	110.7	29.3	98.4	23.3	86.1	18.2	73.8	13.7	61.5	9.96	49.2	6.95	36.9	4.67
30	123.0	123.0	34.6	110.7	28.2	98.4	22.5	86.1	17.5	73.8	13.2	61.5	9.62	49.2	6.72	36.9	4.53
29	123.0	123.0	33.3	110.7	27.2	98.4	21.7	86.1	16.9	73.8	12.8	61.5	9.29	49.2	6.51	36.9	4.40
27	123.0	123.0	31.0	110.7	25.3	98.4	20.2	86.1	15.7	73.8	11.9	61.5	8.69	49.2	6.10	36.9	4.14
25	123.0	123.0	28.9	110.7	23.6	98.4	18.9	86.1	14.7	73.8	11.1	61.5	8.13	49.2	5.73	36.9	3.91
23	123.0	123.0	27.6	110.7	22.5	98.4	18.0	86.1	14.0	73.8	10.6	61.5	7.79	49.2	5.50	36.9	3.76
21	123.0	123.0	27.0	110.7	22.0	98.4	17.6	86.1	13.7	73.8	10.4	61.5	7.64	49.2	5.40	36.9	3.71
20	123.0	123.0	26.7	110.7	21.8	98.4	17.4	86.1	13.6	73.8	10.3	61.5	7.57	49.2	5.36	36.9	3.69
19	123.0	123.0	26.4	110.7	21.6	98.4	17.3	86.1	13.5	73.8	10.2	61.5	7.51	49.2	5.32	36.9	3.67
17	123.0	123.0	26.0	110.7	21.2	98.4	17.0	86.1	13.3	73.8	10.1	61.5	7.40	49.2	5.25	36.9	3.63
15	123.0	123.0	25.6	110.7	20.9	98.4	16.7	86.1	13.1	73.8	9.93	61.5	7.30	49.2	5.19	36.9	3.60

TC : Total Capacity PI : Power Input
 Indoor air temperature conditions : 27.0 °C dry-bulb / 19.0 °C wet-bulb

Heating			Compressor + Outdoor Fan Power consumption (kW)															
Outdoor Unit Dry-Bulb (°C)	Outdoor Unit Wet-Bulb (°C)	Outdoor Unit 100% Cooling Capacity (kW)	100%		90%		80%		70%		60%		50%		40%		30%	
			TC (kW)	PI (kW)	TC (kW)	PI (kW)	TC (kW)	PI (kW)	TC (kW)	PI (kW)	TC (kW)	PI (kW)	TC (kW)	PI (kW)	TC (kW)	PI (kW)	TC (kW)	PI (kW)
15.0	13.7	128.0	128.0	28.4	115.2	24.4	102.4	20.6	89.6	17.1	76.8	14.0	64.0	11.1	51.2	8.54	38.4	6.27
13.0	11.8	128.0	128.0	29.5	115.2	25.2	102.4	21.3	89.6	17.7	76.8	14.4	64.0	11.4	51.2	8.78	38.4	6.42
11.0	9.8	128.0	128.0	30.7	115.2	26.2	102.4	22.1	89.6	18.4	76.8	14.9	64.0	11.8	51.2	9.04	38.4	6.59
9.0	7.9	128.0	128.0	31.9	115.2	27.2	102.4	23.0	89.6	19.0	76.8	15.4	64.0	12.2	51.2	9.31	38.4	6.77
7.0	6.0	128.0	128.0	33.2	115.2	28.3	102.4	23.9	89.6	19.8	76.8	16.0	64.0	12.6	51.2	9.61	38.4	6.96
5.0	4.1	123.4	123.4	32.9	111.1	28.1	98.7	23.7	86.4	19.6	74.0	15.9	61.7	12.5	49.4	9.53	37.0	6.90
3.0	2.2	118.8	118.8	32.7	106.9	27.9	95.1	23.5	83.2	19.5	71.3	15.8	59.4	12.4	47.5	9.46	35.6	6.85
0.0	-0.7	111.8	111.8	32.3	100.7	27.6	89.5	23.2	78.3	19.2	67.1	15.6	55.9	12.3	44.7	9.35	33.6	6.77
-3.0	-3.7	104.6	104.6	31.9	94.1	27.2	83.7	22.9	73.2	19.0	62.8	15.4	52.3	12.1	41.8	9.23	31.4	6.69
-5.0	-5.6	100.0	100.0	31.7	90.0	27.0	80.0	22.8	70.0	18.8	60.0	15.3	50.0	12.0	40.0	9.16	30.0	6.63
-7.0	-7.6	95.2	95.2	31.4	85.7	26.8	76.2	22.6	66.6	18.7	57.1	15.1	47.6	11.9	38.1	9.08	28.6	6.58
-10	-10.5	88.2	88.2	31.0	79.4	26.5	70.6	22.3	61.7	18.4	52.9	14.9	44.1	11.8	35.3	8.97	26.5	6.50
-14.5	-15.0	77.3	77.3	30.4	69.6	26.0	61.9	21.9	54.1	18.1	46.4	14.7	38.7	11.6	30.9	8.80	23.2	6.37

TC : Total Capacity PI : Power Input
 Indoor air temperature conditions : 20.0 °C dry-bulb



MMY-AP4616HT7P (46HP, 130kW system)

Cooling			Compressor + Outdoor Fan Power consumption (kW)														
Outdoor Unit Dry-Bulb (°C)	Outdoor Unit 100% Cooling Capacity (kW)	100%		90%		80%		70%		60%		50%		40%		30%	
		TC	PI	TC	PI	TC	PI	TC	PI	TC	PI	TC	PI	TC	PI	TC	PI
		(kW)	(kW)	(kW)	(kW)	(kW)	(kW)	(kW)	(kW)	(kW)	(kW)	(kW)	(kW)	(kW)	(kW)	(kW)	(kW)
40	121.0	121.0	41.8	108.9	34.4	96.8	27.8	84.7	21.9	72.6	16.8	60.5	12.4	48.4	8.78	36.3	5.90
39	122.9	122.9	41.2	110.6	33.9	98.3	27.4	86.0	21.6	73.8	16.5	61.5	12.2	49.2	8.65	36.9	5.82
37	126.6	126.6	39.9	113.9	32.9	101.3	26.6	88.6	20.9	76.0	16.0	63.3	11.9	50.6	8.39	38.0	5.64
35	130.0	130.0	38.7	117.0	31.9	104.0	25.7	91.0	20.3	78.0	15.5	65.0	11.5	52.0	8.13	39.0	5.46
33	130.0	130.0	35.8	117.0	29.5	104.0	23.8	91.0	18.8	78.0	14.4	65.0	10.7	52.0	7.59	39.0	5.13
31	130.0	130.0	33.2	117.0	27.4	104.0	22.2	91.0	17.5	78.0	13.4	65.0	9.98	52.0	7.10	39.0	4.82
30	130.0	130.0	32.1	117.0	26.4	104.0	21.4	91.0	16.9	78.0	13.0	65.0	9.65	52.0	6.88	39.0	4.68
29	130.0	130.0	30.9	117.0	25.5	104.0	20.6	91.0	16.3	78.0	12.6	65.0	9.33	52.0	6.66	39.0	4.54
27	130.0	130.0	28.8	117.0	23.8	104.0	19.3	91.0	15.2	78.0	11.7	65.0	8.74	52.0	6.25	39.0	4.28
25	130.0	130.0	26.9	117.0	22.2	104.0	18.0	91.0	14.3	78.0	11.0	65.0	8.20	52.0	5.88	39.0	4.03
23	130.0	130.0	25.7	117.0	21.2	104.0	17.2	91.0	13.6	78.0	10.5	65.0	7.86	52.0	5.64	39.0	3.88
21	130.0	130.0	25.2	117.0	20.8	104.0	16.9	91.0	13.4	78.0	10.3	65.0	7.71	52.0	5.55	39.0	3.83
20	130.0	130.0	24.9	117.0	20.6	104.0	16.7	91.0	13.2	78.0	10.2	65.0	7.65	52.0	5.51	39.0	3.80
19	130.0	130.0	24.7	117.0	20.4	104.0	16.6	91.0	13.1	78.0	10.1	65.0	7.59	52.0	5.47	39.0	3.78
17	130.0	130.0	24.3	117.0	20.1	104.0	16.3	91.0	12.9	78.0	10.0	65.0	7.48	52.0	5.40	39.0	3.74
15	130.0	130.0	23.9	117.0	19.8	104.0	16.1	91.0	12.8	78.0	9.87	65.0	7.39	52.0	5.34	39.0	3.71

TC : Total Capacity PI : Power Input
 Indoor air temperature conditions : 27.0 °C dry-bulb / 19.0 °C wet-bulb

Heating			Compressor + Outdoor Fan Power consumption (kW)															
Outdoor Unit		Outdoor Unit 100% Cooling Capacity (kW)	100%		90%		80%		70%		60%		50%		40%		30%	
Dry-Bulb (°C)	Wet-Bulb (°C)		TC	PI	TC	PI	TC	PI	TC	PI	TC	PI	TC	PI	TC	PI	TC	PI
(°C)	(°C)		(kW)	(kW)	(kW)	(kW)	(kW)	(kW)	(kW)	(kW)	(kW)	(kW)	(kW)	(kW)	(kW)	(kW)	(kW)	(kW)
15.0	13.7	145.0	145.0	29.9	130.5	25.2	116.0	21.1	101.5	17.4	87.0	14.2	72.5	11.5	58.0	9.33	43.5	7.63
13.0	11.8	145.0	145.0	31.1	130.5	26.2	116.0	21.8	101.5	18.0	87.0	14.6	72.5	11.8	58.0	9.51	43.5	7.73
11.0	9.8	145.0	145.0	32.5	130.5	27.4	116.0	22.7	101.5	18.7	87.0	15.1	72.5	12.2	58.0	9.72	43.5	7.84
9.0	7.9	145.0	145.0	34.0	130.5	28.5	116.0	23.7	101.5	19.4	87.0	15.7	72.5	12.5	58.0	9.94	43.5	7.95
7.0	6.0	145.0	145.0	35.6	130.5	29.8	116.0	24.7	101.5	20.1	87.0	16.2	72.5	12.9	58.0	10.18	43.5	8.08
5.0	4.1	140.0	140.0	35.3	126.0	29.6	112.0	24.5	98.0	20.0	84.0	16.1	70.0	12.8	56.0	10.11	42.0	8.02
3.0	2.2	134.9	134.9	35.1	121.4	29.4	108.0	24.3	94.5	19.9	81.0	16.0	67.5	12.7	54.0	10.04	40.5	7.96
0.0	-0.7	127.3	127.3	34.7	114.5	29.1	101.8	24.1	89.1	19.6	76.4	15.8	63.6	12.6	50.9	9.93	38.2	7.88
-3.0	-3.7	119.3	119.3	34.3	107.4	28.8	95.5	23.8	83.5	19.4	71.6	15.6	59.7	12.4	47.7	9.81	35.8	7.79
-5.0	-5.6	114.3	114.3	34.1	102.9	28.6	91.4	23.6	80.0	19.3	68.6	15.5	57.1	12.3	45.7	9.74	34.3	7.73
-7.0	-7.6	109.0	109.0	33.8	98.1	28.3	87.2	23.4	76.3	19.1	65.4	15.4	54.5	12.2	43.6	9.67	32.7	7.67
-10	-10.5	101.3	101.3	33.4	91.2	28.0	81.1	23.2	70.9	18.9	60.8	15.2	50.7	12.1	40.5	9.56	30.4	7.59
-14.5	-15.0	89.4	89.4	32.8	80.5	27.5	71.5	22.8	62.6	18.6	53.7	15.0	44.7	11.9	35.8	9.39	26.8	7.45

TC : Total Capacity PI : Power Input
 Indoor air temperature conditions : 20.0 °C dry-bulb

MMY-AP4816HT7P (48HP, 135kW system)

Cooling			Compressor + Outdoor Fan Power consumption (kW)														
Outdoor Unit Dry-Bulb (°C)	Outdoor Unit 100% Cooling Capacity (kW)	100%		90%		80%		70%		60%		50%		40%		30%	
		TC	PI	TC	PI	TC	PI	TC	PI	TC	PI	TC	PI	TC	PI	TC	PI
		(kW)	(kW)	(kW)	(kW)	(kW)	(kW)	(kW)	(kW)	(kW)	(kW)	(kW)	(kW)	(kW)	(kW)	(kW)	(kW)
40	125.6	125.6	44.1	113.1	36.3	100.5	29.2	87.9	23.0	75.4	17.6	62.8	12.9	50.3	9.09	37.7	6.05
39	127.6	127.6	43.4	114.9	35.7	102.1	28.8	89.4	22.7	76.6	17.3	63.8	12.7	51.1	8.96	38.3	5.96
37	131.5	131.5	42.1	118.3	34.6	105.2	27.9	92.0	22.0	78.9	16.8	65.7	12.4	52.6	8.69	39.4	5.78
35	135.0	135.0	40.8	121.5	33.6	108.0	27.0	94.5	21.3	81.0	16.3	67.5	12.0	54.0	8.41	40.5	5.60
33	135.0	135.0	37.7	121.5	31.1	108.0	25.1	94.5	19.7	81.0	15.1	67.5	11.1	54.0	7.85	40.5	5.25
31	135.0	135.0	35.0	121.5	28.8	108.0	23.3	94.5	18.4	81.0	14.1	67.5	10.38	54.0	7.34	40.5	4.93
30	135.0	135.0	33.8	121.5	27.8	108.0	22.5	94.5	17.7	81.0	13.6	67.5	10.04	54.0	7.11	40.5	4.78
29	135.0	135.0	32.6	121.5	26.8	108.0	21.7	94.5	17.1	81.0	13.1	67.5	9.71	54.0	6.88	40.5	4.64
27	135.0	135.0	30.4	121.5	25.0	108.0	20.2	94.5	16.0	81.0	12.3	67.5	9.09	54.0	6.46	40.5	4.37
25	135.0	135.0	28.4	121.5	23.4	108.0	18.9	94.5	14.9	81.0	11.5	67.5	8.51	54.0	6.06	40.5	4.12
23	135.0	135.0	27.1	121.5	22.3	108.0	18.1	94.5	14.3	81.0	11.0	67.5	8.16	54.0	5.82	40.5	3.96
21	135.0	135.0	26.5	121.5	21.9	108.0	17.7	94.5	14.0	81.0	10.8	67.5	8.01	54.0	5.72	40.5	3.91
20	135.0	135.0	26.2	121.5	21.6	108.0	17.5	94.5	13.9	81.0	10.7	67.5	7.94	54.0	5.68	40.5	3.88
19	135.0	135.0	26.0	121.5	21.4	108.0	17.4	94.5	13.7	81.0	10.6	67.5	7.88	54.0	5.64	40.5	3.86
17	135.0	135.0	25.6	121.5	21.1	108.0	17.1	94.5	13.5	81.0	10.4	67.5	7.77	54.0	5.56	40.5	3.81
15	135.0	135.0	25.2	121.5	20.8	108.0	16.8	94.5	13.3	81.0	10.28	67.5	7.67	54.0	5.50	40.5	3.78

TC : Total Capacity PI : Power Input
 Indoor air temperature conditions : 27.0 °C dry-bulb / 19.0 °C wet-bulb

Heating			Compressor + Outdoor Fan Power consumption (kW)															
Outdoor Unit		Outdoor Unit 100% Cooling Capacity (kW)	100%		90%		80%		70%		60%		50%		40%		30%	
Dry-Bulb (°C)	Wet-Bulb (°C)		TC	PI	TC	PI	TC	PI	TC	PI	TC	PI	TC	PI	TC	PI	TC	PI
(°C)	(°C)		(kW)	(kW)	(kW)	(kW)	(kW)	(kW)	(kW)	(kW)	(kW)	(kW)	(kW)	(kW)	(kW)	(kW)	(kW)	(kW)
15.0	13.7	150.0	150.0	31.4	135.0	26.5	120.0	22.1	105.0	18.2	90.0	14.9	75.0	12.0	60.0	9.72	45.0	7.92
13.0	11.8	150.0	150.0	32.8	135.0	27.6	120.0	23.0	105.0	18.9	90.0	15.3	75.0	12.4	60.0	9.91	45.0	8.02
11.0	9.8	150.0	150.0	34.3	135.0	28.8	120.0	23.9	105.0	19.6	90.0	15.9	75.0	12.7	60.0	10.1	45.0	8.14
9.0	7.9	150.0	150.0	35.8	135.0	30.0	120.0	24.9	105.0	20.3	90.0	16.4	75.0	13.1	60.0	10.4	45.0	8.26
7.0	6.0	150.0	150.0	37.5	135.0	31.4	120.0	26.0	105.0	21.2	90.0	17.0	75.0	13.5	60.0	10.6	45.0	8.40
5.0	4.1	144.6	144.6	37.2	130.2	31.2	115.7	25.8	101.2	21.0	86.8	16.9	72.3	13.4	57.9	10.5	43.4	8.33
3.0	2.2	139.3	139.3	36.9	125.3	30.9	111.4	25.6	97.5	20.8	83.6	16.7	69.6	13.3	55.7	10.5	41.8	8.27
0.0	-0.7	131.1	131.1	36.5	118.0	30.6	104.8	25.3	91.7	20.6	78.6	16.5	65.5	13.1	52.4	10.3	39.3	8.17
-3.0	-3.7	122.6	122.6	36.0	110.3	30.2	98.1	25.0	85.8	20.3	73.5	16.3	61.3	13.0	49.0	10.2	36.8	8.07
-5.0	-5.6	117.2	117.2	35.8	105.5	29.9	93.8	24.8	82.0	20.2	70.3	16.2	58.6	12.9	46.9	10.1	35.2	8.01
-7.0	-7.6	111.6	111.6	35.5	100.4	29.7	89.2	24.5	78.1	20.0	66.9	16.1	55.8	12.8	44.6	10.0	33.5	7.94
-10	-10.5	103.4	103.4	35.0	93.0	29.3	82.7	24.2	72.3	19.8	62.0	15.9	51.7	12.6	41.3	9.92	31.0	7.84
-14.5	-15.0	90.6	90.6	34.3	81.6	28.8	72.5	23.8	63.4	19.4	54.4	15.6	45.3	12.4	36.3	9.73	27.2	7.69

TC : Total Capacity PI : Power Input
 Indoor air temperature conditions : 20.0 °C dry-bulb



MMY-AP5016HT7P (50HP, 140.4kW system)

Cooling			Compressor + Outdoor Fan Power consumption (kW)															
Outdoor Unit Dry-Bulb (°C)		Outdoor Unit 100% Cooling Capacity (kW)	100%		90%		80%		70%		60%		50%		40%		30%	
			TC (kW)	PI (kW)	TC (kW)	PI (kW)	TC (kW)	PI (kW)	TC (kW)	PI (kW)	TC (kW)	PI (kW)	TC (kW)	PI (kW)	TC (kW)	PI (kW)	TC (kW)	PI (kW)
40		130.7	130.7	44.5	117.6	36.8	104.5	29.9	91.5	23.7	78.4	18.2	65.3	13.6	52.3	9.66	39.2	6.51
39		132.8	132.8	43.8	119.5	36.3	106.2	29.4	92.9	23.3	79.7	18.0	66.4	13.4	53.1	9.52	39.8	6.41
37		136.7	136.7	42.5	123.0	35.2	109.4	28.5	95.7	22.6	82.0	17.4	68.4	13.0	54.7	9.23	41.0	6.22
35		140.4	140.4	41.2	126.4	34.1	112.3	27.6	98.3	21.9	84.2	16.9	70.2	12.6	56.2	8.94	42.1	6.02
33		140.4	140.4	38.1	126.4	31.6	112.3	25.6	98.3	20.3	84.2	15.7	70.2	11.7	56.2	8.35	42.1	5.65
31		140.4	140.4	35.4	126.4	29.3	112.3	23.8	98.3	18.9	84.2	14.6	70.2	10.9	56.2	7.82	42.1	5.31
30		140.4	140.4	34.2	126.4	28.3	112.3	23.0	98.3	18.3	84.2	14.1	70.2	10.6	56.2	7.57	42.1	5.15
29		140.4	140.4	33.0	126.4	27.3	112.3	22.2	98.3	17.7	84.2	13.7	70.2	10.2	56.2	7.33	42.1	5.00
27		140.4	140.4	30.8	126.4	25.5	112.3	20.8	98.3	16.5	84.2	12.8	70.2	9.58	56.2	6.89	42.1	4.71
25		140.4	140.4	28.8	126.4	23.8	112.3	19.4	98.3	15.5	84.2	12.0	70.2	8.98	56.2	6.47	42.1	4.44
23		140.4	140.4	27.5	126.4	22.8	112.3	18.6	98.3	14.8	84.2	11.5	70.2	8.62	56.2	6.22	42.1	4.28
21		140.4	140.4	26.9	126.4	22.3	112.3	18.2	98.3	14.5	84.2	11.3	70.2	8.46	56.2	6.12	42.1	4.22
20		140.4	140.4	26.7	126.4	22.1	112.3	18.0	98.3	14.4	84.2	11.2	70.2	8.39	56.2	6.07	42.1	4.19
19		140.4	140.4	26.4	126.4	21.9	112.3	17.9	98.3	14.2	84.2	11.1	70.2	8.33	56.2	6.03	42.1	4.16
17		140.4	140.4	26.0	126.4	21.6	112.3	17.6	98.3	14.0	84.2	10.9	70.2	8.22	56.2	5.95	42.1	4.12
15		140.4	140.4	25.6	126.4	21.3	112.3	17.4	98.3	13.8	84.2	10.77	70.2	8.12	56.2	5.89	42.1	4.08

TC : Total Capacity PI : Power Input
 Indoor air temperature conditions : 27.0 °C dry-bulb / 19.0 °C wet-bulb

Heating			Compressor + Outdoor Fan Power consumption (kW)															
Outdoor Unit Dry-Bulb (°C) / Wet-Bulb (°C)		Outdoor Unit 100% Cooling Capacity (kW)	100%		90%		80%		70%		60%		50%		40%		30%	
			TC (kW)	PI (kW)	TC (kW)	PI (kW)	TC (kW)	PI (kW)	TC (kW)	PI (kW)	TC (kW)	PI (kW)	TC (kW)	PI (kW)	TC (kW)	PI (kW)	TC (kW)	PI (kW)
15.0	13.7	156.0	156.0	32.6	140.4	27.7	124.8	23.2	109.2	19.2	93.6	15.7	78.0	12.7	62.4	10.1	46.8	8.00
13.0	11.8	156.0	156.0	33.9	140.4	28.7	124.8	24.0	109.2	19.9	93.6	16.2	78.0	13.0	62.4	10.3	46.8	8.12
11.0	9.8	156.0	156.0	35.4	140.4	29.9	124.8	25.0	109.2	20.6	93.6	16.7	78.0	13.4	62.4	10.6	46.8	8.27
9.0	7.9	156.0	156.0	36.9	140.4	31.2	124.8	26.0	109.2	21.4	93.6	17.3	78.0	13.8	62.4	10.8	46.8	8.42
7.0	6.0	156.0	156.0	38.6	140.4	32.5	124.8	27.1	109.2	22.2	93.6	17.9	78.0	14.2	62.4	11.1	46.8	8.58
5.0	4.1	150.6	150.6	38.3	135.6	32.3	120.5	26.9	105.4	22.1	90.4	17.8	75.3	14.1	60.2	11.0	45.2	8.52
3.0	2.2	145.2	145.2	38.1	130.7	32.1	116.2	26.7	101.7	21.9	87.1	17.7	72.6	14.0	58.1	11.0	43.6	8.46
0.0	-0.7	137.0	137.0	37.6	123.3	31.7	109.6	26.4	95.9	21.7	82.2	17.5	68.5	13.9	54.8	10.8	41.1	8.37
-3.0	-3.7	128.5	128.5	37.2	115.7	31.4	102.8	26.1	90.0	21.4	77.1	17.3	64.3	13.7	51.4	10.7	38.6	8.28
-5.0	-5.6	123.1	123.1	37.0	110.8	31.2	98.5	25.9	86.2	21.3	73.9	17.2	61.6	13.6	49.3	10.6	36.9	8.22
-7.0	-7.6	117.5	117.5	36.7	105.7	30.9	94.0	25.7	82.2	21.1	70.5	17.0	58.7	13.5	47.0	10.6	35.2	8.15
-10	-10.5	109.3	109.3	36.3	98.3	30.6	87.4	25.5	76.5	20.9	65.6	16.8	54.6	13.4	43.7	10.4	32.8	8.06
-14.5	-15.0	96.5	96.5	35.6	86.9	30.1	77.2	25.0	67.6	20.5	57.9	16.6	48.3	13.1	38.6	10.3	29.0	7.92

TC : Total Capacity PI : Power Input
 Indoor air temperature conditions : 20.0 °C dry-bulb



MMY-AP5216HT7P (52HP, 146.0kW system)

Cooling			Compressor + Outdoor Fan Power consumption (kW)															
Outdoor Unit Dry-Bulb (°C)		Outdoor Unit 100% Cooling Capacity (kW)	100%		90%		80%		70%		60%		50%		40%		30%	
			TC (kW)	PI (kW)	TC (kW)	PI (kW)	TC (kW)	PI (kW)	TC (kW)	PI (kW)	TC (kW)	PI (kW)	TC (kW)	PI (kW)	TC (kW)	PI (kW)	TC (kW)	PI (kW)
40		135.9	135.9	48.6	122.3	39.8	108.7	32.0	95.1	25.1	81.5	19.1	67.9	14.0	54.3	9.87	40.8	6.65
39		138.0	138.0	47.9	124.2	39.3	110.4	31.5	96.6	24.7	82.8	18.8	69.0	13.8	55.2	9.73	41.4	6.55
37		142.2	142.2	46.4	128.0	38.1	113.7	30.6	99.5	24.0	85.3	18.2	71.1	13.4	56.9	9.43	42.7	6.36
35		146.0	146.0	45.1	131.4	36.9	116.8	29.6	102.2	23.2	87.6	17.7	73.0	13.0	58.4	9.14	43.8	6.16
33		146.0	146.0	41.6	131.4	34.1	116.8	27.4	102.2	21.5	87.6	16.4	73.0	12.1	58.4	8.53	43.8	5.78
31		146.0	146.0	38.6	131.4	31.6	116.8	25.5	102.2	20.0	87.6	15.3	73.0	11.3	58.4	7.98	43.8	5.44
30		146.0	146.0	37.2	131.4	30.5	116.8	24.5	102.2	19.3	87.6	14.7	73.0	10.9	58.4	7.73	43.8	5.28
29		146.0	146.0	35.9	131.4	29.4	116.8	23.7	102.2	18.6	87.6	14.2	73.0	10.5	58.4	7.48	43.8	5.13
27		146.0	146.0	33.4	131.4	27.4	116.8	22.1	102.2	17.4	87.6	13.3	73.0	9.85	58.4	7.03	43.8	4.83
25		146.0	146.0	31.2	131.4	25.6	116.8	20.6	102.2	16.2	87.6	12.4	73.0	9.23	58.4	6.60	43.8	4.56
23		146.0	146.0	29.8	131.4	24.5	116.8	19.7	102.2	15.5	87.6	11.9	73.0	8.85	58.4	6.34	43.8	4.40
21		146.0	146.0	29.1	131.4	23.9	116.8	19.3	102.2	15.2	87.6	11.7	73.0	8.68	58.4	6.24	43.8	4.34
20		146.0	146.0	28.8	131.4	23.7	116.8	19.1	102.2	15.1	87.6	11.6	73.0	8.61	58.4	6.19	43.8	4.31
19		146.0	146.0	28.5	131.4	23.5	116.8	18.9	102.2	14.9	87.6	11.5	73.0	8.54	58.4	6.15	43.8	4.29
17		146.0	146.0	28.1	131.4	23.1	116.8	18.6	102.2	14.7	87.6	11.3	73.0	8.42	58.4	6.07	43.8	4.24
15		146.0	146.0	27.6	131.4	22.7	116.8	18.4	102.2	14.5	87.6	11.15	73.0	8.32	58.4	6.00	43.8	4.21

TC : Total Capacity PI : Power Input
 Indoor air temperature conditions : 27.0 °C dry-bulb / 19.0 °C wet-bulb

Heating			Compressor + Outdoor Fan Power consumption (kW)															
Outdoor Unit		Outdoor Unit 100% Cooling Capacity (kW)	100%		90%		80%		70%		60%		50%		40%		30%	
Dry-Bulb (°C)	Wet-Bulb (°C)		TC (kW)	PI (kW)	TC (kW)	PI (kW)	TC (kW)	PI (kW)	TC (kW)	PI (kW)	TC (kW)	PI (kW)	TC (kW)	PI (kW)	TC (kW)	PI (kW)	TC (kW)	PI (kW)
15.0	13.7	163.0	163.0	35.1	146.7	29.8	130.4	25.0	114.1	20.7	97.8	16.8	81.5	13.5	65.2	10.7	48.9	8.35
13.0	11.8	163.0	163.0	36.5	146.7	30.9	130.4	25.9	114.1	21.4	97.8	17.4	81.5	13.9	65.2	10.9	48.9	8.49
11.0	9.8	163.0	163.0	38.1	146.7	32.2	130.4	26.9	114.1	22.2	97.8	18.0	81.5	14.3	65.2	11.2	48.9	8.66
9.0	7.9	163.0	163.0	39.7	146.7	33.6	130.4	28.0	114.1	23.0	97.8	18.6	81.5	14.8	65.2	11.5	48.9	8.82
7.0	6.0	163.0	163.0	41.5	146.7	35.0	130.4	29.2	114.1	23.9	97.8	19.3	81.5	15.2	65.2	11.8	48.9	9.01
5.0	4.1	157.2	157.2	41.2	141.4	34.8	125.7	28.9	110.0	23.7	94.3	19.1	78.6	15.1	62.9	11.7	47.1	8.94
3.0	2.2	151.3	151.3	40.9	136.2	34.5	121.1	28.7	105.9	23.5	90.8	19.0	75.7	15.0	60.5	11.6	45.4	8.87
0.0	-0.7	142.4	142.4	40.4	128.2	34.1	113.9	28.4	99.7	23.3	85.4	18.7	71.2	14.8	57.0	11.5	42.7	8.77
-3.0	-3.7	133.2	133.2	39.9	119.9	33.7	106.6	28.0	93.2	23.0	79.9	18.5	66.6	14.6	53.3	11.4	40.0	8.66
-5.0	-5.6	127.4	127.4	39.6	114.6	33.4	101.9	27.8	89.2	22.8	76.4	18.4	63.7	14.5	50.9	11.3	38.2	8.59
-7.0	-7.6	121.2	121.2	39.2	109.1	33.1	97.0	27.6	84.9	22.6	72.7	18.2	60.6	14.4	48.5	11.2	36.4	8.52
-10	-10.5	112.3	112.3	38.8	101.1	32.7	89.8	27.2	78.6	22.3	67.4	18.0	56.2	14.2	44.9	11.0	33.7	8.41
-14.5	-15.0	98.5	98.5	38.0	88.6	32.1	78.8	26.7	68.9	21.9	59.1	17.6	49.2	14.0	39.4	10.8	29.5	8.25

TC : Total Capacity PI : Power Input
 Indoor air temperature conditions : 20.0 °C dry-bulb



MMY-AP5416HT7P (54HP, 151.5kW system)

Cooling			Compressor + Outdoor Fan Power consumption (kW)															
Outdoor Unit Dry-Bulb (°C)		Outdoor Unit 100% Cooling Capacity (kW)	100%		90%		80%		70%		60%		50%		40%		30%	
			TC (kW)	PI (kW)	TC (kW)	PI (kW)	TC (kW)	PI (kW)	TC (kW)	PI (kW)	TC (kW)	PI (kW)	TC (kW)	PI (kW)	TC (kW)	PI (kW)	TC (kW)	PI (kW)
40		141.0	141.0	52.1	126.9	42.6	112.8	34.2	98.7	26.8	84.6	20.3	70.5	14.8	56.4	10.4	42.3	6.89
39		143.2	143.2	51.3	128.9	42.0	114.6	33.7	100.3	26.4	85.9	20.0	71.6	14.6	57.3	10.2	43.0	6.79
37		147.5	147.5	49.7	132.8	40.7	118.0	32.7	103.3	25.6	88.5	19.4	73.8	14.2	59.0	9.91	44.3	6.58
35		151.5	151.5	48.2	136.4	39.5	121.2	31.7	106.1	24.8	90.9	18.8	75.8	13.7	60.6	9.60	45.5	6.38
33		151.5	151.5	44.5	136.4	36.5	121.2	29.3	106.1	22.9	90.9	17.4	75.8	12.8	60.6	8.95	45.5	5.98
31		151.5	151.5	41.3	136.4	33.9	121.2	27.2	106.1	21.3	90.9	16.2	75.8	11.9	60.6	8.37	45.5	5.62
30		151.5	151.5	39.8	136.4	32.6	121.2	26.2	106.1	20.6	90.9	15.7	75.8	11.5	60.6	8.10	45.5	5.45
29		151.5	151.5	38.4	136.4	31.5	121.2	25.3	106.1	19.8	90.9	15.1	75.8	11.1	60.6	7.84	45.5	5.29
27		151.5	151.5	35.8	136.4	29.3	121.2	23.6	106.1	18.5	90.9	14.1	75.8	10.4	60.6	7.35	45.5	4.98
25		151.5	151.5	33.4	136.4	27.4	121.2	22.0	106.1	17.3	90.9	13.2	75.8	9.74	60.6	6.91	45.5	4.70
23		151.5	151.5	31.8	136.4	26.1	121.2	21.0	106.1	16.5	90.9	12.6	75.8	9.33	60.6	6.63	45.5	4.52
21		151.5	151.5	31.1	136.4	25.6	121.2	20.6	106.1	16.2	90.9	12.4	75.8	9.16	60.6	6.52	45.5	4.46
20		151.5	151.5	30.8	136.4	25.3	121.2	20.4	106.1	16.0	90.9	12.3	75.8	9.08	60.6	6.47	45.5	4.43
19		151.5	151.5	30.5	136.4	25.1	121.2	20.2	106.1	15.9	90.9	12.2	75.8	9.01	60.6	6.42	45.5	4.41
17		151.5	151.5	30.0	136.4	24.7	121.2	19.9	106.1	15.6	90.9	12.0	75.8	8.88	60.6	6.34	45.5	4.36
15		151.5	151.5	29.6	136.4	24.3	121.2	19.6	106.1	15.4	90.9	11.8	75.8	8.77	60.6	6.27	45.5	4.32

TC : Total Capacity PI : Power Input
 Indoor air temperature conditions : 27.0 °C dry-bulb / 19.0 °C wet-bulb

Heating			Compressor + Outdoor Fan Power consumption (kW)															
Outdoor Unit		Outdoor Unit 100% Cooling Capacity (kW)	100%		90%		80%		70%		60%		50%		40%		30%	
Dry-Bulb (°C)	Wet-Bulb (°C)		TC (kW)	PI (kW)	TC (kW)	PI (kW)	TC (kW)	PI (kW)	TC (kW)	PI (kW)	TC (kW)	PI (kW)	TC (kW)	PI (kW)	TC (kW)	PI (kW)	TC (kW)	PI (kW)
15.0	13.7	164.0	164.0	35.2	147.6	29.9	131.2	25.1	114.8	20.7	98.4	16.9	82.0	13.6	65.6	10.8	49.2	8.41
13.0	11.8	164.0	164.0	36.6	147.6	31.0	131.2	26.0	114.8	21.4	98.4	17.4	82.0	14.0	65.6	11.0	49.2	8.56
11.0	9.8	164.0	164.0	38.2	147.6	32.3	131.2	27.0	114.8	22.2	98.4	18.0	82.0	14.4	65.6	11.3	49.2	8.72
9.0	7.9	164.0	164.0	39.8	147.6	33.7	131.2	28.1	114.8	23.1	98.4	18.7	82.0	14.8	65.6	11.6	49.2	8.89
7.0	6.0	164.0	164.0	41.6	147.6	35.1	131.2	29.2	114.8	24.0	98.4	19.3	82.0	15.3	65.6	11.9	49.2	9.08
5.0	4.1	158.1	158.1	41.3	142.3	34.8	126.5	29.0	110.7	23.8	94.9	19.2	79.1	15.2	63.2	11.8	47.4	9.01
3.0	2.2	152.3	152.3	41.0	137.0	34.6	121.8	28.8	106.6	23.6	91.4	19.0	76.1	15.1	60.9	11.7	45.7	8.94
0.0	-0.7	143.3	143.3	40.5	129.0	34.2	114.6	28.5	100.3	23.3	86.0	18.8	71.6	14.9	57.3	11.6	43.0	8.83
-3.0	-3.7	134.0	134.0	40.0	120.6	33.7	107.2	28.1	93.8	23.1	80.4	18.6	67.0	14.7	53.6	11.4	40.2	8.72
-5.0	-5.6	128.1	128.1	39.7	115.3	33.5	102.5	27.9	89.7	22.9	76.9	18.4	64.1	14.6	51.3	11.3	38.4	8.66
-7.0	-7.6	122.0	122.0	39.3	109.8	33.2	97.6	27.6	85.4	22.7	73.2	18.3	61.0	14.5	48.8	11.2	36.6	8.58
-10	-10.5	113.0	113.0	38.8	101.7	32.8	90.4	27.3	79.1	22.4	67.8	18.1	56.5	14.3	45.2	11.1	33.9	8.48
-14.5	-15.0	99.1	99.1	38.1	89.2	32.2	79.3	26.8	69.4	22.0	59.5	17.7	49.5	14.0	39.6	10.9	29.7	8.31

TC : Total Capacity PI : Power Input
 Indoor air temperature conditions : 20.0 °C dry-bulb



MMY-AP5616HT7P (56HP, 157.0kW system)

Cooling			Compressor + Outdoor Fan Power consumption (kW)															
Outdoor Unit Dry-Bulb (°C)		Outdoor Unit 100% Cooling Capacity (kW)	100%		90%		80%		70%		60%		50%		40%		30%	
			TC (kW)	PI (kW)	TC (kW)	PI (kW)	TC (kW)	PI (kW)	TC (kW)	PI (kW)	TC (kW)	PI (kW)	TC (kW)	PI (kW)	TC (kW)	PI (kW)	TC (kW)	PI (kW)
40		146.1	146.1	53.1	131.5	43.4	116.9	34.8	102.3	27.2	87.7	20.6	73.1	15.1	58.4	10.7	43.8	7.26
39		148.4	148.4	52.4	133.6	42.8	118.8	34.3	103.9	26.8	89.1	20.3	74.2	14.9	59.4	10.5	44.5	7.15
37		152.9	152.9	50.8	137.6	41.5	122.3	33.2	107.0	25.9	91.7	19.7	76.4	14.4	61.2	10.2	45.9	6.93
35		157.0	157.0	49.4	141.3	40.2	125.6	32.2	109.9	25.1	94.2	19.1	78.5	14.0	62.8	9.86	47.1	6.71
33		157.0	157.0	45.4	141.3	37.2	125.6	29.8	109.9	23.3	94.2	17.7	78.5	13.0	62.8	9.21	47.1	6.31
31		157.0	157.0	42.1	141.3	34.5	125.6	27.6	109.9	21.6	94.2	16.5	78.5	12.12	62.8	8.62	47.1	5.95
30		157.0	157.0	40.6	141.3	33.2	125.6	26.6	109.9	20.9	94.2	15.9	78.5	11.72	62.8	8.35	47.1	5.78
29		157.0	157.0	39.1	141.3	32.0	125.6	25.7	109.9	20.1	94.2	15.4	78.5	11.33	62.8	8.09	47.1	5.61
27		157.0	157.0	36.4	141.3	29.8	125.6	24.0	109.9	18.8	94.2	14.3	78.5	10.61	62.8	7.60	47.1	5.30
25		157.0	157.0	34.0	141.3	27.8	125.6	22.4	109.9	17.6	94.2	13.4	78.5	9.94	62.8	7.14	47.1	5.00
23		157.0	157.0	32.4	141.3	26.6	125.6	21.4	109.9	16.8	94.2	12.8	78.5	9.53	62.8	6.86	47.1	4.83
21		157.0	157.0	31.7	141.3	26.0	125.6	20.9	109.9	16.4	94.2	12.6	78.5	9.36	62.8	6.75	47.1	4.77
20		157.0	157.0	31.4	141.3	25.7	125.6	20.7	109.9	16.3	94.2	12.5	78.5	9.28	62.8	6.70	47.1	4.74
19		157.0	157.0	31.1	141.3	25.5	125.6	20.5	109.9	16.1	94.2	12.4	78.5	9.21	62.8	6.66	47.1	4.72
17		157.0	157.0	30.6	141.3	25.1	125.6	20.2	109.9	15.9	94.2	12.2	78.5	9.08	62.8	6.58	47.1	4.67
15		157.0	157.0	30.1	141.3	24.7	125.6	19.9	109.9	15.7	94.2	12.0	78.5	8.97	62.8	6.51	47.1	4.63

TC : Total Capacity PI : Power Input
 Indoor air temperature conditions : 27.0 °C dry-bulb / 19.0 °C wet-bulb

Heating			Compressor + Outdoor Fan Power consumption (kW)															
Outdoor Unit Dry-Bulb (°C) / Wet-Bulb (°C)		Outdoor Unit 100% Cooling Capacity (kW)	100%		90%		80%		70%		60%		50%		40%		30%	
			TC (kW)	PI (kW)	TC (kW)	PI (kW)	TC (kW)	PI (kW)	TC (kW)	PI (kW)	TC (kW)	PI (kW)	TC (kW)	PI (kW)	TC (kW)	PI (kW)	TC (kW)	PI (kW)
15.0	13.7	176.0	176.0	38.7	158.4	33.0	140.8	27.8	123.2	23.1	105.6	18.8	88.0	15.0	70.4	11.6	52.8	8.77
13.0	11.8	176.0	176.0	40.2	158.4	34.3	140.8	28.8	123.2	23.9	105.6	19.4	88.0	15.4	70.4	11.9	52.8	8.96
11.0	9.8	176.0	176.0	41.9	158.4	35.6	140.8	29.9	123.2	24.7	105.6	20.1	88.0	15.9	70.4	12.3	52.8	9.17
9.0	7.9	176.0	176.0	43.6	158.4	37.1	140.8	31.1	123.2	25.7	105.6	20.8	88.0	16.4	70.4	12.6	52.8	9.39
7.0	6.0	176.0	176.0	45.5	158.4	38.6	140.8	32.3	123.2	26.6	105.6	21.5	88.0	17.0	70.4	13.0	52.8	9.62
5.0	4.1	169.7	169.7	45.1	152.7	38.3	135.8	32.1	118.8	26.4	101.8	21.4	84.8	16.8	67.9	12.9	50.9	9.55
3.0	2.2	163.4	163.4	44.8	147.1	38.0	130.7	31.9	114.4	26.2	98.0	21.2	81.7	16.7	65.4	12.8	49.0	9.47
0.0	-0.7	153.8	153.8	44.3	138.4	37.6	123.0	31.5	107.6	25.9	92.3	20.9	76.9	16.5	61.5	12.7	46.1	9.36
-3.0	-3.7	143.8	143.8	43.7	129.4	37.1	115.1	31.1	100.7	25.6	86.3	20.7	71.9	16.3	57.5	12.5	43.1	9.25
-5.0	-5.6	137.5	137.5	43.4	123.8	36.8	110.0	30.8	96.3	25.4	82.5	20.5	68.8	16.2	55.0	12.4	41.3	9.17
-7.0	-7.6	130.9	130.9	43.0	117.8	36.5	104.7	30.6	91.6	25.2	78.5	20.3	65.4	16.1	52.4	12.3	39.3	9.10
-10	-10.5	121.3	121.3	42.5	109.1	36.1	97.0	30.2	84.9	24.9	72.8	20.1	60.6	15.9	48.5	12.1	36.4	8.99
-14.5	-15.0	106.3	106.3	41.7	95.7	35.4	85.1	29.6	74.4	24.4	63.8	19.7	53.2	15.5	42.5	11.9	31.9	8.81

TC : Total Capacity PI : Power Input
 Indoor air temperature conditions : 20.0 °C dry-bulb



MMY-AP5816HT7P (58HP, 162.5kW system)

Cooling			Compressor + Outdoor Fan Power consumption (kW)															
Outdoor Unit Dry-Bulb (°C)		Outdoor Unit 100% Cooling Capacity (kW)	100%		90%		80%		70%		60%		50%		40%		30%	
			TC (kW)	PI (kW)	TC (kW)	PI (kW)	TC (kW)	PI (kW)	TC (kW)	PI (kW)	TC (kW)	PI (kW)	TC (kW)	PI (kW)	TC (kW)	PI (kW)	TC (kW)	PI (kW)
40		151.2	151.2	56.6	136.1	46.2	121.0	37.0	105.9	27.2	90.7	21.8	75.6	15.9	60.5	11.2	45.4	7.50
39		153.6	153.6	55.8	138.3	45.5	122.9	36.4	107.6	26.8	92.2	21.5	76.8	15.7	61.5	11.0	46.1	7.38
37		158.2	158.2	54.1	142.4	44.2	126.6	35.3	110.8	25.9	94.9	20.9	79.1	15.2	63.3	10.7	47.5	7.16
35		162.5	162.5	52.5	146.3	42.8	130.0	34.2	113.8	25.1	97.5	20.2	81.3	14.7	65.0	10.3	48.8	6.94
33		162.5	162.5	48.4	146.3	39.5	130.0	31.6	113.8	23.3	97.5	18.7	81.3	13.7	65.0	9.63	48.8	6.51
31		162.5	162.5	44.8	146.3	36.7	130.0	29.4	113.8	21.6	97.5	17.4	81.3	12.8	65.0	9.01	48.8	6.13
30		162.5	162.5	43.2	146.3	35.3	130.0	28.3	113.8	20.9	97.5	16.8	81.3	12.3	65.0	8.72	48.8	5.95
29		162.5	162.5	41.7	146.3	34.1	130.0	27.3	113.8	20.1	97.5	16.2	81.3	11.9	65.0	8.44	48.8	5.78
27		162.5	162.5	38.8	146.3	31.7	130.0	25.5	113.8	18.8	97.5	15.2	81.3	11.2	65.0	7.92	48.8	5.45
25		162.5	162.5	36.2	146.3	29.6	130.0	23.8	113.8	17.6	97.5	14.2	81.3	10.5	65.0	7.44	48.8	5.14
23		162.5	162.5	34.5	146.3	28.3	130.0	22.7	113.8	16.8	97.5	13.6	81.3	10.0	65.0	7.15	48.8	4.96
21		162.5	162.5	33.8	146.3	27.6	130.0	22.2	113.8	16.4	97.5	13.3	81.3	9.83	65.0	7.03	48.8	4.89
20		162.5	162.5	33.4	146.3	27.4	130.0	22.0	113.8	16.3	97.5	13.2	81.3	9.75	65.0	6.98	48.8	4.86
19		162.5	162.5	33.1	146.3	27.1	130.0	21.8	113.8	16.1	97.5	13.1	81.3	9.67	65.0	6.93	48.8	4.84
17		162.5	162.5	32.5	146.3	26.6	130.0	21.4	113.8	15.9	97.5	12.9	81.3	9.53	65.0	6.84	48.8	4.79
15		162.5	162.5	32.0	146.3	26.3	130.0	21.1	113.8	15.7	97.5	12.7	81.3	9.41	65.0	6.77	48.8	4.75

TC : Total Capacity PI : Power Input
 Indoor air temperature conditions : 27.0 °C dry-bulb / 19.0 °C wet-bulb

Heating			Compressor + Outdoor Fan Power consumption (kW)															
Outdoor Unit		Outdoor Unit 100% Cooling Capacity (kW)	100%		90%		80%		70%		60%		50%		40%		30%	
Dry-Bulb (°C)	Wet-Bulb (°C)		TC (kW)	PI (kW)	TC (kW)	PI (kW)	TC (kW)	PI (kW)	TC (kW)	PI (kW)	TC (kW)	PI (kW)	TC (kW)	PI (kW)	TC (kW)	PI (kW)	TC (kW)	PI (kW)
15.0	13.7	177.0	177.0	38.8	159.3	33.1	141.6	27.9	123.9	23.1	106.2	18.9	88.5	15.1	70.8	11.7	53.1	8.84
13.0	11.8	177.0	177.0	40.3	159.3	34.3	141.6	28.9	123.9	23.9	106.2	19.5	88.5	15.5	70.8	12.0	53.1	9.03
11.0	9.8	177.0	177.0	42.0	159.3	35.7	141.6	30.0	123.9	24.8	106.2	20.1	88.5	16.0	70.8	12.4	53.1	9.24
9.0	7.9	177.0	177.0	43.7	159.3	37.2	141.6	31.2	123.9	25.7	106.2	20.8	88.5	16.5	70.8	12.7	53.1	9.45
7.0	6.0	177.0	177.0	45.6	159.3	38.7	141.6	32.4	123.9	26.7	106.2	21.6	88.5	17.0	70.8	13.1	53.1	9.69
5.0	4.1	170.7	170.7	45.2	153.6	38.4	136.5	32.2	119.5	26.5	102.4	21.4	85.3	16.9	68.3	13.0	51.2	9.61
3.0	2.2	164.3	164.3	44.9	147.9	38.1	131.5	31.9	115.0	26.3	98.6	21.3	82.2	16.8	65.7	12.9	49.3	9.54
0.0	-0.7	154.6	154.6	44.4	139.2	37.7	123.7	31.6	108.3	26.0	92.8	21.0	77.3	16.6	61.9	12.7	46.4	9.43
-3.0	-3.7	144.6	144.6	43.8	130.2	37.2	115.7	31.2	101.2	25.7	86.8	20.8	72.3	16.4	57.9	12.6	43.4	9.31
-5.0	-5.6	138.3	138.3	43.5	124.5	36.9	110.6	30.9	96.8	25.5	83.0	20.6	69.2	16.3	55.3	12.5	41.5	9.24
-7.0	-7.6	131.6	131.6	43.1	118.5	36.6	105.3	30.7	92.1	25.3	79.0	20.4	65.8	16.1	52.7	12.4	39.5	9.16
-10	-10.5	122.0	122.0	42.6	109.8	36.2	97.6	30.3	85.4	25.0	73.2	20.2	61.0	15.9	48.8	12.2	36.6	9.05
-14.5	-15.0	106.9	106.9	41.8	96.3	35.5	85.6	29.7	74.9	24.5	64.2	19.8	53.5	15.6	42.8	12.0	32.1	8.87

TC : Total Capacity PI : Power Input
 Indoor air temperature conditions : 20.0 °C dry-bulb



MMY-AP6016HT7P (60HP, 168.0kW system)

Cooling			Compressor + Outdoor Fan Power consumption (kW)															
Outdoor Unit Dry-Bulb (°C)		Outdoor Unit 100% Cooling Capacity (kW)	100%		90%		80%		70%		60%		50%		40%		30%	
			TC (kW)	PI (kW)	TC (kW)	PI (kW)	TC (kW)	PI (kW)	TC (kW)	PI (kW)	TC (kW)	PI (kW)	TC (kW)	PI (kW)	TC (kW)	PI (kW)	TC (kW)	PI (kW)
40		156.3	156.3	60.1	140.7	49.0	125.1	39.2	109.4	30.5	93.8	23.0	78.2	16.8	62.5	11.7	46.9	7.73
39		158.8	158.8	59.2	143.0	48.3	127.1	38.6	111.2	30.1	95.3	22.7	79.4	16.5	63.5	11.5	47.7	7.62
37		163.6	163.6	57.4	147.2	46.8	130.9	37.4	114.5	29.2	98.2	22.0	81.8	16.0	65.4	11.1	49.1	7.39
35		168.0	168.0	55.6	151.2	45.4	134.4	36.3	117.6	28.2	100.8	21.3	84.0	15.5	67.2	10.8	50.4	7.16
33		168.0	168.0	51.3	151.2	41.9	134.4	33.5	117.6	26.1	100.8	19.8	84.0	14.4	67.2	10.1	50.4	6.71
31		168.0	168.0	47.6	151.2	38.9	134.4	31.1	117.6	24.3	100.8	18.4	84.0	13.4	67.2	9.40	50.4	6.31
30		168.0	168.0	45.8	151.2	37.5	134.4	30.0	117.6	23.4	100.8	17.7	84.0	13.0	67.2	9.09	50.4	6.12
29		168.0	168.0	44.2	151.2	36.1	134.4	28.9	117.6	22.6	100.8	17.1	84.0	12.5	67.2	8.80	50.4	5.94
27		168.0	168.0	41.2	151.2	33.7	134.4	27.0	117.6	21.1	100.8	16.0	84.0	11.7	67.2	8.25	50.4	5.60
25		168.0	168.0	38.4	151.2	31.4	134.4	25.2	117.6	19.7	100.8	14.9	84.0	11.0	67.2	7.75	50.4	5.28
23		168.0	168.0	36.6	151.2	30.0	134.4	24.0	117.6	18.8	100.8	14.3	84.0	10.5	67.2	7.44	50.4	5.09
21		168.0	168.0	35.8	151.2	29.3	134.4	23.5	117.6	18.4	100.8	14.0	84.0	10.3	67.2	7.31	50.4	5.02
20		168.0	168.0	35.4	151.2	29.0	134.4	23.3	117.6	18.2	100.8	13.9	84.0	10.2	67.2	7.25	50.4	4.98
19		168.0	168.0	35.1	151.2	28.7	134.4	23.0	117.6	18.1	100.8	13.8	84.0	10.1	67.2	7.20	50.4	4.96
17		168.0	168.0	34.5	151.2	28.2	134.4	22.7	117.6	17.8	100.8	13.5	84.0	9.99	67.2	7.11	50.4	4.90
15		168.0	168.0	34.0	151.2	27.8	134.4	22.3	117.6	17.5	100.8	13.4	84.0	9.86	67.2	7.03	50.4	4.86

TC : Total Capacity PI : Power Input
 Indoor air temperature conditions : 27.0 °C dry-bulb / 19.0 °C wet-bulb

Heating			Compressor + Outdoor Fan Power consumption (kW)															
Outdoor Unit Dry-Bulb (°C) / Wet-Bulb (°C)		Outdoor Unit 100% Cooling Capacity (kW)	100%		90%		80%		70%		60%		50%		40%		30%	
			TC (kW)	PI (kW)	TC (kW)	PI (kW)	TC (kW)	PI (kW)	TC (kW)	PI (kW)	TC (kW)	PI (kW)	TC (kW)	PI (kW)	TC (kW)	PI (kW)	TC (kW)	PI (kW)
15.0	13.7	178.0	178.0	38.9	160.2	33.2	142.4	28.0	124.6	23.2	106.8	18.9	89.0	15.1	71.2	11.8	53.4	8.91
13.0	11.8	178.0	178.0	40.4	160.2	34.4	142.4	29.0	124.6	24.0	106.8	19.5	89.0	15.6	71.2	12.1	53.4	9.09
11.0	9.8	178.0	178.0	42.1	160.2	35.8	142.4	30.1	124.6	24.9	106.8	20.2	89.0	16.1	71.2	12.4	53.4	9.31
9.0	7.9	178.0	178.0	43.8	160.2	37.3	142.4	31.3	124.6	25.8	106.8	20.9	89.0	16.6	71.2	12.8	53.4	9.52
7.0	6.0	178.0	178.0	45.7	160.2	38.8	142.4	32.5	124.6	26.8	106.8	21.7	89.0	17.1	71.2	13.1	53.4	9.76
5.0	4.1	171.6	171.6	45.3	154.5	38.5	137.3	32.3	120.1	26.6	103.0	21.5	85.8	17.0	68.6	13.0	51.5	9.68
3.0	2.2	165.2	165.2	45.0	148.7	38.2	132.2	32.0	115.7	26.4	99.1	21.3	82.6	16.9	66.1	12.9	49.6	9.61
0.0	-0.7	155.5	155.5	44.5	140.0	37.8	124.4	31.6	108.9	26.1	93.3	21.1	77.8	16.7	62.2	12.8	46.7	9.49
-3.0	-3.7	145.5	145.5	43.9	130.9	37.3	116.4	31.3	101.8	25.8	87.3	20.8	72.7	16.5	58.2	12.6	43.6	9.38
-5.0	-5.6	139.1	139.1	43.6	125.2	37.0	111.3	31.0	97.4	25.6	83.4	20.7	69.5	16.3	55.6	12.5	41.7	9.30
-7.0	-7.6	132.4	132.4	43.2	119.1	36.7	105.9	30.8	92.7	25.3	79.4	20.5	66.2	16.2	52.9	12.4	39.7	9.22
-10	-10.5	122.6	122.6	42.7	110.4	36.3	98.1	30.4	85.9	25.0	73.6	20.2	61.3	16.0	49.1	12.3	36.8	9.11
-14.5	-15.0	107.5	107.5	41.9	96.8	35.6	86.0	29.8	75.3	24.6	64.5	19.9	53.8	15.7	43.0	12.0	32.3	8.94

TC : Total Capacity PI : Power Input
 Indoor air temperature conditions : 20.0 °C dry-bulb



MMY-AP2026HT7P (20HP, 56kW system)

Cooling			Compressor + Outdoor Fan Power consumption (kW)															
Outdoor Unit		Outdoor Unit 100% Cooling Capacity (kW)	100%		90%		80%		70%		60%		50%		40%		30%	
Dry-Bulb (°C)	TC (kW)		PI (kW)	TC (kW)	PI (kW)	TC (kW)	PI (kW)	TC (kW)	PI (kW)	TC (kW)	PI (kW)	TC (kW)	PI (kW)	TC (kW)	PI (kW)	TC (kW)	PI (kW)	
40																		52.1
39	52.9	52.9	15.5	47.7	12.7	42.4	10.2	37.1	8.10	31.8	6.29	26.5	4.79	21.2	3.62	15.9	2.76	
37	54.5	54.5	15.0	49.1	12.3	43.6	9.92	38.2	7.85	32.7	6.10	27.3	4.65	21.8	3.51	16.4	2.68	
35	56.0	56.0	14.5	50.4	11.9	44.8	9.61	39.2	7.61	33.6	5.91	28.0	4.50	22.4	3.40	16.8	2.59	
33	56.0	56.0	13.4	50.4	11.0	44.8	8.91	39.2	7.07	33.6	5.50	28.0	4.21	22.4	3.20	16.8	2.46	
31	56.0	56.0	12.4	50.4	10.2	44.8	8.28	39.2	6.58	33.6	5.14	28.0	3.95	22.4	3.02	16.8	2.34	
30	56.0	56.0	12.0	50.4	9.87	44.8	7.99	39.2	6.36	33.6	4.97	28.0	3.83	22.4	2.94	16.8	2.29	
29	56.0	56.0	11.6	50.4	9.53	44.8	7.72	39.2	6.15	33.6	4.81	28.0	3.71	22.4	2.85	16.8	2.23	
27	56.0	56.0	10.8	50.4	8.89	44.8	7.21	39.2	5.75	33.6	4.51	28.0	3.49	22.4	2.70	16.8	2.12	
25	56.0	56.0	10.1	50.4	8.30	44.8	6.74	39.2	5.39	33.6	4.24	28.0	3.29	22.4	2.55	16.8	2.02	
23	56.0	56.0	9.62	50.4	7.93	44.8	6.45	39.2	5.16	33.6	4.06	28.0	3.17	22.4	2.46	16.8	1.96	
21	56.0	56.0	9.41	50.4	7.77	44.8	6.32	39.2	5.06	33.6	3.99	28.0	3.12	22.4	2.44	16.8	1.94	
20	56.0	56.0	9.31	50.4	7.69	44.8	6.26	39.2	5.02	33.6	3.96	28.0	3.10	22.4	2.42	16.8	1.94	
19	56.0	56.0	9.23	50.4	7.62	44.8	6.21	39.2	4.98	33.6	3.93	28.0	3.08	22.4	2.41	16.8	1.93	
17	56.0	56.0	9.07	50.4	7.50	44.8	6.11	39.2	4.91	33.6	3.88	28.0	3.04	22.4	2.39	16.8	1.92	
15	56.0	56.0	8.94	50.4	7.40	44.8	6.03	39.2	4.84	33.6	3.84	28.0	3.02	22.4	2.37	16.8	1.91	

TC : Total Capacity PI : Power Input
 Indoor air temperature conditions : 27.0 °C dry-bulb / 19.0 °C wet-bulb

Heating			Compressor + Outdoor Fan Power consumption (kW)															
Outdoor Unit		Outdoor Unit 100% Cooling Capacity (kW)	100%		90%		80%		70%		60%		50%		40%		30%	
Dry-Bulb (°C)	Wet-Bulb (°C)		TC (kW)	PI (kW)	TC (kW)	PI (kW)	TC (kW)	PI (kW)	TC (kW)	PI (kW)	TC (kW)	PI (kW)	TC (kW)	PI (kW)	TC (kW)	PI (kW)	TC (kW)	PI (kW)
15.0	13.7																	
13.0	11.8	63.0	63.0	12.5	56.7	10.6	50.4	8.88	44.1	7.35	37.8	5.99	31.5	4.81	25.2	3.80	18.9	2.97
11.0	9.8	63.0	63.0	13.0	56.7	11.0	50.4	9.23	44.1	7.62	37.8	6.20	31.5	4.96	25.2	3.90	18.9	3.03
9.0	7.9	63.0	63.0	13.6	56.7	11.5	50.4	9.59	44.1	7.90	37.8	6.41	31.5	5.11	25.2	4.00	18.9	3.09
7.0	6.0	63.0	63.0	14.2	56.7	12.0	50.4	9.99	44.1	8.21	37.8	6.63	31.5	5.27	25.2	4.11	18.9	3.15
5.0	4.1	61.0	61.0	14.1	54.9	11.9	48.8	9.93	42.7	8.16	36.6	6.60	30.5	5.24	24.4	4.08	18.3	3.13
3.0	2.2	58.9	58.9	14.0	53.1	11.8	47.2	9.87	41.3	8.11	35.4	6.56	29.5	5.21	23.6	4.06	17.7	3.11
0.0	-0.7	55.9	55.9	13.9	50.3	11.7	44.7	9.78	39.1	8.04	33.5	6.50	27.9	5.16	22.3	4.02	16.8	3.09
-3.0	-3.7	52.7	52.7	13.7	47.4	11.6	42.1	9.69	36.9	7.97	31.6	6.44	26.3	5.11	21.1	3.99	15.8	3.06
-5.0	-5.6	50.6	50.6	13.7	45.6	11.6	40.5	9.64	35.4	7.92	30.4	6.40	25.3	5.08	20.3	3.96	15.2	3.04
-7.0	-7.6	48.5	48.5	13.6	43.6	11.5	38.8	9.58	33.9	7.87	29.1	6.36	24.2	5.05	19.4	3.94	14.5	3.02
-10	-10.5	45.4	45.4	13.5	40.9	11.4	36.3	9.49	31.8	7.80	27.2	6.30	22.7	5.01	18.2	3.90	13.6	2.99
-14.5	-15.0	40.6	40.6	13.3	36.5	11.2	32.5	9.35	28.4	7.69	24.4	6.22	20.3	4.93	16.2	3.85	12.18	2.95

TC : Total Capacity PI : Power Input
 Indoor air temperature conditions : 20.0 °C dry-bulb



MMY-AP2226HT7P (22HP, 61.5kW system)

Cooling			Compressor + Outdoor Fan Power consumption (kW)															
Outdoor Unit Dry-Bulb (°C)		Outdoor Unit 100% Cooling Capacity (kW)	100%		90%		80%		70%		60%		50%		40%		30%	
			TC (kW)	PI (kW)	TC (kW)	PI (kW)	TC (kW)	PI (kW)	TC (kW)	PI (kW)	TC (kW)	PI (kW)	TC (kW)	PI (kW)	TC (kW)	PI (kW)	TC (kW)	PI (kW)
40		57.2	57.2	18.0	51.5	14.8	45.8	12.0	40.1	9.50	34.3	7.34	28.6	5.52	22.9	4.04	17.2	2.91
39		58.2	58.2	17.7	52.3	14.6	46.5	11.8	40.7	9.36	34.9	7.23	29.1	5.44	23.3	3.98	17.4	2.86
37		59.9	59.9	17.2	53.9	14.2	47.9	11.5	41.9	9.07	35.9	7.01	29.9	5.28	24.0	3.86	18.0	2.78
35		61.5	61.5	16.7	55.4	13.7	49.2	11.1	43.1	8.79	36.9	6.79	30.8	5.11	24.6	3.74	18.5	2.69
33		61.5	61.5	15.4	55.4	12.7	49.2	10.3	43.1	8.16	36.9	6.32	30.8	4.77	24.6	3.51	18.5	2.54
31		61.5	61.5	14.3	55.4	11.8	49.2	9.57	43.1	7.60	36.9	5.90	30.8	4.46	24.6	3.30	18.5	2.40
30		61.5	61.5	13.8	55.4	11.4	49.2	9.24	43.1	7.34	36.9	5.70	30.8	4.32	24.6	3.20	18.5	2.34
29		61.5	61.5	13.3	55.4	11.0	49.2	8.92	43.1	7.09	36.9	5.51	30.8	4.19	24.6	3.11	18.5	2.28
27		61.5	61.5	12.4	55.4	10.3	49.2	8.33	43.1	6.63	36.9	5.16	30.8	3.93	24.6	2.93	18.5	2.15
25		61.5	61.5	11.6	55.4	9.59	49.2	7.79	43.1	6.21	36.9	4.84	30.8	3.69	24.6	2.76	18.5	2.04
23		61.5	61.5	11.1	55.4	9.16	49.2	7.45	43.1	5.94	36.9	4.64	30.8	3.55	24.6	2.66	18.5	1.97
21		61.5	61.5	10.8	55.4	8.97	49.2	7.30	43.1	5.83	36.9	4.56	30.8	3.49	24.6	2.62	18.5	1.95
20		61.5	61.5	10.7	55.4	8.88	49.2	7.23	43.1	5.78	36.9	4.52	30.8	3.46	24.6	2.60	18.5	1.94
19		61.5	61.5	10.6	55.4	8.81	49.2	7.17	43.1	5.73	36.9	4.49	30.8	3.44	24.6	2.59	18.5	1.94
17		61.5	61.5	10.5	55.4	8.66	49.2	7.06	43.1	5.64	36.9	4.42	30.8	3.40	24.6	2.56	18.5	1.93
15		61.5	61.5	10.3	55.4	8.54	49.2	6.96	43.1	5.57	36.9	4.37	30.8	3.36	24.6	2.54	18.5	1.93

TC : Total Capacity PI : Power Input
 Indoor air temperature conditions : 27.0 °C dry-bulb / 19.0 °C wet-bulb

Heating			Compressor + Outdoor Fan Power consumption (kW)															
Outdoor Unit Dry-Bulb (°C) / Wet-Bulb (°C)		Outdoor Unit 100% Cooling Capacity (kW)	100%		90%		80%		70%		60%		50%		40%		30%	
			TC (kW)	PI (kW)	TC (kW)	PI (kW)	TC (kW)	PI (kW)	TC (kW)	PI (kW)	TC (kW)	PI (kW)	TC (kW)	PI (kW)	TC (kW)	PI (kW)	TC (kW)	PI (kW)
15.0	13.7	69.0	69.0	13.9	62.1	11.8	55.2	9.96	48.3	8.26	41.4	6.74	34.5	5.39	27.6	4.21	20.7	3.21
13.0	11.8	69.0	69.0	14.4	62.1	12.3	55.2	10.3	48.3	8.54	41.4	6.95	34.5	5.54	27.6	4.32	20.7	3.27
11.0	9.8	69.0	69.0	15.0	62.1	12.8	55.2	10.7	48.3	8.86	41.4	7.19	34.5	5.72	27.6	4.44	20.7	3.35
9.0	7.9	69.0	69.0	15.6	62.1	13.3	55.2	11.1	48.3	9.19	41.4	7.44	34.5	5.90	27.6	4.56	20.7	3.42
7.0	6.0	69.0	69.0	16.3	62.1	13.8	55.2	11.6	48.3	9.54	41.4	7.71	34.5	6.09	27.6	4.69	20.7	3.50
5.0	4.1	66.6	66.6	16.2	60.0	13.7	53.3	11.5	46.6	9.47	40.0	7.66	33.3	6.05	26.7	4.66	20.0	3.48
3.0	2.2	64.3	64.3	16.1	57.9	13.7	51.4	11.4	45.0	9.41	38.6	7.60	32.1	6.01	25.7	4.63	19.3	3.46
0.0	-0.7	60.7	60.7	15.9	54.6	13.5	48.6	11.3	42.5	9.31	36.4	7.52	30.3	5.95	24.3	4.58	18.2	3.42
-3.0	-3.7	57.0	57.0	15.8	51.3	13.4	45.6	11.2	39.9	9.21	34.2	7.44	28.5	5.88	22.8	4.53	17.1	3.38
-5.0	-5.6	54.6	54.6	15.6	49.2	13.3	43.7	11.1	38.2	9.14	32.8	7.39	27.3	5.84	21.8	4.50	16.4	3.36
-7.0	-7.6	52.1	52.1	15.5	46.9	13.2	41.7	11.0	36.5	9.08	31.3	7.33	26.1	5.80	20.9	4.46	15.6	3.33
-10	-10.5	48.5	48.5	15.4	43.7	13.0	38.8	10.9	34.0	8.98	29.1	7.25	24.3	5.73	19.4	4.41	14.6	3.30
-14.5	-15.0	43.0	43.0	15.1	38.7	12.8	34.4	10.7	30.1	8.82	25.8	7.13	21.5	5.64	17.2	4.34	12.9	3.24

TC : Total Capacity PI : Power Input
 Indoor air temperature conditions : 20.0 °C dry-bulb



MMY-AP3626HT7P (36HP, 100.5kW system)

Cooling			Compressor + Outdoor Fan Power consumption (kW)															
Outdoor Unit Dry-Bulb (°C)		Outdoor Unit 100% Cooling Capacity (kW)	100%		90%		80%		70%		60%		50%		40%		30%	
			TC (kW)	PI (kW)	TC (kW)	PI (kW)	TC (kW)	PI (kW)	TC (kW)	PI (kW)	TC (kW)	PI (kW)	TC (kW)	PI (kW)	TC (kW)	PI (kW)	TC (kW)	PI (kW)
40		93.5	93.5	30.5	84.2	25.2	74.8	20.4	65.5	16.2	56.1	12.4	46.8	9.27	37.4	6.62	28.1	4.52
39		95.0	95.0	30.0	85.5	24.8	76.0	20.1	66.5	15.9	57.0	12.3	47.5	9.13	38.0	6.53	28.5	4.45
37		97.9	97.9	29.1	88.1	24.1	78.3	19.5	68.5	15.4	58.7	11.9	48.9	8.85	39.1	6.33	29.4	4.31
35		100.5	100.5	28.2	90.5	23.3	80.4	18.9	70.4	15.0	60.3	11.5	50.3	8.58	40.2	6.13	30.2	4.18
33		100.5	100.5	26.1	90.5	21.6	80.4	17.5	70.4	13.9	60.3	10.7	50.3	7.99	40.2	5.73	30.2	3.93
31		100.5	100.5	24.3	90.5	20.1	80.4	16.3	70.4	12.9	60.3	9.98	50.3	7.46	40.2	5.37	30.2	3.69
30		100.5	100.5	23.4	90.5	19.4	80.4	15.7	70.4	12.5	60.3	9.65	50.3	7.22	40.2	5.20	30.2	3.59
29		100.5	100.5	22.6	90.5	18.7	80.4	15.2	70.4	12.1	60.3	9.32	50.3	6.99	40.2	5.04	30.2	3.48
27		100.5	100.5	21.1	90.5	17.4	80.4	14.2	70.4	11.3	60.3	8.73	50.3	6.55	40.2	4.73	30.2	3.28
25		100.5	100.5	19.7	90.5	16.3	80.4	13.3	70.4	10.5	60.3	8.17	50.3	6.14	40.2	4.45	30.2	3.10
23		100.5	100.5	18.8	90.5	15.6	80.4	12.7	70.4	10.1	60.3	7.83	50.3	5.89	40.2	4.28	30.2	2.99
21		100.5	100.5	18.4	90.5	15.3	80.4	12.4	70.4	9.89	60.3	7.68	50.3	5.79	40.2	4.21	30.2	2.95
20		100.5	100.5	18.2	90.5	15.1	80.4	12.3	70.4	9.80	60.3	7.62	50.3	5.74	40.2	4.18	30.2	2.93
19		100.5	100.5	18.1	90.5	15.0	80.4	12.2	70.4	9.72	60.3	7.56	50.3	5.70	40.2	4.15	30.2	2.91
17		100.5	100.5	17.8	90.5	14.7	80.4	12.0	70.4	9.57	60.3	7.45	50.3	5.62	40.2	4.10	30.2	2.91
15		100.5	100.5	17.5	90.5	14.5	80.4	11.8	70.4	9.45	60.3	7.35	50.3	5.56	40.2	4.06	30.2	2.91

TC : Total Capacity PI : Power Input
 Indoor air temperature conditions : 27.0 °C dry-bulb / 19.0 °C wet-bulb

Heating			Compressor + Outdoor Fan Power consumption (kW)															
Outdoor Unit Dry-Bulb (°C) / Wet-Bulb (°C)		Outdoor Unit 100% Cooling Capacity (kW)	100%		90%		80%		70%		60%		50%		40%		30%	
			TC (kW)	PI (kW)	TC (kW)	PI (kW)	TC (kW)	PI (kW)	TC (kW)	PI (kW)	TC (kW)	PI (kW)	TC (kW)	PI (kW)	TC (kW)	PI (kW)	TC (kW)	PI (kW)
15.0	13.7	112.5	112.5	23.6	101.3	20.2	90.0	17.0	78.8	14.1	67.5	11.5	56.3	9.14	45.0	7.06	33.8	5.24
13.0	11.8	112.5	112.5	24.5	101.3	20.9	90.0	17.6	78.8	14.6	67.5	11.9	56.3	9.41	45.0	7.24	33.8	5.36
11.0	9.8	112.5	112.5	25.5	101.3	21.8	90.0	18.3	78.8	15.1	67.5	12.3	56.3	9.72	45.0	7.46	33.8	5.50
9.0	7.9	112.5	112.5	26.6	101.3	22.6	90.0	19.0	78.8	15.7	67.5	12.7	56.3	10.0	45.0	7.68	33.8	5.64
7.0	6.0	112.5	112.5	27.7	101.3	23.6	90.0	19.8	78.8	16.3	67.5	13.2	56.3	10.4	45.0	7.91	33.8	5.78
5.0	4.1	108.5	108.5	27.5	97.6	23.4	86.8	19.6	75.9	16.2	65.1	13.1	54.2	10.3	43.4	7.85	32.5	5.74
3.0	2.2	104.4	104.4	27.3	94.0	23.2	83.6	19.5	73.1	16.1	62.7	13.0	52.2	10.2	41.8	7.79	31.3	5.70
0.0	-0.7	98.3	98.3	27.0	88.5	22.9	78.6	19.2	68.8	15.9	59.0	12.8	49.1	10.1	39.3	7.70	29.5	5.63
-3.0	-3.7	91.9	91.9	26.6	82.7	22.7	73.5	19.0	64.4	15.7	55.2	12.7	46.0	9.97	36.8	7.61	27.6	5.56
-5.0	-5.6	87.9	87.9	26.4	79.1	22.5	70.3	18.9	61.5	15.6	52.7	12.6	44.0	9.89	35.2	7.55	26.4	5.52
-7.0	-7.6	83.7	83.7	26.2	75.3	22.3	66.9	18.7	58.6	15.4	50.2	12.5	41.8	9.81	33.5	7.48	25.1	5.47
-10	-10.5	77.5	77.5	25.9	69.8	22.0	62.0	18.5	54.3	15.2	46.5	12.3	38.8	9.69	31.0	7.39	23.3	5.40
-14.5	-15.0	68.0	68.0	25.4	61.2	21.6	54.4	18.1	47.6	14.9	40.8	12.1	34.0	9.50	27.2	7.25	20.4	5.30

TC : Total Capacity PI : Power Input
 Indoor air temperature conditions : 20.0 °C dry-bulb



MMY-AP3826HT7P (38HP, 107kW system)

Cooling			Compressor + Outdoor Fan Power consumption (kW)															
Outdoor Unit Dry-Bulb (°C)		Outdoor Unit 100% Cooling Capacity (kW)	100%		90%		80%		70%		60%		50%		40%		30%	
			TC (kW)	PI (kW)	TC (kW)	PI (kW)	TC (kW)	PI (kW)	TC (kW)	PI (kW)	TC (kW)	PI (kW)	TC (kW)	PI (kW)	TC (kW)	PI (kW)	TC (kW)	PI (kW)
40		99.6	99.6	32.8	89.6	27.1	79.7	21.9	69.7	17.4	59.7	13.4	49.8	9.97	39.8	7.14	29.9	4.88
39		101.2	101.2	32.3	91.1	26.7	80.9	21.6	70.8	17.1	60.7	13.2	50.6	9.82	40.5	7.03	30.4	4.81
37		104.2	104.2	31.3	93.8	25.8	83.4	20.9	72.9	16.6	62.5	12.8	52.1	9.53	41.7	6.82	31.3	4.66
35		107.0	107.0	30.3	96.3	25.0	85.6	20.3	74.9	16.1	64.2	12.4	53.5	9.23	42.8	6.61	32.1	4.52
33		107.0	107.0	28.1	96.3	23.2	85.6	18.8	74.9	14.9	64.2	11.5	53.5	8.60	42.8	6.18	32.1	4.24
31		107.0	107.0	26.1	96.3	21.6	85.6	17.5	74.9	13.9	64.2	10.7	53.5	8.03	42.8	5.79	32.1	4.00
30		107.0	107.0	25.2	96.3	20.8	85.6	16.9	74.9	13.4	64.2	10.4	53.5	7.77	42.8	5.61	32.1	3.88
29		107.0	107.0	24.3	96.3	20.1	85.6	16.3	74.9	13.0	64.2	10.0	53.5	7.52	42.8	5.43	32.1	3.77
27		107.0	107.0	22.6	96.3	18.7	85.6	15.2	74.9	12.1	64.2	9.39	53.5	7.05	42.8	5.11	32.1	3.55
25		107.0	107.0	21.2	96.3	17.5	85.6	14.2	74.9	11.3	64.2	8.79	53.5	6.61	42.8	4.80	32.1	3.35
23		107.0	107.0	20.2	96.3	16.7	85.6	13.6	74.9	10.8	64.2	8.42	53.5	6.35	42.8	4.62	32.1	3.23
21		107.0	107.0	19.8	96.3	16.4	85.6	13.3	74.9	10.6	64.2	8.27	53.5	6.23	42.8	4.54	32.1	3.19
20		107.0	107.0	19.6	96.3	16.2	85.6	13.2	74.9	10.5	64.2	8.19	53.5	6.18	42.8	4.51	32.1	3.17
19		107.0	107.0	19.4	96.3	16.1	85.6	13.1	74.9	10.5	64.2	8.13	53.5	6.14	42.8	4.48	32.1	3.15
17		107.0	107.0	19.1	96.3	15.8	85.6	12.9	74.9	10.3	64.2	8.01	53.5	6.06	42.8	4.43	32.1	3.14
15		107.0	107.0	18.8	96.3	15.6	85.6	12.7	74.9	10.2	64.2	7.91	53.5	5.98	42.8	4.38	32.1	3.13

TC : Total Capacity PI : Power Input
 Indoor air temperature conditions : 27.0 °C dry-bulb / 19.0 °C wet-bulb

Heating			Compressor + Outdoor Fan Power consumption (kW)															
Outdoor Unit		Outdoor Unit 100% Cooling Capacity (kW)	100%		90%		80%		70%		60%		50%		40%		30%	
Dry-Bulb (°C)	Wet-Bulb (°C)		TC (kW)	PI (kW)	TC (kW)	PI (kW)	TC (kW)	PI (kW)	TC (kW)	PI (kW)	TC (kW)	PI (kW)	TC (kW)	PI (kW)	TC (kW)	PI (kW)	TC (kW)	PI (kW)
15.0	13.7	120.0	120.0	24.7	108.0	21.0	96.0	17.7	84.0	14.6	72.0	12.0	60.0	9.59	48.0	7.55	36.0	5.85
13.0	11.8	120.0	120.0	25.6	108.0	21.8	96.0	18.3	84.0	15.1	72.0	12.3	60.0	9.86	48.0	7.73	36.0	5.95
11.0	9.8	120.0	120.0	26.7	108.0	22.7	96.0	19.0	84.0	15.7	72.0	12.7	60.0	10.2	48.0	7.94	36.0	6.08
9.0	7.9	120.0	120.0	27.9	108.0	23.6	96.0	19.8	84.0	16.3	72.0	13.2	60.0	10.5	48.0	8.15	36.0	6.20
7.0	6.0	120.0	120.0	29.1	108.0	24.6	96.0	20.6	84.0	16.9	72.0	13.7	60.0	10.8	48.0	8.37	36.0	6.34
5.0	4.1	115.9	115.9	28.9	104.3	24.4	92.7	20.4	81.1	16.8	69.5	13.6	57.9	10.7	46.3	8.32	34.8	6.29
3.0	2.2	111.7	111.7	28.7	100.6	24.3	89.4	20.3	78.2	16.7	67.0	13.5	55.9	10.7	44.7	8.26	33.5	6.25
0.0	-0.7	105.4	105.4	28.4	94.9	24.0	84.3	20.1	73.8	16.5	63.3	13.3	52.7	10.6	42.2	8.17	31.6	6.18
-3.0	-3.7	98.9	98.9	28.0	89.0	23.7	79.1	19.8	69.2	16.3	59.3	13.2	49.4	10.4	39.6	8.08	29.7	6.11
-5.0	-5.6	94.8	94.8	27.8	85.3	23.6	75.8	19.7	66.3	16.2	56.9	13.1	47.4	10.4	37.9	8.02	28.4	6.07
-7.0	-7.6	90.4	90.4	27.6	81.4	23.4	72.3	19.5	63.3	16.1	54.2	13.0	45.2	10.3	36.2	7.96	27.1	6.03
-10	-10.5	84.1	84.1	27.3	75.7	23.1	67.3	19.3	58.9	15.9	50.5	12.8	42.1	10.2	33.6	7.87	25.2	5.96
-14.5	-15.0	74.3	74.3	26.9	66.9	22.7	59.5	19.0	52.0	15.6	44.6	12.6	37.2	9.99	29.7	7.74	22.3	5.86

TC : Total Capacity PI : Power Input
 Indoor air temperature conditions : 20.0 °C dry-bulb



MMY-AP4026HT7P (40HP, 113.5kW system)

Cooling			Compressor + Outdoor Fan Power consumption (kW)															
Outdoor Unit Dry-Bulb (°C)		Outdoor Unit 100% Cooling Capacity (kW)	100%		90%		80%		70%		60%		50%		40%		30%	
			TC (kW)	PI (kW)	TC (kW)	PI (kW)	TC (kW)	PI (kW)	TC (kW)	PI (kW)	TC (kW)	PI (kW)	TC (kW)	PI (kW)	TC (kW)	PI (kW)	TC (kW)	PI (kW)
40		105.6	105.6	35.0	95.1	28.9	84.5	23.4	73.9	18.6	63.4	14.3	52.8	10.7	42.2	7.65	31.7	5.25
39		107.3	107.3	34.5	96.6	28.5	85.9	23.1	75.1	18.3	64.4	14.1	53.7	10.5	42.9	7.54	32.2	5.17
37		110.5	110.5	33.5	99.5	27.6	88.4	22.4	77.4	17.7	66.3	13.7	55.3	10.2	44.2	7.31	33.2	5.01
35		113.5	113.5	32.4	102.2	26.8	90.8	21.7	79.5	17.2	68.1	13.2	56.8	9.88	45.4	7.08	34.1	4.85
33		113.5	113.5	30.0	102.2	24.8	90.8	20.1	79.5	16.0	68.1	12.3	56.8	9.21	45.4	6.62	34.1	4.56
31		113.5	113.5	27.9	102.2	23.0	90.8	18.7	79.5	14.9	68.1	11.5	56.8	8.60	45.4	6.21	34.1	4.30
30		113.5	113.5	26.9	102.2	22.2	90.8	18.1	79.5	14.3	68.1	11.1	56.8	8.32	45.4	6.01	34.1	4.17
29		113.5	113.5	25.9	102.2	21.5	90.8	17.4	79.5	13.9	68.1	10.7	56.8	8.05	45.4	5.83	34.1	4.05
27		113.5	113.5	24.2	102.2	20.0	90.8	16.3	79.5	13.0	68.1	10.0	56.8	7.55	45.4	5.48	34.1	3.82
25		113.5	113.5	22.6	102.2	18.7	90.8	15.2	79.5	12.1	68.1	9.41	56.8	7.09	45.4	5.15	34.1	3.61
23		113.5	113.5	21.6	102.2	17.9	90.8	14.6	79.5	11.6	68.1	9.02	56.8	6.80	45.4	4.95	34.1	3.48
21		113.5	113.5	21.1	102.2	17.5	90.8	14.3	79.5	11.4	68.1	8.85	56.8	6.68	45.4	4.87	34.1	3.43
20		113.5	113.5	20.9	102.2	17.4	90.8	14.1	79.5	11.3	68.1	8.77	56.8	6.63	45.4	4.84	34.1	3.41
19		113.5	113.5	20.8	102.2	17.2	90.8	14.0	79.5	11.2	68.1	8.70	56.8	6.58	45.4	4.81	34.1	3.39
17		113.5	113.5	20.4	102.2	16.9	90.8	13.8	79.5	11.0	68.1	8.58	56.8	6.49	45.4	4.75	34.1	3.37
15		113.5	113.5	20.1	102.2	16.7	90.8	13.6	79.5	10.9	68.1	8.47	56.8	6.41	45.4	4.70	34.1	3.35

TC : Total Capacity PI : Power Input
Indoor air temperature conditions : 27.0 °C dry-bulb / 19.0 °C wet-bulb

Heating			Compressor + Outdoor Fan Power consumption (kW)															
Outdoor Unit Dry-Bulb (°C) / Wet-Bulb (°C)		Outdoor Unit 100% Cooling Capacity (kW)	100%		90%		80%		70%		60%		50%		40%		30%	
			TC (kW)	PI (kW)	TC (kW)	PI (kW)	TC (kW)	PI (kW)	TC (kW)	PI (kW)	TC (kW)	PI (kW)	TC (kW)	PI (kW)	TC (kW)	PI (kW)	TC (kW)	PI (kW)
15.0	13.7	127.5	127.5	25.7	114.8	21.8	102.0	18.3	89.3	15.2	76.5	12.4	63.8	10.0	51.0	8.05	38.3	6.45
13.0	11.8	127.5	127.5	26.7	114.8	22.6	102.0	19.0	89.3	15.7	76.5	12.8	63.8	10.3	51.0	8.22	38.3	6.54
11.0	9.8	127.5	127.5	27.9	114.8	23.6	102.0	19.7	89.3	16.3	76.5	13.2	63.8	10.6	51.0	8.42	38.3	6.65
9.0	7.9	127.5	127.5	29.1	114.8	24.6	102.0	20.5	89.3	16.9	76.5	13.7	63.8	10.9	51.0	8.62	38.3	6.77
7.0	6.0	127.5	127.5	30.4	114.8	25.7	102.0	21.3	89.3	17.5	76.5	14.1	63.8	11.3	51.0	8.83	38.3	6.89
5.0	4.1	123.3	123.3	30.2	110.9	25.5	98.6	21.2	86.3	17.4	74.0	14.1	61.6	11.2	49.3	8.78	37.0	6.85
3.0	2.2	119.0	119.0	30.1	107.1	25.3	95.2	21.1	83.3	17.3	71.4	14.0	59.5	11.1	47.6	8.72	35.7	6.80
0.0	-0.7	112.6	112.6	29.8	101.3	25.1	90.0	20.9	78.8	17.1	67.5	13.8	56.3	11.0	45.0	8.64	33.8	6.74
-3.0	-3.7	105.9	105.9	29.5	95.3	24.8	84.7	20.7	74.1	16.9	63.5	13.7	52.9	10.9	42.3	8.55	31.8	6.67
-5.0	-5.6	101.6	101.6	29.3	91.5	24.7	81.3	20.5	71.1	16.8	61.0	13.6	50.8	10.8	40.7	8.50	30.5	6.63
-7.0	-7.6	97.2	97.2	29.1	87.5	24.5	77.7	20.4	68.0	16.7	58.3	13.5	48.6	10.7	38.9	8.44	29.2	6.58
-10	-10.5	90.7	90.7	28.8	81.6	24.3	72.6	20.2	63.5	16.6	54.4	13.4	45.4	10.6	36.3	8.35	27.2	6.52
-14.5	-15.0	80.7	80.7	28.3	72.6	23.9	64.5	19.9	56.5	16.3	48.4	13.2	40.3	10.5	32.3	8.22	24.2	6.41

TC : Total Capacity PI : Power Input
Indoor air temperature conditions : 20.0 °C dry-bulb



MMY-AP4226HT7P (42HP, 120kW system)

Cooling			Compressor + Outdoor Fan Power consumption (kW)															
Outdoor Unit		Outdoor Unit 100% Cooling Capacity (kW)	100%		90%		80%		70%		60%		50%		40%		30%	
Dry-Bulb (°C)	TC		PI	TC	PI	TC	PI	TC	PI	TC	PI	TC	PI	TC	PI	TC	PI	
	(kW)		(kW)	(kW)	(kW)	(kW)	(kW)	(kW)	(kW)	(kW)	(kW)	(kW)	(kW)	(kW)	(kW)	(kW)	(kW)	(kW)
40		111.7	111.7	37.3	100.5	30.8	89.3	25.0	78.2	19.8	67.0	15.3	55.8	11.4	44.7	8.17	33.5	5.61
39		113.5	113.5	36.7	102.1	30.3	90.8	24.6	79.4	19.5	68.1	15.0	56.7	11.2	45.4	8.05	34.0	5.53
37		116.9	116.9	35.6	105.2	29.4	93.5	23.8	81.8	18.9	70.1	14.6	58.4	10.9	46.7	7.80	35.1	5.36
35		120.0	120.0	34.5	108.0	28.5	96.0	23.1	84.0	18.3	72.0	14.1	60.0	10.5	48.0	7.56	36.0	5.19
33		120.0	120.0	31.9	108.0	26.4	96.0	21.4	84.0	17.0	72.0	13.1	60.0	9.82	48.0	7.07	36.0	4.88
31		120.0	120.0	29.7	108.0	24.5	96.0	19.9	84.0	15.8	72.0	12.2	60.0	9.17	48.0	6.63	36.0	4.60
30		120.0	120.0	28.6	108.0	23.7	96.0	19.2	84.0	15.3	72.0	11.8	60.0	8.88	48.0	6.42	36.0	4.46
29		120.0	120.0	27.6	108.0	22.9	96.0	18.6	84.0	14.8	72.0	11.4	60.0	8.59	48.0	6.22	36.0	4.33
27		120.0	120.0	25.8	108.0	21.3	96.0	17.3	84.0	13.8	72.0	10.7	60.0	8.05	48.0	5.85	36.0	4.09
25		120.0	120.0	24.1	108.0	19.9	96.0	16.2	84.0	12.9	72.0	10.0	60.0	7.56	48.0	5.50	36.0	3.86
23		120.0	120.0	23.0	108.0	19.1	96.0	15.5	84.0	12.4	72.0	9.61	60.0	7.25	48.0	5.29	36.0	3.72
21		120.0	120.0	22.5	108.0	18.7	96.0	15.2	84.0	12.1	72.0	9.43	60.0	7.12	48.0	5.21	36.0	3.68
20		120.0	120.0	22.3	108.0	18.5	96.0	15.1	84.0	12.0	72.0	9.35	60.0	7.07	48.0	5.17	36.0	3.65
19		120.0	120.0	22.1	108.0	18.3	96.0	14.9	84.0	11.9	72.0	9.27	60.0	7.02	48.0	5.14	36.0	3.63
17		120.0	120.0	21.7	108.0	18.0	96.0	14.7	84.0	11.7	72.0	9.14	60.0	6.92	48.0	5.07	36.0	3.60
15		120.0	120.0	21.4	108.0	17.8	96.0	14.5	84.0	11.6	72.0	9.03	60.0	6.84	48.0	5.02	36.0	3.57

TC : Total Capacity PI : Power Input
 Indoor air temperature conditions : 27.0 °C dry-bulb / 19.0 °C wet-bulb

Heating			Compressor + Outdoor Fan Power consumption (kW)															
Outdoor Unit		Outdoor Unit 100% Cooling Capacity (kW)	100%		90%		80%		70%		60%		50%		40%		30%	
Dry-Bulb (°C)	Wet-Bulb (°C)		TC	PI	TC	PI	TC	PI	TC	PI	TC	PI	TC	PI	TC	PI	TC	PI
			(kW)	(kW)	(kW)	(kW)	(kW)	(kW)	(kW)	(kW)	(kW)	(kW)	(kW)	(kW)	(kW)	(kW)	(kW)	(kW)
15.0	13.7	135.0	135.0	26.7	121.5	22.6	108.0	18.9	94.5	15.7	81.0	12.9	67.5	10.5	54.0	8.55	40.5	7.05
13.0	11.8	135.0	135.0	27.8	121.5	23.5	108.0	19.6	94.5	16.2	81.0	13.2	67.5	10.7	54.0	8.71	40.5	7.13
11.0	9.8	135.0	135.0	29.1	121.5	24.5	108.0	20.4	94.5	16.8	81.0	13.7	67.5	11.0	54.0	8.89	40.5	7.23
9.0	7.9	135.0	135.0	30.4	121.5	25.6	108.0	21.2	94.5	17.4	81.0	14.1	67.5	11.4	54.0	9.09	40.5	7.33
7.0	6.0	135.0	135.0	31.8	121.5	26.7	108.0	22.1	94.5	18.1	81.0	14.6	67.5	11.7	54.0	9.30	40.5	7.44
5.0	4.1	130.7	130.7	31.6	117.6	26.5	104.5	22.0	91.5	18.0	78.4	14.5	65.3	11.6	52.3	9.24	39.2	7.40
3.0	2.2	126.3	126.3	31.4	113.7	26.4	101.0	21.9	88.4	17.9	75.8	14.5	63.2	11.6	50.5	9.19	37.9	7.36
0.0	-0.7	119.7	119.7	31.2	107.7	26.2	95.7	21.7	83.8	17.7	71.8	14.3	59.8	11.5	47.9	9.11	35.9	7.29
-3.0	-3.7	112.8	112.8	30.9	101.5	25.9	90.3	21.5	79.0	17.6	67.7	14.2	56.4	11.4	45.1	9.02	33.8	7.22
-5.0	-5.6	108.5	108.5	30.7	97.6	25.8	86.8	21.4	75.9	17.5	65.1	14.1	54.2	11.3	43.4	8.97	32.5	7.18
-7.0	-7.6	103.9	103.9	30.5	93.5	25.6	83.1	21.2	72.7	17.4	62.4	14.0	52.0	11.2	41.6	8.92	31.2	7.14
-10	-10.5	97.3	97.3	30.2	87.6	25.4	77.8	21.0	68.1	17.2	58.4	13.9	48.6	11.1	38.9	8.84	29.2	7.07
-14.5	-15.0	87.0	87.0	29.8	78.3	25.0	69.6	20.7	60.9	17.0	52.2	13.7	43.5	11.0	34.8	8.71	26.1	6.97

TC : Total Capacity PI : Power Input
 Indoor air temperature conditions : 20.0 °C dry-bulb



MMY-AP4426HT7P (44HP, 125kW system)

Cooling			Compressor + Outdoor Fan Power consumption (kW)															
Outdoor Unit Dry-Bulb (°C)		Outdoor Unit 100% Cooling Capacity (kW)	100%		90%		80%		70%		60%		50%		40%		30%	
Dry-Bulb (°C)	Wet-Bulb (°C)		TC	PI	TC	PI	TC	PI	TC	PI	TC	PI	TC	PI	TC	PI	TC	PI
			(kW)	(kW)	(kW)	(kW)	(kW)	(kW)	(kW)	(kW)	(kW)	(kW)	(kW)	(kW)	(kW)	(kW)	(kW)	(kW)
40		116.3	116.3	39.5	104.7	32.6	93.1	26.4	81.4	20.8	69.8	16.0	58.2	11.9	46.5	8.48	34.9	5.76
39		118.2	118.2	39.0	106.4	32.1	94.6	26.0	82.7	20.5	70.9	15.8	59.1	11.7	47.3	8.35	35.5	5.67
37		121.7	121.7	37.8	109.5	31.2	97.4	25.2	85.2	19.9	73.0	15.3	60.9	11.4	48.7	8.10	36.5	5.50
35		125.0	125.0	36.6	112.5	30.2	100.0	24.4	87.5	19.3	75.0	14.8	62.5	11.0	50.0	7.84	37.5	5.33
33		125.0	125.0	33.9	112.5	28.0	100.0	22.6	87.5	17.9	75.0	13.8	62.5	10.3	50.0	7.33	37.5	5.00
31		125.0	125.0	31.5	112.5	26.0	100.0	21.0	87.5	16.7	75.0	12.8	62.5	9.58	50.0	6.87	37.5	4.71
30		125.0	125.0	30.3	112.5	25.1	100.0	20.3	87.5	16.1	75.0	12.4	62.5	9.26	50.0	6.65	37.5	4.57
29		125.0	125.0	29.3	112.5	24.2	100.0	19.6	87.5	15.5	75.0	12.0	62.5	8.96	50.0	6.44	37.5	4.44
27		125.0	125.0	27.3	112.5	22.6	100.0	18.3	87.5	14.5	75.0	11.2	62.5	8.40	50.0	6.05	37.5	4.18
25		125.0	125.0	25.5	112.5	21.1	100.0	17.1	87.5	13.6	75.0	10.5	62.5	7.88	50.0	5.69	37.5	3.95
23		125.0	125.0	24.4	112.5	20.2	100.0	16.4	87.5	13.0	75.0	10.1	62.5	7.55	50.0	5.47	37.5	3.80
21		125.0	125.0	23.8	112.5	19.7	100.0	16.0	87.5	12.7	75.0	9.87	62.5	7.42	50.0	5.38	37.5	3.75
20		125.0	125.0	23.6	112.5	19.5	100.0	15.9	87.5	12.6	75.0	9.79	62.5	7.36	50.0	5.34	37.5	3.73
19		125.0	125.0	23.4	112.5	19.4	100.0	15.7	87.5	12.5	75.0	9.71	62.5	7.30	50.0	5.30	37.5	3.71
17		125.0	125.0	23.0	112.5	19.1	100.0	15.5	87.5	12.3	75.0	9.57	62.5	7.20	50.0	5.24	37.5	3.67
15		125.0	125.0	22.7	112.5	18.8	100.0	15.3	87.5	12.2	75.0	9.45	62.5	7.12	50.0	5.18	37.5	3.64

TC : Total Capacity PI : Power Input
 Indoor air temperature conditions : 27.0 °C dry-bulb / 19.0 °C wet-bulb

Heating			Compressor + Outdoor Fan Power consumption (kW)															
Outdoor Unit		Outdoor Unit 100% Cooling Capacity (kW)	100%		90%		80%		70%		60%		50%		40%		30%	
Dry-Bulb (°C)	Wet-Bulb (°C)		TC	PI	TC	PI	TC	PI	TC	PI	TC	PI	TC	PI	TC	PI	TC	PI
			(kW)	(kW)	(kW)	(kW)	(kW)	(kW)	(kW)	(kW)	(kW)	(kW)	(kW)	(kW)	(kW)	(kW)	(kW)	(kW)
15.0	13.7	140.0	140.0	28.3	126.0	23.9	112.0	20.0	98.0	16.5	84.0	13.5	70.0	11.0	56.0	8.94	42.0	7.34
13.0	11.8	140.0	140.0	29.5	126.0	24.9	112.0	20.7	98.0	17.1	84.0	13.9	70.0	11.3	56.0	9.11	42.0	7.43
11.0	9.8	140.0	140.0	30.8	126.0	25.9	112.0	21.6	98.0	17.7	84.0	14.4	70.0	11.6	56.0	9.31	42.0	7.53
9.0	7.9	140.0	140.0	32.2	126.0	27.1	112.0	22.5	98.0	18.4	84.0	14.9	70.0	11.9	56.0	9.51	42.0	7.64
7.0	6.0	140.0	140.0	33.7	126.0	28.3	112.0	23.4	98.0	19.1	84.0	15.4	70.0	12.3	56.0	9.74	42.0	7.76
5.0	4.1	135.3	135.3	33.5	121.8	28.1	108.2	23.3	94.7	19.0	81.2	15.3	67.7	12.2	54.1	9.68	40.6	7.71
3.0	2.2	130.6	130.6	33.3	117.6	27.9	104.5	23.1	91.4	18.9	78.4	15.2	65.3	12.1	52.2	9.61	39.2	7.66
0.0	-0.7	123.5	123.5	32.9	111.1	27.6	98.8	22.9	86.4	18.7	74.1	15.1	61.7	12.0	49.4	9.52	37.0	7.59
-3.0	-3.7	116.1	116.1	32.6	104.5	27.3	92.9	22.6	81.3	18.5	69.6	14.9	58.0	11.9	46.4	9.42	34.8	7.51
-5.0	-5.6	111.4	111.4	32.4	100.3	27.2	89.1	22.5	78.0	18.4	66.8	14.8	55.7	11.8	44.6	9.36	33.4	7.46
-7.0	-7.6	106.5	106.5	32.1	95.8	27.0	85.2	22.3	74.5	18.2	63.9	14.7	53.2	11.7	42.6	9.29	31.9	7.41
-10	-10.5	99.3	99.3	31.8	89.4	26.7	79.5	22.1	69.5	18.1	59.6	14.6	49.7	11.6	39.7	9.20	29.8	7.33
-14.5	-15.0	88.2	88.2	31.3	79.4	26.3	70.6	21.7	61.8	17.8	52.9	14.3	44.1	11.4	35.3	9.05	26.5	7.21

TC : Total Capacity PI : Power Input
 Indoor air temperature conditions : 20.0 °C dry-bulb



MMY-AP5426HT7P (54HP, 152kW system)

Cooling			Compressor + Outdoor Fan Power consumption (kW)															
Outdoor Unit Dry-Bulb (°C)		Outdoor Unit 100% Cooling Capacity (kW)	100%		90%		80%		70%		60%		50%		40%		30%	
			TC (kW)	PI (kW)	TC (kW)	PI (kW)	TC (kW)	PI (kW)	TC (kW)	PI (kW)	TC (kW)	PI (kW)	TC (kW)	PI (kW)	TC (kW)	PI (kW)	TC (kW)	PI (kW)
40		141.4	141.4	50.9	127.3	41.6	113.2	33.3	99.0	26.1	84.9	19.8	70.7	14.6	56.6	10.3	42.4	7.11
39		143.7	143.7	50.1	129.3	41.0	115.0	32.9	100.6	25.7	86.2	19.5	71.9	14.4	57.5	10.2	43.1	7.01
37		148.0	148.0	48.6	133.2	39.8	118.4	31.9	103.6	24.9	88.8	18.9	74.0	13.9	59.2	9.88	44.4	6.79
35		152.0	152.0	47.3	136.8	38.5	121.6	30.9	106.4	24.1	91.2	18.4	76.0	13.5	60.8	9.57	45.6	6.58
33		152.0	152.0	43.5	136.8	35.6	121.6	28.6	106.4	22.4	91.2	17.0	76.0	12.6	60.8	8.95	45.6	6.19
31		152.0	152.0	40.3	136.8	33.0	121.6	26.5	106.4	20.8	91.2	15.9	76.0	11.7	60.8	8.38	45.6	5.84
30		152.0	152.0	38.9	136.8	31.8	121.6	25.6	106.4	20.1	91.2	15.3	76.0	11.3	60.8	8.12	45.6	5.67
29		152.0	152.0	37.5	136.8	30.7	121.6	24.7	106.4	19.4	91.2	14.8	76.0	11.0	60.8	7.87	45.6	5.51
27		152.0	152.0	34.9	136.8	28.6	121.6	23.0	106.4	18.1	91.2	13.8	76.0	10.3	60.8	7.39	45.6	5.21
25		152.0	152.0	32.6	136.8	26.7	121.6	21.5	106.4	16.9	91.2	12.9	76.0	9.63	60.8	6.95	45.6	4.92
23		152.0	152.0	31.1	136.8	25.5	121.6	20.5	106.4	16.1	91.2	12.4	76.0	9.23	60.8	6.68	45.6	4.75
21		152.0	152.0	30.4	136.8	24.9	121.6	20.1	106.4	15.8	91.2	12.1	76.0	9.06	60.8	6.58	45.6	4.69
20		152.0	152.0	30.1	136.8	24.7	121.6	19.9	106.4	15.7	91.2	12.0	76.0	8.99	60.8	6.53	45.6	4.67
19		152.0	152.0	29.8	136.8	24.5	121.6	19.7	106.4	15.5	91.2	11.9	76.0	8.92	60.8	6.49	45.6	4.64
17		152.0	152.0	29.3	136.8	24.0	121.6	19.4	106.4	15.3	91.2	11.8	76.0	8.80	60.8	6.41	45.6	4.60
15		152.0	152.0	28.8	136.8	23.7	121.6	19.1	106.4	15.1	91.2	11.6	76.0	8.69	60.8	6.35	45.6	4.56

TC : Total Capacity PI : Power Input
 Indoor air temperature conditions : 27.0 °C dry-bulb / 19.0 °C wet-bulb

Heating			Compressor + Outdoor Fan Power consumption (kW)															
Outdoor Unit		Outdoor Unit 100% Cooling Capacity (kW)	100%		90%		80%		70%		60%		50%		40%		30%	
Dry-Bulb (°C)	Wet-Bulb (°C)		TC (kW)	PI (kW)	TC (kW)	PI (kW)	TC (kW)	PI (kW)	TC (kW)	PI (kW)	TC (kW)	PI (kW)	TC (kW)	PI (kW)	TC (kW)	PI (kW)	TC (kW)	PI (kW)
15.0	13.7	171.0	171.0	37.1	153.9	31.7	136.8	26.7	119.7	22.2	102.6	18.1	85.5	14.5	68.4	11.3	51.3	8.48
13.0	11.8	171.0	171.0	38.6	153.9	32.9	136.8	27.7	119.7	23.0	102.6	18.7	85.5	14.9	68.4	11.5	51.3	8.66
11.0	9.8	171.0	171.0	40.2	153.9	34.2	136.8	28.8	119.7	23.8	102.6	19.3	85.5	15.4	68.4	11.9	51.3	8.87
9.0	7.9	171.0	171.0	41.8	153.9	35.6	136.8	29.9	119.7	24.7	102.6	20.0	85.5	15.8	68.4	12.2	51.3	9.08
7.0	6.0	171.0	171.0	43.6	153.9	37.1	136.8	31.1	119.7	25.6	102.6	20.7	85.5	16.4	68.4	12.6	51.3	9.30
5.0	4.1	165.0	165.0	43.3	148.5	36.8	132.0	30.8	115.5	25.4	99.0	20.6	82.5	16.3	66.0	12.5	49.5	9.24
3.0	2.2	159.1	159.1	43.0	143.2	36.5	127.3	30.6	111.4	25.3	95.4	20.4	79.5	16.1	63.6	12.4	47.7	9.17
0.0	-0.7	150.0	150.0	42.5	135.0	36.1	120.0	30.3	105.0	25.0	90.0	20.2	75.0	16.0	60.0	12.2	45.0	9.07
-3.0	-3.7	140.6	140.6	42.0	126.5	35.7	112.5	29.9	98.4	24.7	84.3	20.0	70.3	15.8	56.2	12.1	42.2	8.97
-5.0	-5.6	134.6	134.6	41.7	121.2	35.4	107.7	29.7	94.2	24.5	80.8	19.8	67.3	15.7	53.8	12.0	40.4	8.90
-7.0	-7.6	128.3	128.3	41.4	115.5	35.2	102.7	29.5	89.8	24.3	77.0	19.7	64.2	15.5	51.3	11.9	38.5	8.83
-10	-10.5	119.2	119.2	40.9	107.3	34.8	95.4	29.1	83.5	24.0	71.5	19.4	59.6	15.4	47.7	11.8	35.8	8.73
-14.5	-15.0	105.1	105.1	40.2	94.6	34.1	84.1	28.6	73.6	23.6	63.1	19.1	52.6	15.1	42.1	11.6	31.5	8.57

TC : Total Capacity PI : Power Input
 Indoor air temperature conditions : 20.0 °C dry-bulb



5-11. Sound pressure level data

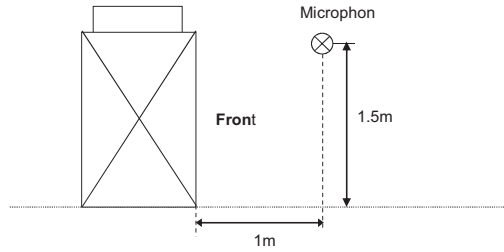

Standard model

MMY-MAP0806HT8P, MMY-MAP0806HT7P

Sound pressure Level (dB(A))	Cooling	Heating
	55.0	56.0

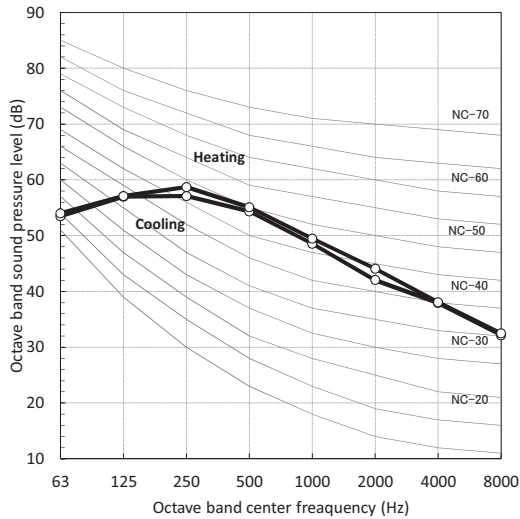

MMY-MAP1006HT8P, MMY-MAP1006HT7P

Sound pressure Level (dB(A))	Cooling	Heating
	57.0	58.0

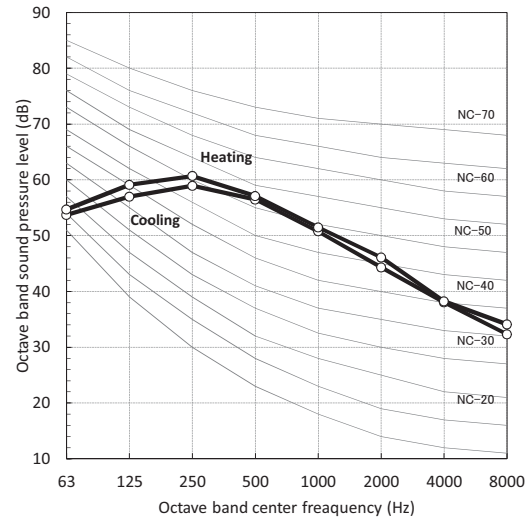

MMY-MAP1206HT8P, MMY-MAP1206HT7P

Sound pressure Level (dB(A))	Cooling	Heating
	59.0	61.0

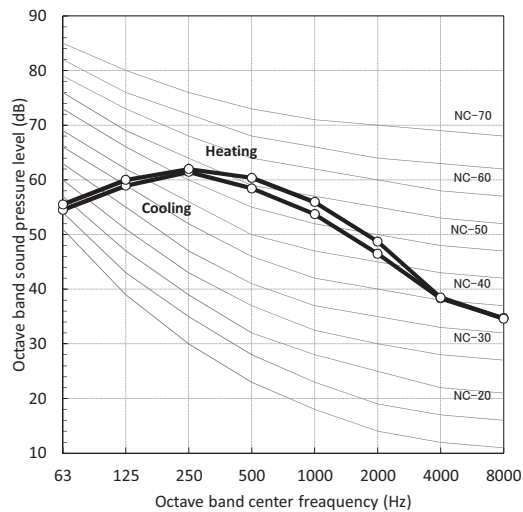

MMY-MAP1406HT8P, MMY-MAP1406HT7P

Sound pressure Level (dB(A))	Cooling	Heating
	60.0	62.0

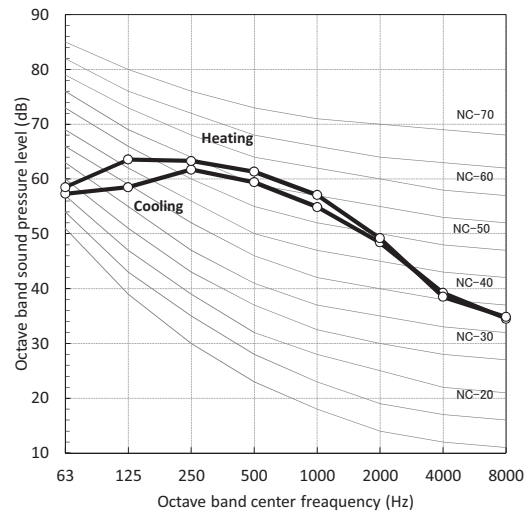



MMY-MAP1604HT8P, MMY-MAP1604HT7P

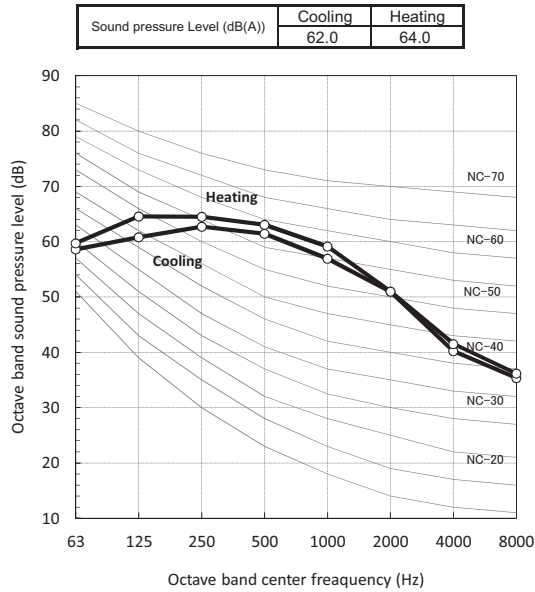

MMY-MAP1806HT8P, MMY-MAP1806HT7P

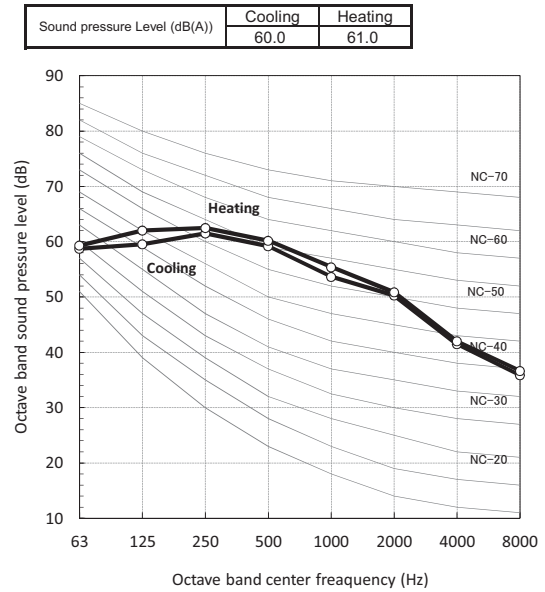

MMY-MAP2006HT8P, MMY-MAP2006HT7P

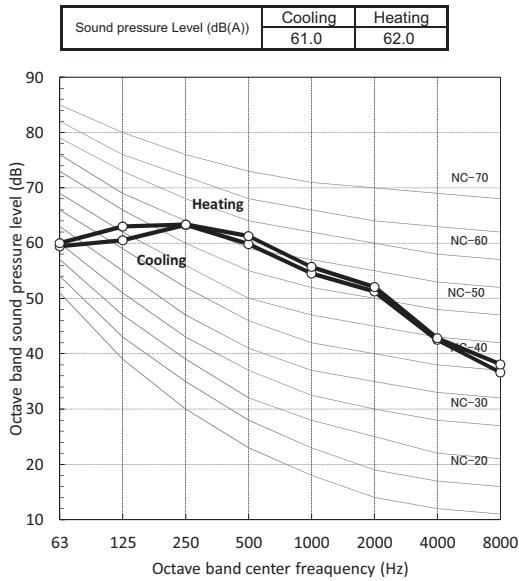

MMY-MAP2206HT8P, MMY-MAP2206HT7P

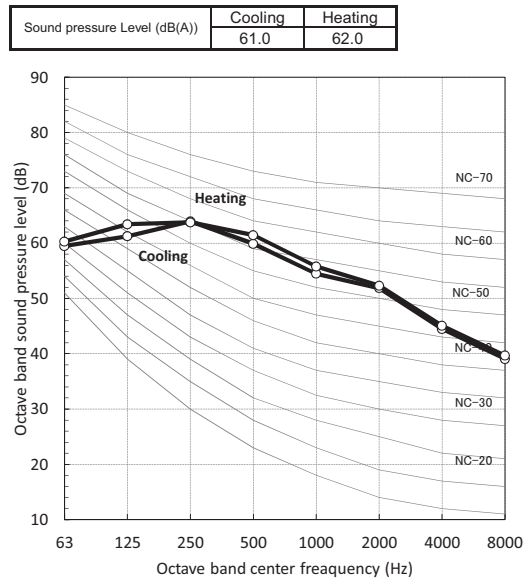



MMY-AP2416HT8P, MMY-AP2416HT7P

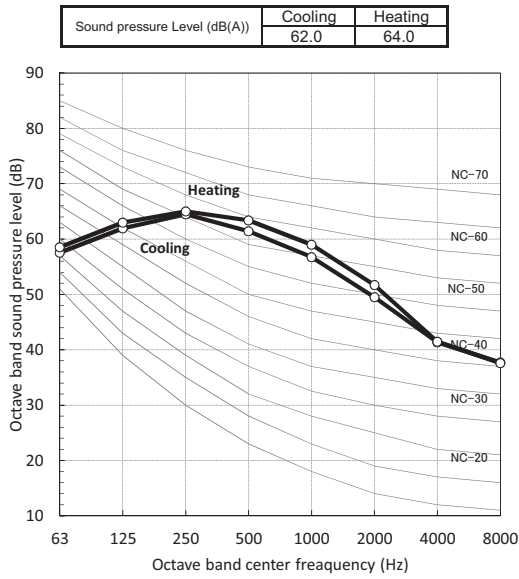

MMY-AP2616HT8P, MMY-AP2616HT7P

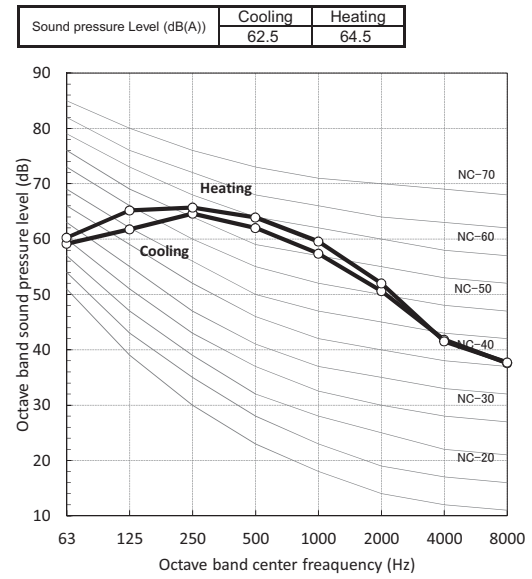

MMY-AP2816HT8P, MMY-AP2816HT7P

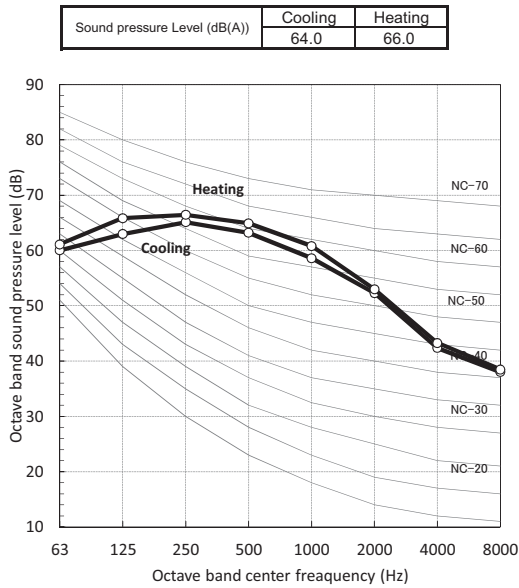

MMY-AP3016HT8P, MMY-AP3016HT7P

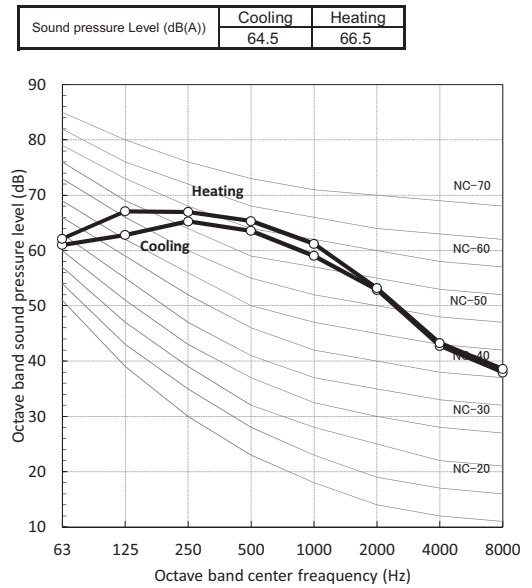



MMY-AP3216HT8P, MMY-AP3216HT7P

Sound pressure Level (dB(A))	Cooling	Heating
	65.0	67.0

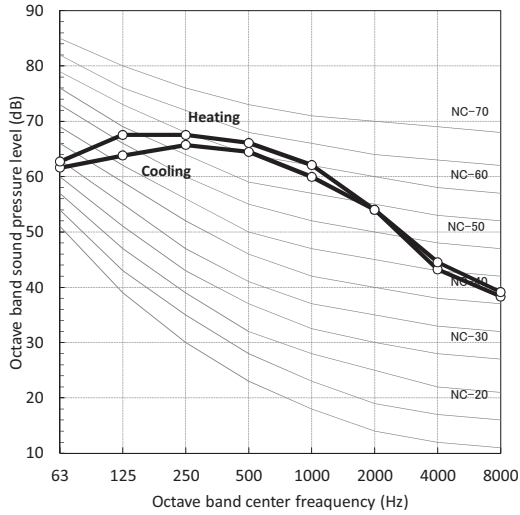

MMY-AP3416HT8P, MMY-AP3416HT7P

Sound pressure Level (dB(A))	Cooling	Heating
	64.5	66.0

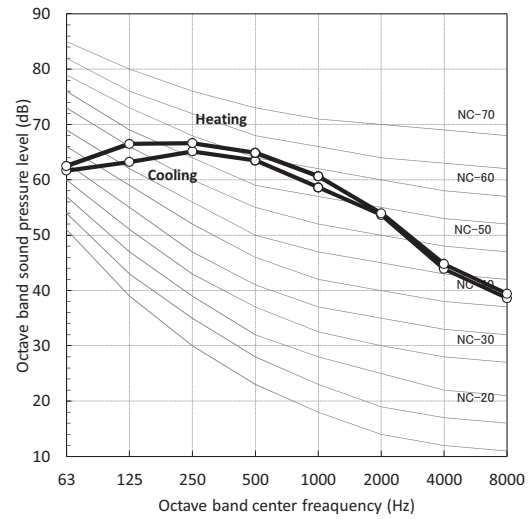

MMY-AP3616HT8P, MMY-AP3616HT7P

Sound pressure Level (dB(A))	Cooling	Heating
	64.5	66.5

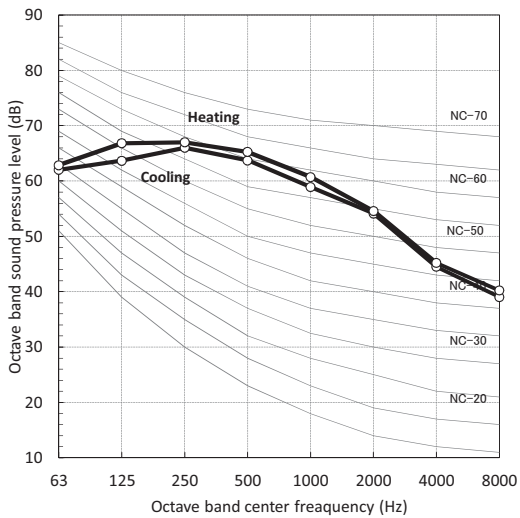

MMY-AP3816HT8P, MMY-AP3816HT7P

Sound pressure Level (dB(A))	Cooling	Heating
	64.5	66.5

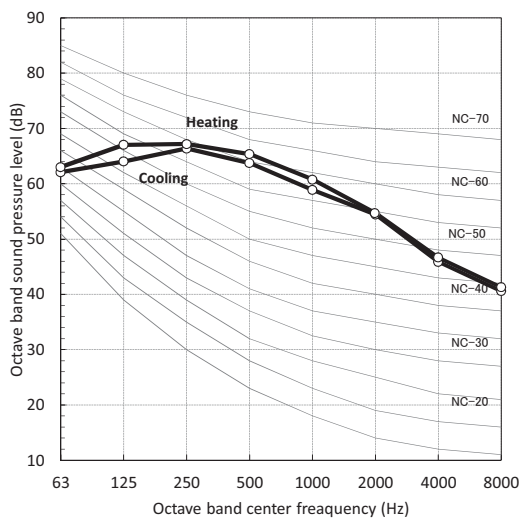



MMY-AP4016HT8P, MMY-AP4016HT7P

Sound pressure Level (dB(A))	Cooling	Heating
	64.0	65.0

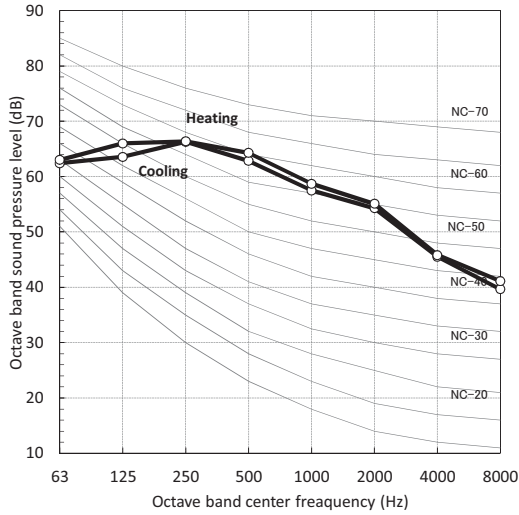

MMY-AP4216HT8P, MMY-AP4216HT7P

Sound pressure Level (dB(A))	Cooling	Heating
	64.0	65.0

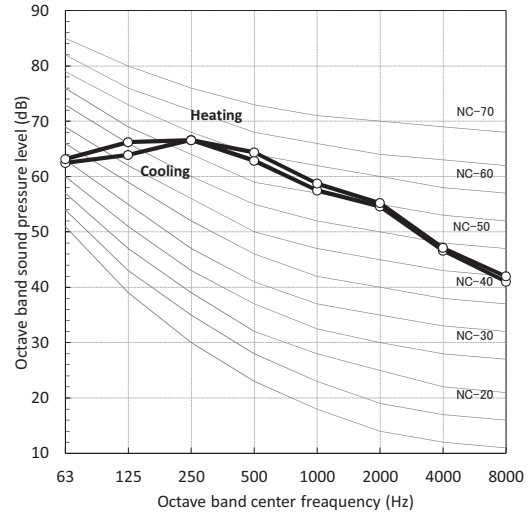

MMY-AP4416HT8P, MMY-AP4416HT7P

Sound pressure Level (dB(A))	Cooling	Heating
	64.0	65.0

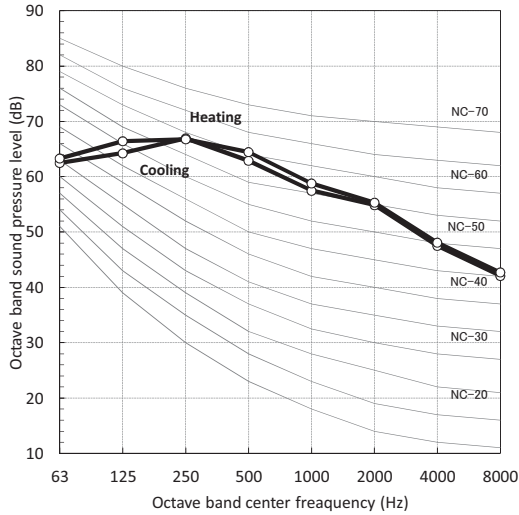

MMY-AP4616HT8P, MMY-AP4616HT7P

Sound pressure Level (dB(A))	Cooling	Heating
	66.5	68.5

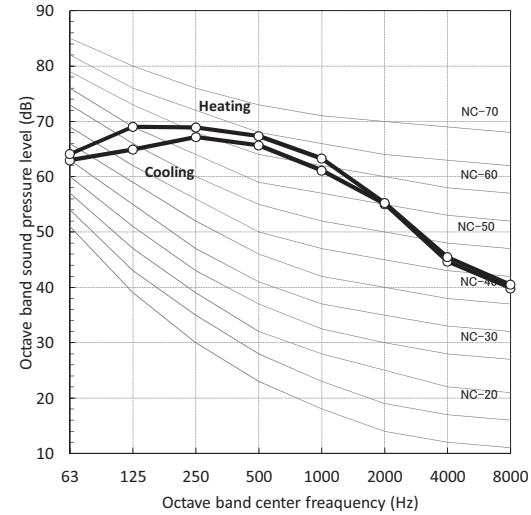



MMY-AP4816HT8P, MMY-AP4816HT7P

Sound pressure Level (dB(A))	Cooling	Heating
	67.0	69.0

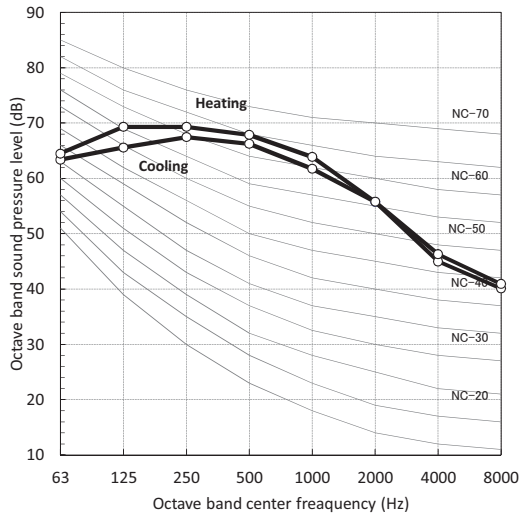

MMY-AP5016HT8P, MMY-AP5016HT7P

Sound pressure Level (dB(A))	Cooling	Heating
	66.5	68.0

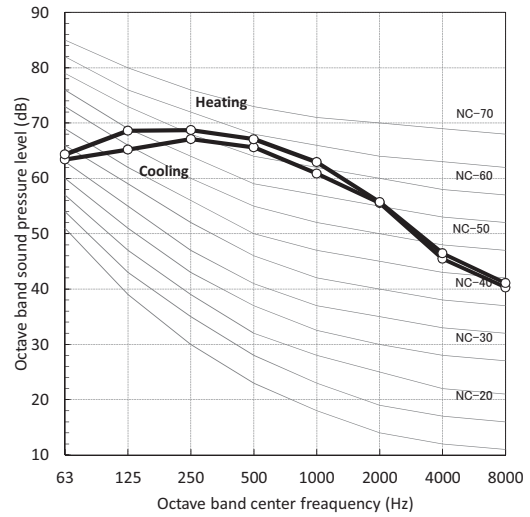

MMY-AP5216HT8P, MMY-AP5216HT7P

Sound pressure Level (dB(A))	Cooling	Heating
	66.5	68.5

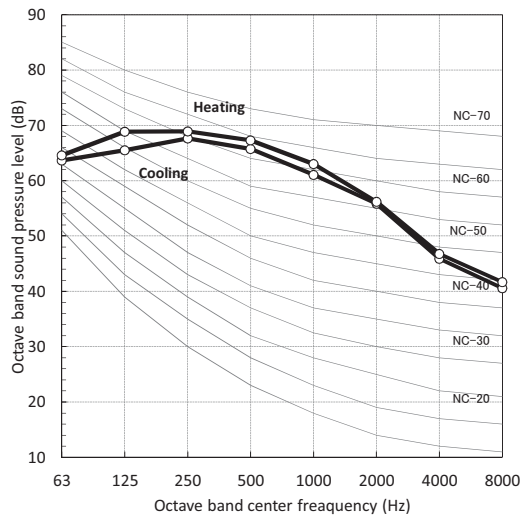

MMY-AP5416HT8P, MMY-AP5416HT7P

Sound pressure Level (dB(A))	Cooling	Heating
	66.5	68.5

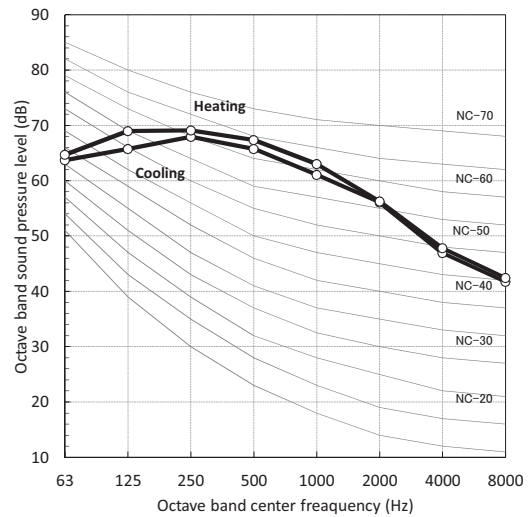



MMY-AP5616HT8P, MMY-AP5616HT7P

Sound pressure Level (dB(A))	Cooling	Heating
	66.5	67.5

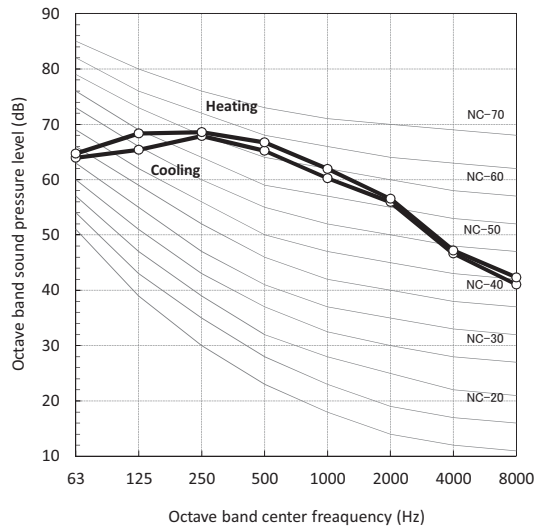

MMY-AP5816HT8P, MMY-AP5816HT7P

Sound pressure Level (dB(A))	Cooling	Heating
	66.5	67.5

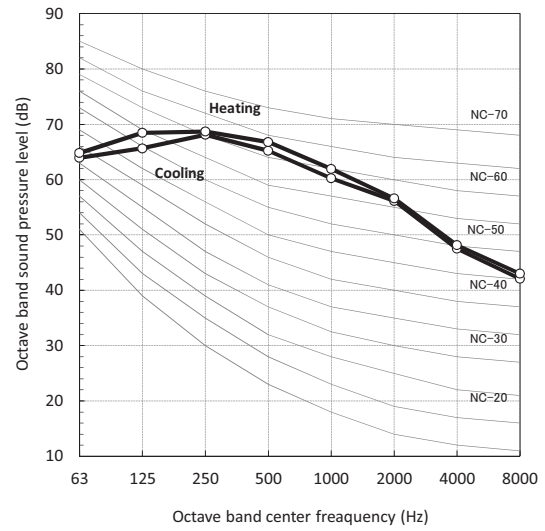

MMY-AP6016HT8P, MMY-AP6016HT7P

Sound pressure Level (dB(A))	Cooling	Heating
	66.5	67.5

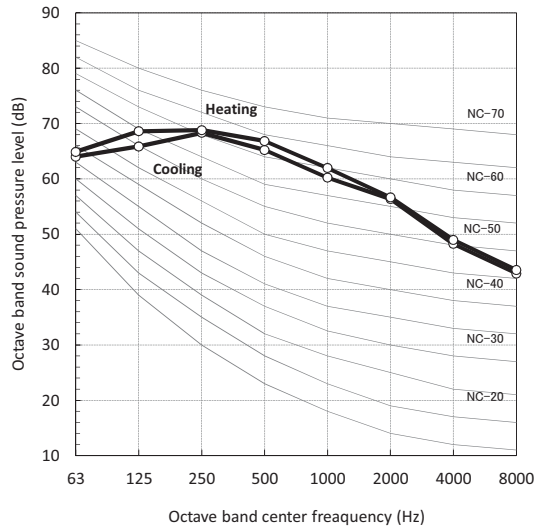



High efficiency model

MMY-AP2026HT8P, MMY-AP2026HT7P

Sound pressure Level (dB(A))	Cooling	Heating
	60.0	61.0

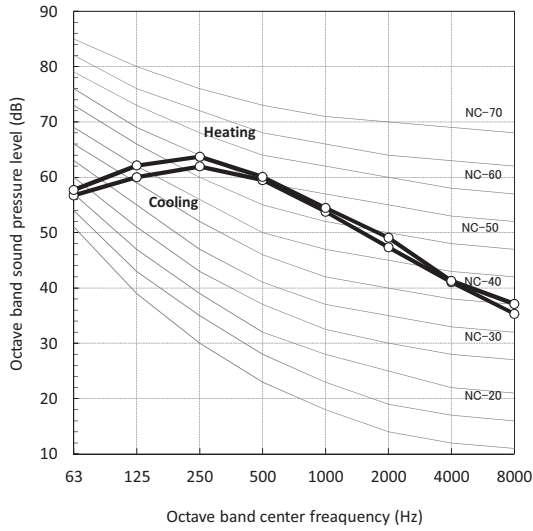

MMY-AP2226HT8P, MMY-AP2226HT7P

Sound pressure Level (dB(A))	Cooling	Heating
	61.5	63.0

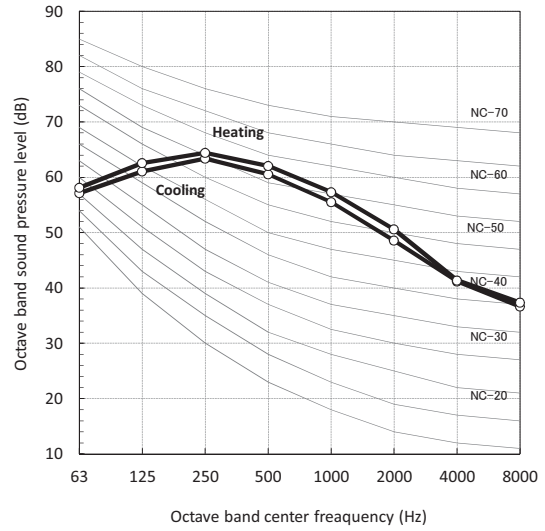

MMY-AP3626HT8P, MMY-AP3626HT7P

Sound pressure Level (dB(A))	Cooling	Heating
	64.0	66.0

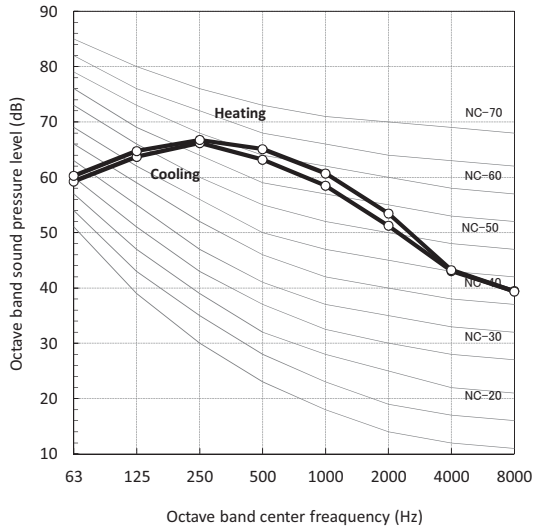

MMY-AP3826HT8P, MMY-AP3826HT7P

Sound pressure Level (dB(A))	Cooling	Heating
	64.5	66.5

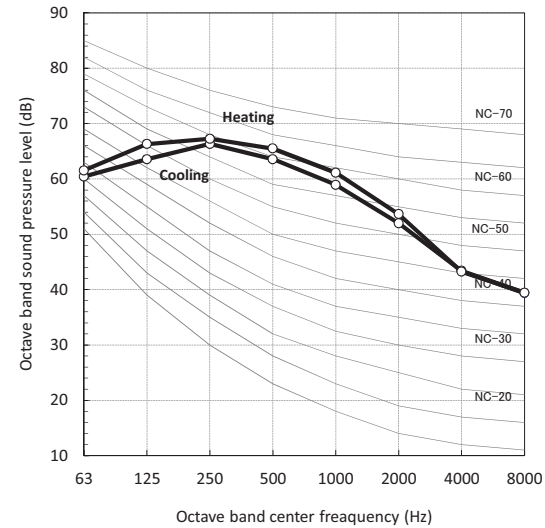



MMY-AP4026HT8P, MMY-AP3826HT7P

Sound pressure Level (dB(A))	Cooling	Heating
	64.5	66.5

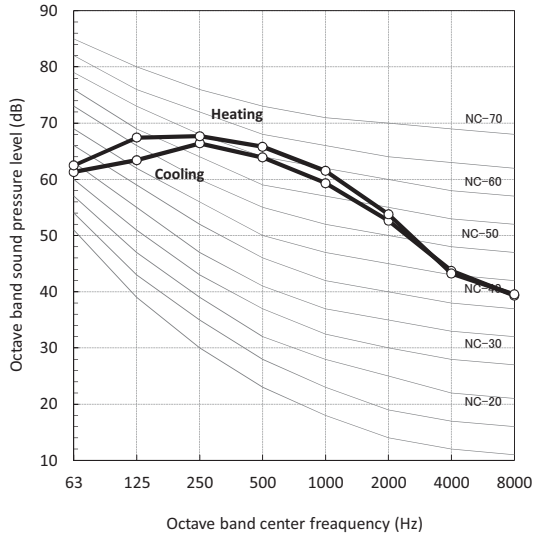

MMY-AP4226HT8P, MMY-AP4226HT7P

Sound pressure Level (dB(A))	Cooling	Heating
	65.0	67.0

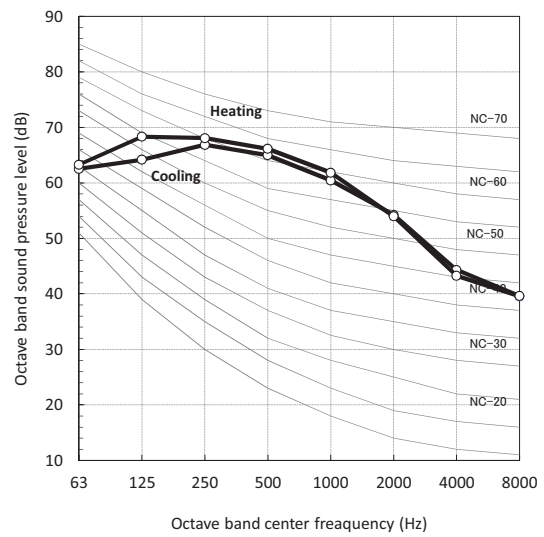

MMY-AP4426HT8P, MMY-AP4426HT7P

Sound pressure Level (dB(A))	Cooling	Heating
	65.5	67.5

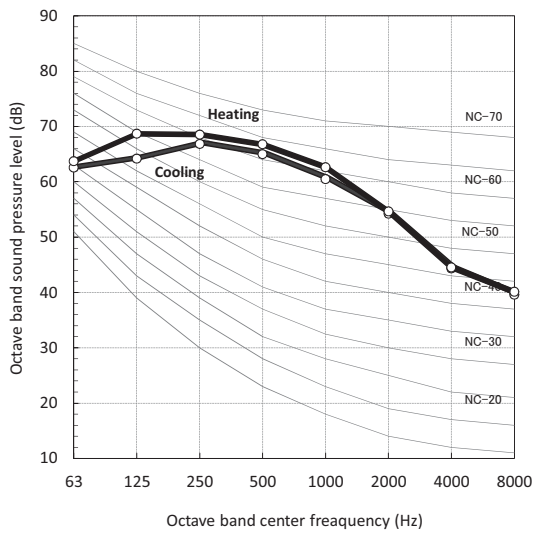

MMY-AP5426HT8P, MMY-AP5426HT7P

Sound pressure Level (dB(A))	Cooling	Heating
	65.5	67.0

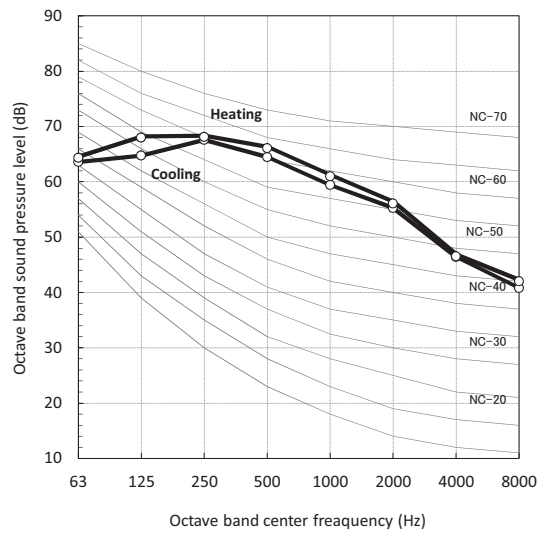

Appendix



4-way Air Discharge Cassette Type (MMU-AP ___4HP-E)

TC : Total capacity [kW] SHC : Sensible capacity [kW]

unit size	outdoor air temp. °CDB	indoor air temp.													
		14°CWB		16°CWB		18°CWB		19°CWB		20°CWB		22°CWB		24°CWB	
		20°CDB	23°CDB	26°CDB	27°CDB	28°CDB	30°CDB	32°CDB	TC	SHC	TC	SHC	TC	SHC	TC
009	10	2.3	2.0	2.5	2.2	2.7	2.3	2.8	2.3	2.9	2.3	3.1	2.3	3.2	2.2
	12	2.3	2.0	2.5	2.2	2.7	2.3	2.8	2.3	2.9	2.3	3.1	2.3	3.2	2.2
	14	2.3	2.0	2.5	2.2	2.7	2.3	2.8	2.3	2.9	2.3	3.1	2.3	3.2	2.2
	16	2.3	2.0	2.5	2.2	2.7	2.3	2.8	2.3	2.9	2.3	3.1	2.3	3.2	2.2
	18	2.3	2.0	2.5	2.2	2.7	2.3	2.8	2.3	2.9	2.3	3.1	2.3	3.2	2.2
	20	2.3	2.0	2.5	2.2	2.7	2.3	2.8	2.3	2.9	2.3	3.1	2.3	3.2	2.2
	21	2.3	2.0	2.5	2.2	2.7	2.3	2.8	2.3	2.9	2.3	3.1	2.3	3.2	2.2
	23	2.3	2.0	2.5	2.2	2.7	2.3	2.8	2.3	2.9	2.3	3.1	2.3	3.2	2.2
	25	2.3	2.0	2.5	2.2	2.7	2.3	2.8	2.3	2.9	2.3	3.1	2.3	3.2	2.2
	27	2.3	2.0	2.5	2.2	2.7	2.3	2.8	2.3	2.9	2.3	3.1	2.3	3.2	2.2
	29	2.3	2.0	2.5	2.2	2.7	2.3	2.8	2.3	2.9	2.3	3.1	2.3	3.2	2.2
	31	2.3	2.0	2.5	2.2	2.7	2.3	2.8	2.3	2.9	2.3	3.1	2.3	3.2	2.2
	33	2.3	2.0	2.5	2.2	2.7	2.3	2.8	2.3	2.9	2.3	3.1	2.3	3.2	2.2
	35	2.3	2.0	2.5	2.2	2.7	2.3	2.8	2.3	2.9	2.3	3.1	2.3	3.2	2.2
	37	2.2	2.0	2.5	2.1	2.6	2.2	2.7	2.2	2.8	2.2	3.0	2.2	3.1	2.2
	39	2.1	1.9	2.4	2.0	2.5	2.1	2.6	2.1	2.7	2.1	2.8	2.1	3.0	2.1
	40	2.1	1.8	2.3	2.0	2.4	2.1	2.5	2.1	2.6	2.1	2.7	2.1	2.9	2.0
42	1.9	1.7	2.1	1.8	2.3	1.9	2.3	1.9	2.4	1.9	2.6	1.9	2.7	1.9	
44	1.8	1.6	1.9	1.7	2.1	1.8	2.1	1.8	2.2	1.8	2.3	1.7	2.4	1.7	
46	1.5	1.4	1.7	1.5	1.8	1.6	1.9	1.5	1.9	1.5	2.1	1.5	2.1	1.5	
012	10	3.0	2.6	3.3	2.7	3.5	2.9	3.6	2.9	3.7	2.9	3.9	2.9	4.1	2.8
	12	3.0	2.6	3.3	2.7	3.5	2.9	3.6	2.9	3.7	2.9	3.9	2.9	4.1	2.8
	14	3.0	2.6	3.3	2.7	3.5	2.9	3.6	2.9	3.7	2.9	3.9	2.9	4.1	2.8
	16	3.0	2.6	3.3	2.7	3.5	2.9	3.6	2.9	3.7	2.9	3.9	2.9	4.1	2.8
	18	3.0	2.6	3.3	2.7	3.5	2.9	3.6	2.9	3.7	2.9	3.9	2.9	4.1	2.8
	20	3.0	2.6	3.3	2.7	3.5	2.9	3.6	2.9	3.7	2.9	3.9	2.9	4.1	2.8
	21	3.0	2.6	3.3	2.7	3.5	2.9	3.6	2.9	3.7	2.9	3.9	2.9	4.1	2.8
	23	3.0	2.6	3.3	2.7	3.5	2.9	3.6	2.9	3.7	2.9	3.9	2.9	4.1	2.8
	25	3.0	2.6	3.3	2.7	3.5	2.9	3.6	2.9	3.7	2.9	3.9	2.9	4.1	2.8
	27	3.0	2.6	3.3	2.7	3.5	2.9	3.6	2.9	3.7	2.9	3.9	2.9	4.1	2.8
	29	3.0	2.6	3.3	2.7	3.5	2.9	3.6	2.9	3.7	2.9	3.9	2.9	4.1	2.8
	31	3.0	2.6	3.3	2.7	3.5	2.9	3.6	2.9	3.7	2.9	3.9	2.9	4.1	2.8
	33	3.0	2.6	3.3	2.7	3.5	2.9	3.6	2.9	3.7	2.9	3.9	2.9	4.1	2.8
	35	3.0	2.6	3.3	2.7	3.5	2.9	3.6	2.9	3.7	2.9	3.9	2.9	4.1	2.8
	37	2.9	2.5	3.2	2.7	3.4	2.8	3.5	2.8	3.6	2.8	3.8	2.8	4.0	2.7
	39	2.7	2.4	3.0	2.5	3.2	2.7	3.3	2.7	3.4	2.7	3.6	2.7	3.8	2.6
	40	2.7	2.3	2.9	2.5	3.1	2.6	3.2	2.6	3.3	2.6	3.5	2.6	3.7	2.5
42	2.5	2.2	2.7	2.3	2.9	2.4	3.0	2.4	3.1	2.4	3.3	2.4	3.4	2.3	
44	2.3	2.0	2.5	2.1	2.7	2.2	2.7	2.2	2.8	2.2	3.0	2.2	3.1	2.1	
46	2.0	1.7	2.2	1.8	2.3	2.0	2.4	2.0	2.5	1.9	2.6	1.9	2.8	1.9	
015	10	3.7	3.2	4.1	3.4	4.4	3.6	4.5	3.6	4.6	3.6	4.9	3.6	5.1	3.5
	12	3.7	3.2	4.1	3.4	4.4	3.6	4.5	3.6	4.6	3.6	4.9	3.6	5.1	3.5
	14	3.7	3.2	4.1	3.4	4.4	3.6	4.5	3.6	4.6	3.6	4.9	3.6	5.1	3.5
	16	3.7	3.2	4.1	3.4	4.4	3.6	4.5	3.6	4.6	3.6	4.9	3.6	5.1	3.5
	18	3.7	3.2	4.1	3.4	4.4	3.6	4.5	3.6	4.6	3.6	4.9	3.6	5.1	3.5
	20	3.7	3.2	4.1	3.4	4.4	3.6	4.5	3.6	4.6	3.6	4.9	3.6	5.1	3.5
	21	3.7	3.2	4.1	3.4	4.4	3.6	4.5	3.6	4.6	3.6	4.9	3.6	5.1	3.5
	23	3.7	3.2	4.1	3.4	4.4	3.6	4.5	3.6	4.6	3.6	4.9	3.6	5.1	3.5
	25	3.7	3.2	4.1	3.4	4.4	3.6	4.5	3.6	4.6	3.6	4.9	3.6	5.1	3.5
	27	3.7	3.2	4.1	3.4	4.4	3.6	4.5	3.6	4.6	3.6	4.9	3.6	5.1	3.5
	29	3.7	3.2	4.1	3.4	4.4	3.6	4.5	3.6	4.6	3.6	4.9	3.6	5.1	3.5
	31	3.7	3.2	4.1	3.4	4.4	3.6	4.5	3.6	4.6	3.6	4.9	3.6	5.1	3.5
	33	3.7	3.2	4.1	3.4	4.4	3.6	4.5	3.6	4.6	3.6	4.9	3.6	5.1	3.5
	35	3.7	3.2	4.1	3.4	4.4	3.6	4.5	3.6	4.6	3.6	4.9	3.6	5.1	3.5
	37	3.6	3.1	4.0	3.3	4.2	3.5	4.4	3.5	4.5	3.5	4.8	3.5	5.0	3.4
	39	3.4	3.0	3.8	3.2	4.0	3.3	4.2	3.3	4.3	3.3	4.5	3.3	4.8	3.2
	40	3.3	2.9	3.7	3.1	3.9	3.2	4.1	3.2	4.2	3.2	4.4	3.2	4.6	3.1
42	3.1	2.7	3.4	2.8	3.7	3.0	3.8	3.0	3.9	3.0	4.1	3.0	4.3	2.9	
44	2.8	2.4	3.1	2.6	3.3	2.7	3.4	2.7	3.5	2.7	3.7	2.7	3.9	2.7	
46	2.5	2.1	2.7	2.3	2.9	2.4	3.0	2.4	3.1	2.4	3.3	2.4	3.4	2.3	



4-way Air Discharge Cassette Type (MMU-AP ___4HP-E)

TC : Total capacity [kW] SHC : Sensible capacity [kW]

unit size	outdoor air temp. °CDB	indoor air temp.													
		14°CWB		16°CWB		18°CWB		19°CWB		20°CWB		22°CWB		24°CWB	
		20°CDB		23°CDB		26°CDB		27°CDB		28°CDB		30°CDB		32°CDB	
		TC	SHC	TC	SHC	TC	SHC	TC	SHC	TC	SHC	TC	SHC	TC	SHC
018	10	4.6	3.9	5.1	4.2	5.4	4.4	5.6	4.4	5.8	4.4	6.1	4.4	6.4	4.3
	12	4.6	3.9	5.1	4.2	5.4	4.4	5.6	4.4	5.8	4.4	6.1	4.4	6.4	4.3
	14	4.6	3.9	5.1	4.2	5.4	4.4	5.6	4.4	5.8	4.4	6.1	4.4	6.4	4.3
	16	4.6	3.9	5.1	4.2	5.4	4.4	5.6	4.4	5.8	4.4	6.1	4.4	6.4	4.3
	18	4.6	3.9	5.1	4.2	5.4	4.4	5.6	4.4	5.8	4.4	6.1	4.4	6.4	4.3
	20	4.6	3.9	5.1	4.2	5.4	4.4	5.6	4.4	5.8	4.4	6.1	4.4	6.4	4.3
	21	4.6	3.9	5.1	4.2	5.4	4.4	5.6	4.4	5.8	4.4	6.1	4.4	6.4	4.3
	23	4.6	3.9	5.1	4.2	5.4	4.4	5.6	4.4	5.8	4.4	6.1	4.4	6.4	4.3
	25	4.6	3.9	5.1	4.2	5.4	4.4	5.6	4.4	5.8	4.4	6.1	4.4	6.4	4.3
	27	4.6	3.9	5.1	4.2	5.4	4.4	5.6	4.4	5.8	4.4	6.1	4.4	6.4	4.3
	29	4.6	3.9	5.1	4.2	5.4	4.4	5.6	4.4	5.8	4.4	6.1	4.4	6.4	4.3
	31	4.6	3.9	5.1	4.2	5.4	4.4	5.6	4.4	5.8	4.4	6.1	4.4	6.4	4.3
	33	4.6	3.9	5.1	4.2	5.4	4.4	5.6	4.4	5.8	4.4	6.1	4.4	6.4	4.3
	35	4.6	3.9	5.1	4.2	5.4	4.4	5.6	4.4	5.8	4.4	6.1	4.4	6.4	4.3
	37	4.5	3.8	4.9	4.0	5.3	4.3	5.4	4.3	5.6	4.3	5.9	4.2	6.2	4.1
	39	4.3	3.6	4.7	3.9	5.0	4.1	5.2	4.1	5.3	4.1	5.7	4.0	5.9	3.9
40	4.1	3.5	4.6	3.7	4.9	4.0	5.0	4.0	5.2	4.0	5.5	3.9	5.7	3.8	
42	3.8	3.3	4.3	3.5	4.5	3.7	4.7	3.7	4.8	3.7	5.1	3.6	5.3	3.6	
44	3.5	3.0	3.9	3.2	4.1	3.4	4.3	3.3	4.4	3.3	4.6	3.3	4.9	3.2	
46	3.1	2.6	3.4	2.8	3.7	3.0	3.8	3.0	3.9	3.0	4.1	2.9	4.3	2.9	
024	10	5.8	4.9	6.4	5.2	6.9	5.5	7.1	5.5	7.3	5.5	7.7	5.4	8.1	5.3
	12	5.8	4.9	6.4	5.2	6.9	5.5	7.1	5.5	7.3	5.5	7.7	5.4	8.1	5.3
	14	5.8	4.9	6.4	5.2	6.9	5.5	7.1	5.5	7.3	5.5	7.7	5.4	8.1	5.3
	16	5.8	4.9	6.4	5.2	6.9	5.5	7.1	5.5	7.3	5.5	7.7	5.4	8.1	5.3
	18	5.8	4.9	6.4	5.2	6.9	5.5	7.1	5.5	7.3	5.5	7.7	5.4	8.1	5.3
	20	5.8	4.9	6.4	5.2	6.9	5.5	7.1	5.5	7.3	5.5	7.7	5.4	8.1	5.3
	21	5.8	4.9	6.4	5.2	6.9	5.5	7.1	5.5	7.3	5.5	7.7	5.4	8.1	5.3
	23	5.8	4.9	6.4	5.2	6.9	5.5	7.1	5.5	7.3	5.5	7.7	5.4	8.1	5.3
	25	5.8	4.9	6.4	5.2	6.9	5.5	7.1	5.5	7.3	5.5	7.7	5.4	8.1	5.3
	27	5.8	4.9	6.4	5.2	6.9	5.5	7.1	5.5	7.3	5.5	7.7	5.4	8.1	5.3
	29	5.8	4.9	6.4	5.2	6.9	5.5	7.1	5.5	7.3	5.5	7.7	5.4	8.1	5.3
	31	5.8	4.9	6.4	5.2	6.9	5.5	7.1	5.5	7.3	5.5	7.7	5.4	8.1	5.3
	33	5.8	4.9	6.4	5.2	6.9	5.5	7.1	5.5	7.3	5.5	7.7	5.4	8.1	5.3
	35	5.8	4.9	6.4	5.2	6.9	5.5	7.1	5.5	7.3	5.5	7.7	5.4	8.1	5.3
	37	5.7	4.7	6.3	5.0	6.7	5.4	6.9	5.3	7.1	5.3	7.5	5.3	7.9	5.2
	39	5.4	4.5	6.0	4.8	6.4	5.1	6.6	5.1	6.8	5.1	7.2	5.0	7.5	4.9
40	5.2	4.4	5.8	4.7	6.2	5.0	6.4	5.0	6.6	5.0	7.0	4.9	7.3	4.8	
42	4.9	4.1	5.4	4.3	5.8	4.6	5.9	4.6	6.1	4.6	6.5	4.6	6.8	4.5	
44	4.4	3.7	4.9	4.0	5.2	4.2	5.4	4.2	5.6	4.2	5.9	4.1	6.2	4.1	
46	3.9	3.3	4.3	3.5	4.6	3.7	4.8	3.7	4.9	3.7	5.2	3.7	5.4	3.6	
027	10	6.6	5.3	7.3	5.7	7.8	6.0	8.0	6.0	8.2	6.0	8.7	5.9	9.1	5.8
	12	6.6	5.3	7.3	5.7	7.8	6.0	8.0	6.0	8.2	6.0	8.7	5.9	9.1	5.8
	14	6.6	5.3	7.3	5.7	7.8	6.0	8.0	6.0	8.2	6.0	8.7	5.9	9.1	5.8
	16	6.6	5.3	7.3	5.7	7.8	6.0	8.0	6.0	8.2	6.0	8.7	5.9	9.1	5.8
	18	6.6	5.3	7.3	5.7	7.8	6.0	8.0	6.0	8.2	6.0	8.7	5.9	9.1	5.8
	20	6.6	5.3	7.3	5.7	7.8	6.0	8.0	6.0	8.2	6.0	8.7	5.9	9.1	5.8
	21	6.6	5.3	7.3	5.7	7.8	6.0	8.0	6.0	8.2	6.0	8.7	5.9	9.1	5.8
	23	6.6	5.3	7.3	5.7	7.8	6.0	8.0	6.0	8.2	6.0	8.7	5.9	9.1	5.8
	25	6.6	5.3	7.3	5.7	7.8	6.0	8.0	6.0	8.2	6.0	8.7	5.9	9.1	5.8
	27	6.6	5.3	7.3	5.7	7.8	6.0	8.0	6.0	8.2	6.0	8.7	5.9	9.1	5.8
	29	6.6	5.3	7.3	5.7	7.8	6.0	8.0	6.0	8.2	6.0	8.7	5.9	9.1	5.8
	31	6.6	5.3	7.3	5.7	7.8	6.0	8.0	6.0	8.2	6.0	8.7	5.9	9.1	5.8
	33	6.6	5.3	7.3	5.7	7.8	6.0	8.0	6.0	8.2	6.0	8.7	5.9	9.1	5.8
	35	6.6	5.3	7.3	5.7	7.8	6.0	8.0	6.0	8.2	6.0	8.7	5.9	9.1	5.8
	37	6.4	5.2	7.0	5.5	7.5	5.8	7.8	5.8	8.0	5.8	8.5	5.8	8.8	5.6
	39	6.1	4.9	6.7	5.3	7.2	5.6	7.4	5.6	7.6	5.6	8.1	5.5	8.5	5.4
40	5.9	4.8	6.5	5.1	7.0	5.4	7.2	5.4	7.4	5.4	7.8	5.4	8.2	5.2	
42	5.5	4.5	6.1	4.7	6.5	5.0	6.7	5.0	6.9	5.0	7.3	5.0	7.6	4.9	
44	5.0	4.1	5.5	4.3	5.9	4.6	6.1	4.6	6.3	4.6	6.6	4.5	6.9	4.4	
46	4.4	3.6	4.9	3.8	5.2	4.0	5.4	4.0	5.5	4.0	5.9	4.0	6.1	3.9	



4-way Air Discharge Cassette Type (MMU-AP ___ 4HP-E)

TC : Total capacity [kW] SHC : Sensible capacity [kW]

unit size	outdoor air temp. °CDB	indoor air temp.													
		14°CWB		16°CWB		18°CWB		19°CWB		20°CWB		22°CWB		24°CWB	
		20°CDB	23°CDB	26°CDB	27°CDB	28°CDB	30°CDB	32°CDB	TC	SHC	TC	SHC	TC	SHC	
030	10	7.4	5.9	8.2	6.2	8.7	6.6	9.0	6.6	9.3	6.6	9.8	6.5	10.3	6.4
	12	7.4	5.9	8.2	6.2	8.7	6.6	9.0	6.6	9.3	6.6	9.8	6.5	10.3	6.4
	14	7.4	5.9	8.2	6.2	8.7	6.6	9.0	6.6	9.3	6.6	9.8	6.5	10.3	6.4
	16	7.4	5.9	8.2	6.2	8.7	6.6	9.0	6.6	9.3	6.6	9.8	6.5	10.3	6.4
	18	7.4	5.9	8.2	6.2	8.7	6.6	9.0	6.6	9.3	6.6	9.8	6.5	10.3	6.4
	20	7.4	5.9	8.2	6.2	8.7	6.6	9.0	6.6	9.3	6.6	9.8	6.5	10.3	6.4
	21	7.4	5.9	8.2	6.2	8.7	6.6	9.0	6.6	9.3	6.6	9.8	6.5	10.3	6.4
	23	7.4	5.9	8.2	6.2	8.7	6.6	9.0	6.6	9.3	6.6	9.8	6.5	10.3	6.4
	25	7.4	5.9	8.2	6.2	8.7	6.6	9.0	6.6	9.3	6.6	9.8	6.5	10.3	6.4
	27	7.4	5.9	8.2	6.2	8.7	6.6	9.0	6.6	9.3	6.6	9.8	6.5	10.3	6.4
	29	7.4	5.9	8.2	6.2	8.7	6.6	9.0	6.6	9.3	6.6	9.8	6.5	10.3	6.4
	31	7.4	5.9	8.2	6.2	8.7	6.6	9.0	6.6	9.3	6.6	9.8	6.5	10.3	6.4
	33	7.4	5.9	8.2	6.2	8.7	6.6	9.0	6.6	9.3	6.6	9.8	6.5	10.3	6.4
	35	7.4	5.9	8.2	6.2	8.7	6.6	9.0	6.6	9.3	6.6	9.8	6.5	10.3	6.4
	37	7.2	5.7	7.9	6.0	8.5	6.4	8.7	6.4	9.0	6.4	9.5	6.3	10.0	6.2
	39	6.8	5.4	7.6	5.8	8.1	6.1	8.3	6.1	8.6	6.1	9.1	6.1	9.5	5.9
	40	6.7	5.3	7.4	5.6	7.9	6.0	8.1	5.9	8.3	5.9	8.8	5.9	9.2	5.7
42	6.2	4.9	6.8	5.2	7.3	5.5	7.5	5.5	7.8	5.5	8.2	5.5	8.6	5.3	
44	5.6	4.5	6.2	4.7	6.6	5.0	6.9	5.0	7.1	5.0	7.5	5.0	7.8	4.9	
46	5.0	3.9	5.5	4.2	5.9	4.5	6.1	4.4	6.2	4.4	6.6	4.4	6.9	4.3	
036	10	9.2	7.6	10.2	8.1	10.9	8.6	11.2	8.6	11.5	8.6	12.2	8.5	12.8	8.3
	12	9.2	7.6	10.2	8.1	10.9	8.6	11.2	8.6	11.5	8.6	12.2	8.5	12.8	8.3
	14	9.2	7.6	10.2	8.1	10.9	8.6	11.2	8.6	11.5	8.6	12.2	8.5	12.8	8.3
	16	9.2	7.6	10.2	8.1	10.9	8.6	11.2	8.6	11.5	8.6	12.2	8.5	12.8	8.3
	18	9.2	7.6	10.2	8.1	10.9	8.6	11.2	8.6	11.5	8.6	12.2	8.5	12.8	8.3
	20	9.2	7.6	10.2	8.1	10.9	8.6	11.2	8.6	11.5	8.6	12.2	8.5	12.8	8.3
	21	9.2	7.6	10.2	8.1	10.9	8.6	11.2	8.6	11.5	8.6	12.2	8.5	12.8	8.3
	23	9.2	7.6	10.2	8.1	10.9	8.6	11.2	8.6	11.5	8.6	12.2	8.5	12.8	8.3
	25	9.2	7.6	10.2	8.1	10.9	8.6	11.2	8.6	11.5	8.6	12.2	8.5	12.8	8.3
	27	9.2	7.6	10.2	8.1	10.9	8.6	11.2	8.6	11.5	8.6	12.2	8.5	12.8	8.3
	29	9.2	7.6	10.2	8.1	10.9	8.6	11.2	8.6	11.5	8.6	12.2	8.5	12.8	8.3
	31	9.2	7.6	10.2	8.1	10.9	8.6	11.2	8.6	11.5	8.6	12.2	8.5	12.8	8.3
	33	9.2	7.6	10.2	8.1	10.9	8.6	11.2	8.6	11.5	8.6	12.2	8.5	12.8	8.3
	35	9.2	7.6	10.2	8.1	10.9	8.6	11.2	8.6	11.5	8.6	12.2	8.5	12.8	8.3
	37	9.0	7.4	9.9	7.9	10.6	8.4	10.9	8.4	11.3	8.4	11.9	8.3	12.5	8.1
	39	8.6	7.1	9.5	7.6	10.2	8.1	10.5	8.1	10.8	8.1	11.4	8.0	12.0	7.8
	40	8.4	7.0	9.3	7.4	9.9	7.9	10.2	7.8	10.5	7.8	11.1	7.8	11.6	7.6
42	7.8	6.5	8.7	6.9	9.3	7.4	9.5	7.3	9.8	7.3	10.4	7.3	10.9	7.1	
44	7.2	5.9	7.9	6.3	8.5	6.7	8.7	6.7	9.0	6.7	9.5	6.6	9.9	6.5	
46	6.4	5.3	7.0	5.6	7.5	6.0	7.7	5.9	8.0	5.9	8.4	5.9	8.8	5.8	
048	10	11.5	9.5	12.7	10.1	13.6	10.7	14.0	10.7	14.4	10.7	15.3	10.6	16.0	10.4
	12	11.5	9.5	12.7	10.1	13.6	10.7	14.0	10.7	14.4	10.7	15.3	10.6	16.0	10.4
	14	11.5	9.5	12.7	10.1	13.6	10.7	14.0	10.7	14.4	10.7	15.3	10.6	16.0	10.4
	16	11.5	9.5	12.7	10.1	13.6	10.7	14.0	10.7	14.4	10.7	15.3	10.6	16.0	10.4
	18	11.5	9.5	12.7	10.1	13.6	10.7	14.0	10.7	14.4	10.7	15.3	10.6	16.0	10.4
	20	11.5	9.5	12.7	10.1	13.6	10.7	14.0	10.7	14.4	10.7	15.3	10.6	16.0	10.4
	21	11.5	9.5	12.7	10.1	13.6	10.7	14.0	10.7	14.4	10.7	15.3	10.6	16.0	10.4
	23	11.5	9.5	12.7	10.1	13.6	10.7	14.0	10.7	14.4	10.7	15.3	10.6	16.0	10.4
	25	11.5	9.5	12.7	10.1	13.6	10.7	14.0	10.7	14.4	10.7	15.3	10.6	16.0	10.4
	27	11.5	9.5	12.7	10.1	13.6	10.7	14.0	10.7	14.4	10.7	15.3	10.6	16.0	10.4
	29	11.5	9.5	12.7	10.1	13.6	10.7	14.0	10.7	14.4	10.7	15.3	10.6	16.0	10.4
	31	11.5	9.5	12.7	10.1	13.6	10.7	14.0	10.7	14.4	10.7	15.3	10.6	16.0	10.4
	33	11.5	9.5	12.7	10.1	13.6	10.7	14.0	10.7	14.4	10.7	15.3	10.6	16.0	10.4
	35	11.5	9.5	12.7	10.1	13.6	10.7	14.0	10.7	14.4	10.7	15.3	10.6	16.0	10.4
	37	11.1	9.2	12.3	9.8	13.2	10.4	13.6	10.4	14.0	10.4	14.8	10.3	15.5	10.0
	39	10.7	8.8	11.8	9.4	12.6	9.9	13.0	9.9	13.4	9.9	14.1	9.8	14.8	9.6
	40	10.3	8.5	11.4	9.1	12.2	9.7	12.6	9.6	13.0	9.6	13.7	9.5	14.4	9.3
42	9.6	7.9	10.6	8.5	11.4	9.0	11.7	9.0	12.1	9.0	12.8	8.9	13.4	8.7	
44	8.8	7.2	9.7	7.7	10.3	8.2	10.7	8.1	11.0	8.1	11.6	8.1	12.2	7.9	
46	7.7	6.4	8.5	6.8	9.1	7.2	9.4	7.2	9.7	7.2	10.3	7.1	10.7	7.0	



4-way Air Discharge Cassette Type (MMU-AP____4HP-E)

TC : Total capacity [kW] SHC : Sensible capacity [kW]

unit size	outdoor air temp. °CDB	indoor air temp.													
		14°CWB		16°CWB		18°CWB		19°CWB		20°CWB		22°CWB		24°CWB	
		20°CDB		23°CDB		26°CDB		27°CDB		28°CDB		30°CDB		32°CDB	
		TC	SHC	TC	SHC	TC	SHC	TC	SHC	TC	SHC	TC	SHC	TC	SHC
056	10	13.1	10.6	14.5	11.3	15.5	12.0	16.0	12.0	16.5	12.0	17.4	11.9	18.2	11.6
	12	13.1	10.6	14.5	11.3	15.5	12.0	16.0	12.0	16.5	12.0	17.4	11.9	18.2	11.6
	14	13.1	10.6	14.5	11.3	15.5	12.0	16.0	12.0	16.5	12.0	17.4	11.9	18.2	11.6
	16	13.1	10.6	14.5	11.3	15.5	12.0	16.0	12.0	16.5	12.0	17.4	11.9	18.2	11.6
	18	13.1	10.6	14.5	11.3	15.5	12.0	16.0	12.0	16.5	12.0	17.4	11.9	18.2	11.6
	20	13.1	10.6	14.5	11.3	15.5	12.0	16.0	12.0	16.5	12.0	17.4	11.9	18.2	11.6
	21	13.1	10.6	14.5	11.3	15.5	12.0	16.0	12.0	16.5	12.0	17.4	11.9	18.2	11.6
	23	13.1	10.6	14.5	11.3	15.5	12.0	16.0	12.0	16.5	12.0	17.4	11.9	18.2	11.6
	25	13.1	10.6	14.5	11.3	15.5	12.0	16.0	12.0	16.5	12.0	17.4	11.9	18.2	11.6
	27	13.1	10.6	14.5	11.3	15.5	12.0	16.0	12.0	16.5	12.0	17.4	11.9	18.2	11.6
	29	13.1	10.6	14.5	11.3	15.5	12.0	16.0	12.0	16.5	12.0	17.4	11.9	18.2	11.6
	31	13.1	10.6	14.5	11.3	15.5	12.0	16.0	12.0	16.5	12.0	17.4	11.9	18.2	11.6
	33	13.1	10.6	14.5	11.3	15.5	12.0	16.0	12.0	16.5	12.0	17.4	11.9	18.2	11.6
	35	13.1	10.6	14.5	11.3	15.5	12.0	16.0	12.0	16.5	12.0	17.4	11.9	18.2	11.6
	37	12.7	10.3	14.1	11.0	15.1	11.7	15.5	11.6	16.0	11.6	16.9	11.5	17.7	11.3
	39	12.2	9.9	13.5	10.5	14.4	11.2	14.8	11.1	15.3	11.1	16.2	11.0	16.9	10.8
	40	11.8	9.6	13.1	10.2	14.0	10.8	14.4	10.8	14.8	10.8	15.7	10.7	16.4	10.5
42	11.0	8.9	12.2	9.5	13.0	10.1	13.4	10.0	13.8	10.0	14.6	10.0	15.3	9.7	
44	10.0	8.1	11.1	8.6	11.8	9.2	12.2	9.1	12.5	9.1	13.3	9.1	13.9	8.8	
46	8.8	7.2	9.8	7.6	10.4	8.1	10.8	8.1	11.1	8.1	11.7	8.0	12.3	7.8	



Compact 4-way Cassette (600 x 600) Type (MMU-AP___4MH-E)

TC : Total capacity [kW] SHC : Sensible capacity [kW]

unit size	outdoor air temp. °CDB	indoor air temp.													
		14°CWB		16°CWB		18°CWB		19°CWB		20°CWB		22°CWB		24°CWB	
		20°CDB		23°CDB		26°CDB		27°CDB		28°CDB		30°CDB		32°CDB	
		TC	SHC	TC	SHC	TC	SHC	TC	SHC	TC	SHC	TC	SHC	TC	SHC
007	10	1.8	1.6	2.0	1.7	2.1	1.8	2.2	1.8	2.3	1.8	2.4	1.8	2.5	1.7
	12	1.8	1.6	2.0	1.7	2.1	1.8	2.2	1.8	2.3	1.8	2.4	1.8	2.5	1.7
	14	1.8	1.6	2.0	1.7	2.1	1.8	2.2	1.8	2.3	1.8	2.4	1.8	2.5	1.7
	16	1.8	1.6	2.0	1.7	2.1	1.8	2.2	1.8	2.3	1.8	2.4	1.8	2.5	1.7
	18	1.8	1.6	2.0	1.7	2.1	1.8	2.2	1.8	2.3	1.8	2.4	1.8	2.5	1.7
	20	1.8	1.6	2.0	1.7	2.1	1.8	2.2	1.8	2.3	1.8	2.4	1.8	2.5	1.7
	21	1.8	1.6	2.0	1.7	2.1	1.8	2.2	1.8	2.3	1.8	2.4	1.8	2.5	1.7
	23	1.8	1.6	2.0	1.7	2.1	1.8	2.2	1.8	2.3	1.8	2.4	1.8	2.5	1.7
	25	1.8	1.6	2.0	1.7	2.1	1.8	2.2	1.8	2.3	1.8	2.4	1.8	2.5	1.7
	27	1.8	1.6	2.0	1.7	2.1	1.8	2.2	1.8	2.3	1.8	2.4	1.8	2.5	1.7
	29	1.8	1.6	2.0	1.7	2.1	1.8	2.2	1.8	2.3	1.8	2.4	1.8	2.5	1.7
	31	1.8	1.6	2.0	1.7	2.1	1.8	2.2	1.8	2.3	1.8	2.4	1.8	2.5	1.7
	33	1.8	1.6	2.0	1.7	2.1	1.8	2.2	1.8	2.3	1.8	2.4	1.8	2.5	1.7
	35	1.8	1.6	2.0	1.7	2.1	1.8	2.2	1.8	2.3	1.8	2.4	1.8	2.5	1.7
	37	1.8	1.5	1.9	1.6	2.1	1.8	2.1	1.7	2.2	1.7	2.3	1.7	2.4	1.7
39	1.7	1.5	1.9	1.6	2.0	1.7	2.0	1.7	2.1	1.7	2.2	1.7	2.3	1.6	
40	1.6	1.4	1.8	1.5	1.9	1.6	2.0	1.6	2.0	1.6	2.2	1.6	2.3	1.6	
42	1.5	1.3	1.7	1.4	1.8	1.5	1.8	1.5	1.9	1.5	2.0	1.5	2.1	1.5	
44	1.4	1.2	1.5	1.3	1.6	1.4	1.7	1.4	1.7	1.4	1.8	1.4	1.9	1.3	
46	1.2	1.1	1.3	1.1	1.4	1.2	1.5	1.2	1.5	1.2	1.6	1.2	1.7	1.2	
009	10	2.3	2.0	2.5	2.1	2.7	2.2	2.8	2.2	2.9	2.2	3.1	2.2	3.2	2.1
	12	2.3	2.0	2.5	2.1	2.7	2.2	2.8	2.2	2.9	2.2	3.1	2.2	3.2	2.1
	14	2.3	2.0	2.5	2.1	2.7	2.2	2.8	2.2	2.9	2.2	3.1	2.2	3.2	2.1
	16	2.3	2.0	2.5	2.1	2.7	2.2	2.8	2.2	2.9	2.2	3.1	2.2	3.2	2.1
	18	2.3	2.0	2.5	2.1	2.7	2.2	2.8	2.2	2.9	2.2	3.1	2.2	3.2	2.1
	20	2.3	2.0	2.5	2.1	2.7	2.2	2.8	2.2	2.9	2.2	3.1	2.2	3.2	2.1
	21	2.3	2.0	2.5	2.1	2.7	2.2	2.8	2.2	2.9	2.2	3.1	2.2	3.2	2.1
	23	2.3	2.0	2.5	2.1	2.7	2.2	2.8	2.2	2.9	2.2	3.1	2.2	3.2	2.1
	25	2.3	2.0	2.5	2.1	2.7	2.2	2.8	2.2	2.9	2.2	3.1	2.2	3.2	2.1
	27	2.3	2.0	2.5	2.1	2.7	2.2	2.8	2.2	2.9	2.2	3.1	2.2	3.2	2.1
	29	2.3	2.0	2.5	2.1	2.7	2.2	2.8	2.2	2.9	2.2	3.1	2.2	3.2	2.1
	31	2.3	2.0	2.5	2.1	2.7	2.2	2.8	2.2	2.9	2.2	3.1	2.2	3.2	2.1
	33	2.3	2.0	2.5	2.1	2.7	2.2	2.8	2.2	2.9	2.2	3.1	2.2	3.2	2.1
	35	2.3	2.0	2.5	2.1	2.7	2.2	2.8	2.2	2.9	2.2	3.1	2.2	3.2	2.1
	37	2.2	1.9	2.5	2.0	2.6	2.1	2.7	2.1	2.8	2.1	3.0	2.1	3.1	2.1
39	2.1	1.8	2.4	1.9	2.5	2.0	2.6	2.0	2.7	2.0	2.8	2.0	3.0	2.0	
40	2.1	1.8	2.3	1.9	2.4	2.0	2.5	2.0	2.6	2.0	2.7	2.0	2.9	1.9	
42	1.9	1.6	2.1	1.7	2.3	1.8	2.3	1.8	2.4	1.8	2.6	1.8	2.7	1.8	
44	1.8	1.5	1.9	1.6	2.1	1.7	2.1	1.7	2.2	1.7	2.3	1.7	2.4	1.6	
46	1.5	1.3	1.7	1.4	1.8	1.5	1.9	1.5	1.9	1.5	2.1	1.5	2.1	1.4	



Compact 4-way Cassette (600 x 600) Type (MMU-AP ___4MH-E)

TC : Total capacity [kW] SHC : Sensible capacity [kW]

unit size	outdoor air temp. °CDB	indoor air temp.													
		14°CWB		16°CWB		18°CWB		19°CWB		20°CWB		22°CWB		24°CWB	
		20°CDB		23°CDB		26°CDB		27°CDB		28°CDB		30°CDB		32°CDB	
		TC	SHC	TC	SHC	TC	SHC	TC	SHC	TC	SHC	TC	SHC	TC	SHC
012	10	3.0	2.4	3.3	2.5	3.5	2.7	3.6	2.7	3.7	2.7	3.9	2.7	4.1	2.6
	12	3.0	2.4	3.3	2.5	3.5	2.7	3.6	2.7	3.7	2.7	3.9	2.7	4.1	2.6
	14	3.0	2.4	3.3	2.5	3.5	2.7	3.6	2.7	3.7	2.7	3.9	2.7	4.1	2.6
	16	3.0	2.4	3.3	2.5	3.5	2.7	3.6	2.7	3.7	2.7	3.9	2.7	4.1	2.6
	18	3.0	2.4	3.3	2.5	3.5	2.7	3.6	2.7	3.7	2.7	3.9	2.7	4.1	2.6
	20	3.0	2.4	3.3	2.5	3.5	2.7	3.6	2.7	3.7	2.7	3.9	2.7	4.1	2.6
	21	3.0	2.4	3.3	2.5	3.5	2.7	3.6	2.7	3.7	2.7	3.9	2.7	4.1	2.6
	23	3.0	2.4	3.3	2.5	3.5	2.7	3.6	2.7	3.7	2.7	3.9	2.7	4.1	2.6
	25	3.0	2.4	3.3	2.5	3.5	2.7	3.6	2.7	3.7	2.7	3.9	2.7	4.1	2.6
	27	3.0	2.4	3.3	2.5	3.5	2.7	3.6	2.7	3.7	2.7	3.9	2.7	4.1	2.6
	29	3.0	2.4	3.3	2.5	3.5	2.7	3.6	2.7	3.7	2.7	3.9	2.7	4.1	2.6
	31	3.0	2.4	3.3	2.5	3.5	2.7	3.6	2.7	3.7	2.7	3.9	2.7	4.1	2.6
	33	3.0	2.4	3.3	2.5	3.5	2.7	3.6	2.7	3.7	2.7	3.9	2.7	4.1	2.6
	35	3.0	2.4	3.3	2.5	3.5	2.7	3.6	2.7	3.7	2.7	3.9	2.7	4.1	2.6
	37	2.9	2.3	3.2	2.5	3.4	2.6	3.5	2.6	3.6	2.6	3.8	2.6	4.0	2.5
	39	2.7	2.2	3.0	2.4	3.2	2.5	3.3	2.5	3.4	2.5	3.6	2.5	3.8	2.4
40	2.7	2.2	2.9	2.3	3.1	2.4	3.2	2.4	3.3	2.4	3.5	2.4	3.7	2.4	
42	2.5	2.0	2.7	2.1	2.9	2.3	3.0	2.3	3.1	2.3	3.3	2.2	3.4	2.2	
44	2.3	1.8	2.5	1.9	2.7	2.1	2.7	2.1	2.8	2.1	3.0	2.0	3.1	2.0	
46	2.0	1.6	2.2	1.7	2.3	1.8	2.4	1.8	2.5	1.8	2.6	1.8	2.8	1.8	
015	10	3.7	2.9	4.1	3.1	4.4	3.3	4.5	3.3	4.6	3.3	4.9	3.3	5.1	3.2
	12	3.7	2.9	4.1	3.1	4.4	3.3	4.5	3.3	4.6	3.3	4.9	3.3	5.1	3.2
	14	3.7	2.9	4.1	3.1	4.4	3.3	4.5	3.3	4.6	3.3	4.9	3.3	5.1	3.2
	16	3.7	2.9	4.1	3.1	4.4	3.3	4.5	3.3	4.6	3.3	4.9	3.3	5.1	3.2
	18	3.7	2.9	4.1	3.1	4.4	3.3	4.5	3.3	4.6	3.3	4.9	3.3	5.1	3.2
	20	3.7	2.9	4.1	3.1	4.4	3.3	4.5	3.3	4.6	3.3	4.9	3.3	5.1	3.2
	21	3.7	2.9	4.1	3.1	4.4	3.3	4.5	3.3	4.6	3.3	4.9	3.3	5.1	3.2
	23	3.7	2.9	4.1	3.1	4.4	3.3	4.5	3.3	4.6	3.3	4.9	3.3	5.1	3.2
	25	3.7	2.9	4.1	3.1	4.4	3.3	4.5	3.3	4.6	3.3	4.9	3.3	5.1	3.2
	27	3.7	2.9	4.1	3.1	4.4	3.3	4.5	3.3	4.6	3.3	4.9	3.3	5.1	3.2
	29	3.7	2.9	4.1	3.1	4.4	3.3	4.5	3.3	4.6	3.3	4.9	3.3	5.1	3.2
	31	3.7	2.9	4.1	3.1	4.4	3.3	4.5	3.3	4.6	3.3	4.9	3.3	5.1	3.2
	33	3.7	2.9	4.1	3.1	4.4	3.3	4.5	3.3	4.6	3.3	4.9	3.3	5.1	3.2
	35	3.7	2.9	4.1	3.1	4.4	3.3	4.5	3.3	4.6	3.3	4.9	3.3	5.1	3.2
	37	3.6	2.8	4.0	3.0	4.2	3.2	4.4	3.2	4.5	3.2	4.8	3.2	5.0	3.1
	39	3.4	2.7	3.8	2.9	4.0	3.1	4.2	3.1	4.3	3.1	4.5	3.0	4.8	3.0
40	3.3	2.6	3.7	2.8	3.9	3.0	4.1	3.0	4.2	3.0	4.4	2.9	4.6	2.9	
42	3.1	2.4	3.4	2.6	3.7	2.8	3.8	2.8	3.9	2.8	4.1	2.7	4.3	2.7	
44	2.8	2.2	3.1	2.4	3.3	2.5	3.4	2.5	3.5	2.5	3.7	2.5	3.9	2.4	
46	2.5	2.0	2.7	2.1	2.9	2.2	3.0	2.2	3.1	2.2	3.3	2.2	3.4	2.1	
018	10	4.6	3.5	5.1	3.8	5.4	4.0	5.6	4.0	5.8	4.0	6.1	4.0	6.4	3.9
	12	4.6	3.5	5.1	3.8	5.4	4.0	5.6	4.0	5.8	4.0	6.1	4.0	6.4	3.9
	14	4.6	3.5	5.1	3.8	5.4	4.0	5.6	4.0	5.8	4.0	6.1	4.0	6.4	3.9
	16	4.6	3.5	5.1	3.8	5.4	4.0	5.6	4.0	5.8	4.0	6.1	4.0	6.4	3.9
	18	4.6	3.5	5.1	3.8	5.4	4.0	5.6	4.0	5.8	4.0	6.1	4.0	6.4	3.9
	20	4.6	3.5	5.1	3.8	5.4	4.0	5.6	4.0	5.8	4.0	6.1	4.0	6.4	3.9
	21	4.6	3.5	5.1	3.8	5.4	4.0	5.6	4.0	5.8	4.0	6.1	4.0	6.4	3.9
	23	4.6	3.5	5.1	3.8	5.4	4.0	5.6	4.0	5.8	4.0	6.1	4.0	6.4	3.9
	25	4.6	3.5	5.1	3.8	5.4	4.0	5.6	4.0	5.8	4.0	6.1	4.0	6.4	3.9
	27	4.6	3.5	5.1	3.8	5.4	4.0	5.6	4.0	5.8	4.0	6.1	4.0	6.4	3.9
	29	4.6	3.5	5.1	3.8	5.4	4.0	5.6	4.0	5.8	4.0	6.1	4.0	6.4	3.9
	31	4.6	3.5	5.1	3.8	5.4	4.0	5.6	4.0	5.8	4.0	6.1	4.0	6.4	3.9
	33	4.6	3.5	5.1	3.8	5.4	4.0	5.6	4.0	5.8	4.0	6.1	4.0	6.4	3.9
	35	4.6	3.5	5.1	3.8	5.4	4.0	5.6	4.0	5.8	4.0	6.1	4.0	6.4	3.9
	37	4.5	3.4	4.9	3.7	5.3	3.9	5.4	3.9	5.6	3.9	5.9	3.8	6.2	3.8
	39	4.3	3.3	4.7	3.5	5.0	3.7	5.2	3.7	5.3	3.7	5.7	3.7	5.9	3.6
40	4.1	3.2	4.6	3.4	4.9	3.6	5.0	3.6	5.2	3.6	5.5	3.6	5.7	3.5	
42	3.8	3.0	4.3	3.2	4.5	3.4	4.7	3.3	4.8	3.3	5.1	3.3	5.3	3.2	
44	3.5	2.7	3.9	2.9	4.1	3.1	4.3	3.0	4.4	3.0	4.6	3.0	4.9	2.9	
46	3.1	2.4	3.4	2.5	3.7	2.7	3.8	2.7	3.9	2.7	4.1	2.7	4.3	2.6	



2-way Air Discharge Cassette Type (MMU-AP___2WH)

TC : Total capacity [kW] SHC : Sensible capacity [kW]

unit size	outdoor air temp. °CDB	indoor air temp.													
		14°CWB		16°CWB		18°CWB		19°CWB		20°CWB		22°CWB		24°CWB	
		20°CDB	23°CDB	26°CDB	27°CDB	28°CDB	30°CDB	32°CDB	TC	SHC	TC	SHC	TC	SHC	TC
007	10	1.8	1.6	2.0	1.7	2.1	1.8	2.2	1.8	2.3	1.8	2.4	1.8	2.5	1.7
	12	1.8	1.6	2.0	1.7	2.1	1.8	2.2	1.8	2.3	1.8	2.4	1.8	2.5	1.7
	14	1.8	1.6	2.0	1.7	2.1	1.8	2.2	1.8	2.3	1.8	2.4	1.8	2.5	1.7
	16	1.8	1.6	2.0	1.7	2.1	1.8	2.2	1.8	2.3	1.8	2.4	1.8	2.5	1.7
	18	1.8	1.6	2.0	1.7	2.1	1.8	2.2	1.8	2.3	1.8	2.4	1.8	2.5	1.7
	20	1.8	1.6	2.0	1.7	2.1	1.8	2.2	1.8	2.3	1.8	2.4	1.8	2.5	1.7
	21	1.8	1.6	2.0	1.7	2.1	1.8	2.2	1.8	2.3	1.8	2.4	1.8	2.5	1.7
	23	1.8	1.6	2.0	1.7	2.1	1.8	2.2	1.8	2.3	1.8	2.4	1.8	2.5	1.7
	25	1.8	1.6	2.0	1.7	2.1	1.8	2.2	1.8	2.3	1.8	2.4	1.8	2.5	1.7
	27	1.8	1.6	2.0	1.7	2.1	1.8	2.2	1.8	2.3	1.8	2.4	1.8	2.5	1.7
	29	1.8	1.6	2.0	1.7	2.1	1.8	2.2	1.8	2.3	1.8	2.4	1.8	2.5	1.7
	31	1.8	1.6	2.0	1.7	2.1	1.8	2.2	1.8	2.3	1.8	2.4	1.8	2.5	1.7
	33	1.8	1.6	2.0	1.7	2.1	1.8	2.2	1.8	2.3	1.8	2.4	1.8	2.5	1.7
	35	1.8	1.6	2.0	1.7	2.1	1.8	2.2	1.8	2.3	1.8	2.4	1.8	2.5	1.7
	37	1.8	1.5	1.9	1.6	2.1	1.8	2.1	1.7	2.2	1.7	2.3	1.7	2.4	1.7
	39	1.7	1.5	1.9	1.6	2.0	1.7	2.0	1.7	2.1	1.7	2.2	1.7	2.3	1.6
	40	1.6	1.4	1.8	1.5	1.9	1.6	2.0	1.6	2.0	1.6	2.2	1.6	2.3	1.6
42	1.5	1.3	1.7	1.4	1.8	1.5	1.8	1.5	1.9	1.5	2.0	1.5	2.1	1.5	
44	1.4	1.2	1.5	1.3	1.6	1.4	1.7	1.4	1.7	1.4	1.8	1.4	1.9	1.3	
46	1.2	1.1	1.3	1.1	1.4	1.2	1.5	1.2	1.5	1.2	1.6	1.2	1.7	1.2	
009	10	2.3	2.0	2.5	2.1	2.7	2.2	2.8	2.2	2.9	2.2	3.1	2.2	3.2	2.1
	12	2.3	2.0	2.5	2.1	2.7	2.2	2.8	2.2	2.9	2.2	3.1	2.2	3.2	2.1
	14	2.3	2.0	2.5	2.1	2.7	2.2	2.8	2.2	2.9	2.2	3.1	2.2	3.2	2.1
	16	2.3	2.0	2.5	2.1	2.7	2.2	2.8	2.2	2.9	2.2	3.1	2.2	3.2	2.1
	18	2.3	2.0	2.5	2.1	2.7	2.2	2.8	2.2	2.9	2.2	3.1	2.2	3.2	2.1
	20	2.3	2.0	2.5	2.1	2.7	2.2	2.8	2.2	2.9	2.2	3.1	2.2	3.2	2.1
	21	2.3	2.0	2.5	2.1	2.7	2.2	2.8	2.2	2.9	2.2	3.1	2.2	3.2	2.1
	23	2.3	2.0	2.5	2.1	2.7	2.2	2.8	2.2	2.9	2.2	3.1	2.2	3.2	2.1
	25	2.3	2.0	2.5	2.1	2.7	2.2	2.8	2.2	2.9	2.2	3.1	2.2	3.2	2.1
	27	2.3	2.0	2.5	2.1	2.7	2.2	2.8	2.2	2.9	2.2	3.1	2.2	3.2	2.1
	29	2.3	2.0	2.5	2.1	2.7	2.2	2.8	2.2	2.9	2.2	3.1	2.2	3.2	2.1
	31	2.3	2.0	2.5	2.1	2.7	2.2	2.8	2.2	2.9	2.2	3.1	2.2	3.2	2.1
	33	2.3	2.0	2.5	2.1	2.7	2.2	2.8	2.2	2.9	2.2	3.1	2.2	3.2	2.1
	35	2.3	2.0	2.5	2.1	2.7	2.2	2.8	2.2	2.9	2.2	3.1	2.2	3.2	2.1
	37	2.2	1.9	2.5	2.0	2.6	2.1	2.7	2.1	2.8	2.1	3.0	2.1	3.1	2.1
	39	2.1	1.8	2.4	1.9	2.5	2.0	2.6	2.0	2.7	2.0	2.8	2.0	3.0	2.0
	40	2.1	1.8	2.3	1.9	2.4	2.0	2.5	2.0	2.6	2.0	2.7	2.0	2.9	1.9
42	1.9	1.6	2.1	1.7	2.3	1.8	2.3	1.8	2.4	1.8	2.6	1.8	2.7	1.8	
44	1.8	1.5	1.9	1.6	2.1	1.7	2.1	1.7	2.2	1.7	2.3	1.7	2.4	1.6	
46	1.5	1.3	1.7	1.4	1.8	1.5	1.9	1.5	1.9	1.5	2.1	1.5	2.1	1.4	
012	10	3.0	2.4	3.3	2.5	3.5	2.7	3.6	2.7	3.7	2.7	3.9	2.7	4.1	2.6
	12	3.0	2.4	3.3	2.5	3.5	2.7	3.6	2.7	3.7	2.7	3.9	2.7	4.1	2.6
	14	3.0	2.4	3.3	2.5	3.5	2.7	3.6	2.7	3.7	2.7	3.9	2.7	4.1	2.6
	16	3.0	2.4	3.3	2.5	3.5	2.7	3.6	2.7	3.7	2.7	3.9	2.7	4.1	2.6
	18	3.0	2.4	3.3	2.5	3.5	2.7	3.6	2.7	3.7	2.7	3.9	2.7	4.1	2.6
	20	3.0	2.4	3.3	2.5	3.5	2.7	3.6	2.7	3.7	2.7	3.9	2.7	4.1	2.6
	21	3.0	2.4	3.3	2.5	3.5	2.7	3.6	2.7	3.7	2.7	3.9	2.7	4.1	2.6
	23	3.0	2.4	3.3	2.5	3.5	2.7	3.6	2.7	3.7	2.7	3.9	2.7	4.1	2.6
	25	3.0	2.4	3.3	2.5	3.5	2.7	3.6	2.7	3.7	2.7	3.9	2.7	4.1	2.6
	27	3.0	2.4	3.3	2.5	3.5	2.7	3.6	2.7	3.7	2.7	3.9	2.7	4.1	2.6
	29	3.0	2.4	3.3	2.5	3.5	2.7	3.6	2.7	3.7	2.7	3.9	2.7	4.1	2.6
	31	3.0	2.4	3.3	2.5	3.5	2.7	3.6	2.7	3.7	2.7	3.9	2.7	4.1	2.6
	33	3.0	2.4	3.3	2.5	3.5	2.7	3.6	2.7	3.7	2.7	3.9	2.7	4.1	2.6
	35	3.0	2.4	3.3	2.5	3.5	2.7	3.6	2.7	3.7	2.7	3.9	2.7	4.1	2.6
	37	2.9	2.3	3.2	2.5	3.4	2.6	3.5	2.6	3.6	2.6	3.8	2.6	4.0	2.5
	39	2.7	2.2	3.0	2.4	3.2	2.5	3.3	2.5	3.4	2.5	3.6	2.5	3.8	2.4
	40	2.7	2.2	2.9	2.3	3.1	2.4	3.2	2.4	3.3	2.4	3.5	2.4	3.7	2.4
42	2.5	2.0	2.7	2.1	2.9	2.3	3.0	2.3	3.1	2.3	3.3	2.2	3.4	2.2	
44	2.3	1.8	2.5	1.9	2.7	2.1	2.7	2.1	2.8	2.1	3.0	2.0	3.1	2.0	
46	2.0	1.6	2.2	1.7	2.3	1.8	2.4	1.8	2.5	1.8	2.6	1.8	2.8	1.8	



2-way Air Discharge Cassette Type (MMU-AP___2WH)

TC : Total capacity [kW] SHC : Sensible capacity [kW]

unit size	outdoor air temp. °CDB	indoor air temp.													
		14°CWB		16°CWB		18°CWB		19°CWB		20°CWB		22°CWB		24°CWB	
		20°CDB	23°CDB	26°CDB	27°CDB	28°CDB	30°CDB	32°CDB	TC	SHC	TC	SHC	TC	SHC	TC
015	10	3.7	2.8	4.1	3.0	4.4	3.2	4.5	3.2	4.6	3.2	4.9	3.2	5.1	3.1
	12	3.7	2.8	4.1	3.0	4.4	3.2	4.5	3.2	4.6	3.2	4.9	3.2	5.1	3.1
	14	3.7	2.8	4.1	3.0	4.4	3.2	4.5	3.2	4.6	3.2	4.9	3.2	5.1	3.1
	16	3.7	2.8	4.1	3.0	4.4	3.2	4.5	3.2	4.6	3.2	4.9	3.2	5.1	3.1
	18	3.7	2.8	4.1	3.0	4.4	3.2	4.5	3.2	4.6	3.2	4.9	3.2	5.1	3.1
	20	3.7	2.8	4.1	3.0	4.4	3.2	4.5	3.2	4.6	3.2	4.9	3.2	5.1	3.1
	21	3.7	2.8	4.1	3.0	4.4	3.2	4.5	3.2	4.6	3.2	4.9	3.2	5.1	3.1
	23	3.7	2.8	4.1	3.0	4.4	3.2	4.5	3.2	4.6	3.2	4.9	3.2	5.1	3.1
	25	3.7	2.8	4.1	3.0	4.4	3.2	4.5	3.2	4.6	3.2	4.9	3.2	5.1	3.1
	27	3.7	2.8	4.1	3.0	4.4	3.2	4.5	3.2	4.6	3.2	4.9	3.2	5.1	3.1
	29	3.7	2.8	4.1	3.0	4.4	3.2	4.5	3.2	4.6	3.2	4.9	3.2	5.1	3.1
	31	3.7	2.8	4.1	3.0	4.4	3.2	4.5	3.2	4.6	3.2	4.9	3.2	5.1	3.1
	33	3.7	2.8	4.1	3.0	4.4	3.2	4.5	3.2	4.6	3.2	4.9	3.2	5.1	3.1
	35	3.7	2.8	4.1	3.0	4.4	3.2	4.5	3.2	4.6	3.2	4.9	3.2	5.1	3.1
	37	3.6	2.8	4.0	2.9	4.2	3.1	4.4	3.1	4.5	3.1	4.8	3.1	5.0	3.0
	39	3.4	2.6	3.8	2.8	4.0	3.0	4.2	3.0	4.3	3.0	4.5	2.9	4.8	2.9
40	3.3	2.6	3.7	2.7	3.9	2.9	4.1	2.9	4.2	2.9	4.4	2.9	4.6	2.8	
42	3.1	2.4	3.4	2.5	3.7	2.7	3.8	2.7	3.9	2.7	4.1	2.7	4.3	2.6	
44	2.8	2.2	3.1	2.3	3.3	2.4	3.4	2.4	3.5	2.4	3.7	2.4	3.9	2.4	
46	2.5	1.9	2.7	2.0	2.9	2.2	3.0	2.2	3.1	2.2	3.3	2.1	3.4	2.1	
018	10	4.6	3.6	5.1	3.9	5.4	4.1	5.6	4.1	5.8	4.1	6.1	4.1	6.4	4.0
	12	4.6	3.6	5.1	3.9	5.4	4.1	5.6	4.1	5.8	4.1	6.1	4.1	6.4	4.0
	14	4.6	3.6	5.1	3.9	5.4	4.1	5.6	4.1	5.8	4.1	6.1	4.1	6.4	4.0
	16	4.6	3.6	5.1	3.9	5.4	4.1	5.6	4.1	5.8	4.1	6.1	4.1	6.4	4.0
	18	4.6	3.6	5.1	3.9	5.4	4.1	5.6	4.1	5.8	4.1	6.1	4.1	6.4	4.0
	20	4.6	3.6	5.1	3.9	5.4	4.1	5.6	4.1	5.8	4.1	6.1	4.1	6.4	4.0
	21	4.6	3.6	5.1	3.9	5.4	4.1	5.6	4.1	5.8	4.1	6.1	4.1	6.4	4.0
	23	4.6	3.6	5.1	3.9	5.4	4.1	5.6	4.1	5.8	4.1	6.1	4.1	6.4	4.0
	25	4.6	3.6	5.1	3.9	5.4	4.1	5.6	4.1	5.8	4.1	6.1	4.1	6.4	4.0
	27	4.6	3.6	5.1	3.9	5.4	4.1	5.6	4.1	5.8	4.1	6.1	4.1	6.4	4.0
	29	4.6	3.6	5.1	3.9	5.4	4.1	5.6	4.1	5.8	4.1	6.1	4.1	6.4	4.0
	31	4.6	3.6	5.1	3.9	5.4	4.1	5.6	4.1	5.8	4.1	6.1	4.1	6.4	4.0
	33	4.6	3.6	5.1	3.9	5.4	4.1	5.6	4.1	5.8	4.1	6.1	4.1	6.4	4.0
	35	4.6	3.6	5.1	3.9	5.4	4.1	5.6	4.1	5.8	4.1	6.1	4.1	6.4	4.0
	37	4.5	3.5	4.9	3.8	5.3	4.0	5.4	4.0	5.6	4.0	5.9	3.9	6.2	3.8
	39	4.3	3.4	4.7	3.6	5.0	3.8	5.2	3.8	5.3	3.8	5.7	3.8	5.9	3.7
40	4.1	3.3	4.6	3.5	4.9	3.7	5.0	3.7	5.2	3.7	5.5	3.7	5.7	3.6	
42	3.8	3.0	4.3	3.2	4.5	3.4	4.7	3.4	4.8	3.4	5.1	3.4	5.3	3.3	
44	3.5	2.8	3.9	2.9	4.1	3.1	4.3	3.1	4.4	3.1	4.6	3.1	4.9	3.0	
46	3.1	2.4	3.4	2.6	3.7	2.8	3.8	2.8	3.9	2.8	4.1	2.7	4.3	2.7	
024	10	5.8	4.5	6.4	4.8	6.9	5.1	7.1	5.1	7.3	5.1	7.7	5.1	8.1	4.9
	12	5.8	4.5	6.4	4.8	6.9	5.1	7.1	5.1	7.3	5.1	7.7	5.1	8.1	4.9
	14	5.8	4.5	6.4	4.8	6.9	5.1	7.1	5.1	7.3	5.1	7.7	5.1	8.1	4.9
	16	5.8	4.5	6.4	4.8	6.9	5.1	7.1	5.1	7.3	5.1	7.7	5.1	8.1	4.9
	18	5.8	4.5	6.4	4.8	6.9	5.1	7.1	5.1	7.3	5.1	7.7	5.1	8.1	4.9
	20	5.8	4.5	6.4	4.8	6.9	5.1	7.1	5.1	7.3	5.1	7.7	5.1	8.1	4.9
	21	5.8	4.5	6.4	4.8	6.9	5.1	7.1	5.1	7.3	5.1	7.7	5.1	8.1	4.9
	23	5.8	4.5	6.4	4.8	6.9	5.1	7.1	5.1	7.3	5.1	7.7	5.1	8.1	4.9
	25	5.8	4.5	6.4	4.8	6.9	5.1	7.1	5.1	7.3	5.1	7.7	5.1	8.1	4.9
	27	5.8	4.5	6.4	4.8	6.9	5.1	7.1	5.1	7.3	5.1	7.7	5.1	8.1	4.9
	29	5.8	4.5	6.4	4.8	6.9	5.1	7.1	5.1	7.3	5.1	7.7	5.1	8.1	4.9
	31	5.8	4.5	6.4	4.8	6.9	5.1	7.1	5.1	7.3	5.1	7.7	5.1	8.1	4.9
	33	5.8	4.5	6.4	4.8	6.9	5.1	7.1	5.1	7.3	5.1	7.7	5.1	8.1	4.9
	35	5.8	4.5	6.4	4.8	6.9	5.1	7.1	5.1	7.3	5.1	7.7	5.1	8.1	4.9
	37	5.7	4.4	6.3	4.7	6.7	5.0	6.9	4.9	7.1	4.9	7.5	4.9	7.9	4.8
	39	5.4	4.2	6.0	4.5	6.4	4.7	6.6	4.7	6.8	4.7	7.2	4.7	7.5	4.6
40	5.2	4.1	5.8	4.3	6.2	4.6	6.4	4.6	6.6	4.6	7.0	4.5	7.3	4.4	
42	4.9	3.8	5.4	4.0	5.8	4.3	5.9	4.3	6.1	4.3	6.5	4.2	6.8	4.1	
44	4.4	3.4	4.9	3.7	5.2	3.9	5.4	3.9	5.6	3.9	5.9	3.8	6.2	3.8	
46	3.9	3.0	4.3	3.2	4.6	3.4	4.8	3.4	4.9	3.4	5.2	3.4	5.4	3.3	



2-way Air Discharge Cassette Type (MMU-AP ___2WH)

TC : Total capacity [kW] SHC : Sensible capacity [kW]

unit size	outdoor air temp. °CDB	indoor air temp.													
		14°CWB		16°CWB		18°CWB		19°CWB		20°CWB		22°CWB		24°CWB	
		20°CDB	23°CDB	26°CDB	27°CDB	28°CDB	30°CDB	32°CDB	TC	SHC	TC	SHC	TC	SHC	TC
027	10	6.6	5.0	7.3	5.3	7.8	5.6	8.0	5.6	8.2	5.6	8.7	5.5	9.1	5.4
	12	6.6	5.0	7.3	5.3	7.8	5.6	8.0	5.6	8.2	5.6	8.7	5.5	9.1	5.4
	14	6.6	5.0	7.3	5.3	7.8	5.6	8.0	5.6	8.2	5.6	8.7	5.5	9.1	5.4
	16	6.6	5.0	7.3	5.3	7.8	5.6	8.0	5.6	8.2	5.6	8.7	5.5	9.1	5.4
	18	6.6	5.0	7.3	5.3	7.8	5.6	8.0	5.6	8.2	5.6	8.7	5.5	9.1	5.4
	20	6.6	5.0	7.3	5.3	7.8	5.6	8.0	5.6	8.2	5.6	8.7	5.5	9.1	5.4
	21	6.6	5.0	7.3	5.3	7.8	5.6	8.0	5.6	8.2	5.6	8.7	5.5	9.1	5.4
	23	6.6	5.0	7.3	5.3	7.8	5.6	8.0	5.6	8.2	5.6	8.7	5.5	9.1	5.4
	25	6.6	5.0	7.3	5.3	7.8	5.6	8.0	5.6	8.2	5.6	8.7	5.5	9.1	5.4
	27	6.6	5.0	7.3	5.3	7.8	5.6	8.0	5.6	8.2	5.6	8.7	5.5	9.1	5.4
	29	6.6	5.0	7.3	5.3	7.8	5.6	8.0	5.6	8.2	5.6	8.7	5.5	9.1	5.4
	31	6.6	5.0	7.3	5.3	7.8	5.6	8.0	5.6	8.2	5.6	8.7	5.5	9.1	5.4
	33	6.6	5.0	7.3	5.3	7.8	5.6	8.0	5.6	8.2	5.6	8.7	5.5	9.1	5.4
	35	6.6	5.0	7.3	5.3	7.8	5.6	8.0	5.6	8.2	5.6	8.7	5.5	9.1	5.4
	37	6.4	4.8	7.0	5.1	7.5	5.4	7.8	5.4	8.0	5.4	8.5	5.4	8.8	5.3
	39	6.1	4.6	6.7	4.9	7.2	5.2	7.4	5.2	7.6	5.2	8.1	5.1	8.5	5.0
40	5.9	4.5	6.5	4.8	7.0	5.1	7.2	5.0	7.4	5.0	7.8	5.0	8.2	4.9	
42	5.5	4.2	6.1	4.4	6.5	4.7	6.7	4.7	6.9	4.7	7.3	4.6	7.6	4.5	
44	5.0	3.8	5.5	4.0	5.9	4.3	6.1	4.3	6.3	4.3	6.6	4.2	6.9	4.1	
46	4.4	3.3	4.9	3.6	5.2	3.8	5.4	3.8	5.5	3.8	5.9	3.7	6.1	3.6	
030	10	7.4	5.5	8.2	5.9	8.7	6.2	9.0	6.2	9.3	6.2	9.8	6.1	10.3	6.0
	12	7.4	5.5	8.2	5.9	8.7	6.2	9.0	6.2	9.3	6.2	9.8	6.1	10.3	6.0
	14	7.4	5.5	8.2	5.9	8.7	6.2	9.0	6.2	9.3	6.2	9.8	6.1	10.3	6.0
	16	7.4	5.5	8.2	5.9	8.7	6.2	9.0	6.2	9.3	6.2	9.8	6.1	10.3	6.0
	18	7.4	5.5	8.2	5.9	8.7	6.2	9.0	6.2	9.3	6.2	9.8	6.1	10.3	6.0
	20	7.4	5.5	8.2	5.9	8.7	6.2	9.0	6.2	9.3	6.2	9.8	6.1	10.3	6.0
	21	7.4	5.5	8.2	5.9	8.7	6.2	9.0	6.2	9.3	6.2	9.8	6.1	10.3	6.0
	23	7.4	5.5	8.2	5.9	8.7	6.2	9.0	6.2	9.3	6.2	9.8	6.1	10.3	6.0
	25	7.4	5.5	8.2	5.9	8.7	6.2	9.0	6.2	9.3	6.2	9.8	6.1	10.3	6.0
	27	7.4	5.5	8.2	5.9	8.7	6.2	9.0	6.2	9.3	6.2	9.8	6.1	10.3	6.0
	29	7.4	5.5	8.2	5.9	8.7	6.2	9.0	6.2	9.3	6.2	9.8	6.1	10.3	6.0
	31	7.4	5.5	8.2	5.9	8.7	6.2	9.0	6.2	9.3	6.2	9.8	6.1	10.3	6.0
	33	7.4	5.5	8.2	5.9	8.7	6.2	9.0	6.2	9.3	6.2	9.8	6.1	10.3	6.0
	35	7.4	5.5	8.2	5.9	8.7	6.2	9.0	6.2	9.3	6.2	9.8	6.1	10.3	6.0
	37	7.2	5.4	8.0	5.7	8.5	6.1	8.8	6.0	9.0	6.0	9.6	6.0	10.0	5.9
	39	6.9	5.1	7.7	5.5	8.2	5.8	8.4	5.8	8.7	5.8	9.2	5.8	9.6	5.6
40	6.7	5.0	7.5	5.3	8.0	5.7	8.2	5.7	8.5	5.7	8.9	5.6	9.4	5.5	
42	6.3	4.7	7.0	5.0	7.4	5.3	7.7	5.3	7.9	5.3	8.4	5.2	8.7	5.1	
44	5.8	4.3	6.4	4.6	6.8	4.8	7.0	4.8	7.2	4.8	7.6	4.8	8.0	4.7	
46	5.1	3.8	5.7	4.0	6.0	4.3	6.2	4.3	6.4	4.3	6.8	4.2	7.1	4.1	
036	10	9.2	7.4	10.2	7.9	10.9	8.4	11.2	8.4	11.5	8.4	12.2	8.3	12.8	8.1
	12	9.2	7.4	10.2	7.9	10.9	8.4	11.2	8.4	11.5	8.4	12.2	8.3	12.8	8.1
	14	9.2	7.4	10.2	7.9	10.9	8.4	11.2	8.4	11.5	8.4	12.2	8.3	12.8	8.1
	16	9.2	7.4	10.2	7.9	10.9	8.4	11.2	8.4	11.5	8.4	12.2	8.3	12.8	8.1
	18	9.2	7.4	10.2	7.9	10.9	8.4	11.2	8.4	11.5	8.4	12.2	8.3	12.8	8.1
	20	9.2	7.4	10.2	7.9	10.9	8.4	11.2	8.4	11.5	8.4	12.2	8.3	12.8	8.1
	21	9.2	7.4	10.2	7.9	10.9	8.4	11.2	8.4	11.5	8.4	12.2	8.3	12.8	8.1
	23	9.2	7.4	10.2	7.9	10.9	8.4	11.2	8.4	11.5	8.4	12.2	8.3	12.8	8.1
	25	9.2	7.4	10.2	7.9	10.9	8.4	11.2	8.4	11.5	8.4	12.2	8.3	12.8	8.1
	27	9.2	7.4	10.2	7.9	10.9	8.4	11.2	8.4	11.5	8.4	12.2	8.3	12.8	8.1
	29	9.2	7.4	10.2	7.9	10.9	8.4	11.2	8.4	11.5	8.4	12.2	8.3	12.8	8.1
	31	9.2	7.4	10.2	7.9	10.9	8.4	11.2	8.4	11.5	8.4	12.2	8.3	12.8	8.1
	33	9.2	7.4	10.2	7.9	10.9	8.4	11.2	8.4	11.5	8.4	12.2	8.3	12.8	8.1
	35	9.2	7.4	10.2	7.9	10.9	8.4	11.2	8.4	11.5	8.4	12.2	8.3	12.8	8.1
	37	8.9	7.2	9.9	7.7	10.5	8.2	10.9	8.1	11.2	8.1	11.8	8.1	12.4	7.9
	39	8.5	6.9	9.4	7.4	10.1	7.8	10.4	7.8	10.7	7.8	11.3	7.7	11.8	7.5
40	8.3	6.7	9.2	7.1	9.8	7.6	10.1	7.6	10.4	7.6	11.0	7.5	11.5	7.3	
42	7.7	6.2	8.5	6.6	9.1	7.1	9.4	7.0	9.7	7.0	10.2	7.0	10.7	6.8	
44	7.0	5.7	7.7	6.0	8.3	6.4	8.5	6.4	8.8	6.4	9.3	6.3	9.7	6.2	
46	6.2	5.0	6.8	5.3	7.3	5.7	7.5	5.6	7.8	5.6	8.2	5.6	8.6	5.5	



2-way Air Discharge Cassette Type (MMU-AP___2WH)

TC : Total capacity [kW] SHC : Sensible capacity [kW]

unit size	outdoor air temp. °CDB	indoor air temp.													
		14°CWB		16°CWB		18°CWB		19°CWB		20°CWB		22°CWB		24°CWB	
		20°CDB		23°CDB		26°CDB		27°CDB		28°CDB		30°CDB		32°CDB	
		TC	SHC	TC	SHC	TC	SHC	TC	SHC	TC	SHC	TC	SHC	TC	SHC
048	10	11.5	8.6	12.7	9.2	13.6	9.7	14.0	9.7	14.4	9.7	15.3	9.6	16.0	9.4
	12	11.5	8.6	12.7	9.2	13.6	9.7	14.0	9.7	14.4	9.7	15.3	9.6	16.0	9.4
	14	11.5	8.6	12.7	9.2	13.6	9.7	14.0	9.7	14.4	9.7	15.3	9.6	16.0	9.4
	16	11.5	8.6	12.7	9.2	13.6	9.7	14.0	9.7	14.4	9.7	15.3	9.6	16.0	9.4
	18	11.5	8.6	12.7	9.2	13.6	9.7	14.0	9.7	14.4	9.7	15.3	9.6	16.0	9.4
	20	11.5	8.6	12.7	9.2	13.6	9.7	14.0	9.7	14.4	9.7	15.3	9.6	16.0	9.4
	21	11.5	8.6	12.7	9.2	13.6	9.7	14.0	9.7	14.4	9.7	15.3	9.6	16.0	9.4
	23	11.5	8.6	12.7	9.2	13.6	9.7	14.0	9.7	14.4	9.7	15.3	9.6	16.0	9.4
	25	11.5	8.6	12.7	9.2	13.6	9.7	14.0	9.7	14.4	9.7	15.3	9.6	16.0	9.4
	27	11.5	8.6	12.7	9.2	13.6	9.7	14.0	9.7	14.4	9.7	15.3	9.6	16.0	9.4
	29	11.5	8.6	12.7	9.2	13.6	9.7	14.0	9.7	14.4	9.7	15.3	9.6	16.0	9.4
	31	11.5	8.6	12.7	9.2	13.6	9.7	14.0	9.7	14.4	9.7	15.3	9.6	16.0	9.4
	33	11.5	8.6	12.7	9.2	13.6	9.7	14.0	9.7	14.4	9.7	15.3	9.6	16.0	9.4
	35	11.5	8.6	12.7	9.2	13.6	9.7	14.0	9.7	14.4	9.7	15.3	9.6	16.0	9.4
	37	11.1	8.3	12.3	8.9	13.2	9.4	13.6	9.4	14.0	9.4	14.8	9.3	15.5	9.1
	39	10.7	8.0	11.8	8.5	12.6	9.0	13.0	9.0	13.4	9.0	14.1	8.9	14.8	8.7
	40	10.3	7.7	11.4	8.2	12.2	8.8	12.6	8.7	13.0	8.7	13.7	8.6	14.4	8.4
42	9.6	7.2	10.6	7.7	11.4	8.1	11.7	8.1	12.1	8.1	12.8	8.0	13.4	7.9	
44	8.8	6.5	9.7	7.0	10.3	7.4	10.7	7.4	11.0	7.4	11.6	7.3	12.2	7.1	
46	7.7	5.8	8.5	6.2	9.1	6.5	9.4	6.5	9.7	6.5	10.3	6.5	10.7	6.3	
056	10	13.1	9.7	14.5	10.3	15.5	10.9	16.0	10.9	16.5	10.9	17.4	10.8	18.2	10.5
	12	13.1	9.7	14.5	10.3	15.5	10.9	16.0	10.9	16.5	10.9	17.4	10.8	18.2	10.5
	14	13.1	9.7	14.5	10.3	15.5	10.9	16.0	10.9	16.5	10.9	17.4	10.8	18.2	10.5
	16	13.1	9.7	14.5	10.3	15.5	10.9	16.0	10.9	16.5	10.9	17.4	10.8	18.2	10.5
	18	13.1	9.7	14.5	10.3	15.5	10.9	16.0	10.9	16.5	10.9	17.4	10.8	18.2	10.5
	20	13.1	9.7	14.5	10.3	15.5	10.9	16.0	10.9	16.5	10.9	17.4	10.8	18.2	10.5
	21	13.1	9.7	14.5	10.3	15.5	10.9	16.0	10.9	16.5	10.9	17.4	10.8	18.2	10.5
	23	13.1	9.7	14.5	10.3	15.5	10.9	16.0	10.9	16.5	10.9	17.4	10.8	18.2	10.5
	25	13.1	9.7	14.5	10.3	15.5	10.9	16.0	10.9	16.5	10.9	17.4	10.8	18.2	10.5
	27	13.1	9.7	14.5	10.3	15.5	10.9	16.0	10.9	16.5	10.9	17.4	10.8	18.2	10.5
	29	13.1	9.7	14.5	10.3	15.5	10.9	16.0	10.9	16.5	10.9	17.4	10.8	18.2	10.5
	31	13.1	9.7	14.5	10.3	15.5	10.9	16.0	10.9	16.5	10.9	17.4	10.8	18.2	10.5
	33	13.1	9.7	14.5	10.3	15.5	10.9	16.0	10.9	16.5	10.9	17.4	10.8	18.2	10.5
	35	13.1	9.7	14.5	10.3	15.5	10.9	16.0	10.9	16.5	10.9	17.4	10.8	18.2	10.5
	37	12.7	9.4	14.1	10.0	15.1	10.6	15.5	10.6	16.0	10.6	16.9	10.5	17.7	10.2
	39	12.2	9.0	13.5	9.5	14.4	10.1	14.8	10.1	15.3	10.1	16.2	10.0	16.9	9.8
	40	11.8	8.7	13.1	9.3	14.0	9.8	14.4	9.8	14.8	9.8	15.7	9.7	16.4	9.5
42	11.0	8.1	12.2	8.6	13.0	9.2	13.4	9.1	13.8	9.1	14.6	9.0	15.3	8.8	
44	10.0	7.4	11.1	7.8	11.8	8.3	12.2	8.3	12.5	8.3	13.3	8.2	13.9	8.0	
46	8.8	6.5	9.8	6.9	10.4	7.4	10.8	7.3	11.1	7.3	11.7	7.3	12.3	7.1	



1-way Air Discharge Cassette Type (MMU-AP___4YH-E)

TC : Total capacity [kW] SHC : Sensible capacity [kW]

unit size	outdoor air temp. °CDB	indoor air temp.													
		14°CWB		16°CWB		18°CWB		19°CWB		20°CWB		22°CWB		24°CWB	
		20°CDB	23°CDB	26°CDB	27°CDB	28°CDB	30°CDB	32°CDB	TC	SHC	TC	SHC	TC	SHC	TC
007	10	1.8	1.6	2.0	1.7	2.1	1.8	2.2	1.8	2.3	1.8	2.4	1.8	2.5	1.7
	12	1.8	1.6	2.0	1.7	2.1	1.8	2.2	1.8	2.3	1.8	2.4	1.8	2.5	1.7
	14	1.8	1.6	2.0	1.7	2.1	1.8	2.2	1.8	2.3	1.8	2.4	1.8	2.5	1.7
	16	1.8	1.6	2.0	1.7	2.1	1.8	2.2	1.8	2.3	1.8	2.4	1.8	2.5	1.7
	18	1.8	1.6	2.0	1.7	2.1	1.8	2.2	1.8	2.3	1.8	2.4	1.8	2.5	1.7
	20	1.8	1.6	2.0	1.7	2.1	1.8	2.2	1.8	2.3	1.8	2.4	1.8	2.5	1.7
	21	1.8	1.6	2.0	1.7	2.1	1.8	2.2	1.8	2.3	1.8	2.4	1.8	2.5	1.7
	23	1.8	1.6	2.0	1.7	2.1	1.8	2.2	1.8	2.3	1.8	2.4	1.8	2.5	1.7
	25	1.8	1.6	2.0	1.7	2.1	1.8	2.2	1.8	2.3	1.8	2.4	1.8	2.5	1.7
	27	1.8	1.6	2.0	1.7	2.1	1.8	2.2	1.8	2.3	1.8	2.4	1.8	2.5	1.7
	29	1.8	1.6	2.0	1.7	2.1	1.8	2.2	1.8	2.3	1.8	2.4	1.8	2.5	1.7
	31	1.8	1.6	2.0	1.7	2.1	1.8	2.2	1.8	2.3	1.8	2.4	1.8	2.5	1.7
	33	1.8	1.6	2.0	1.7	2.1	1.8	2.2	1.8	2.3	1.8	2.4	1.8	2.5	1.7
	35	1.8	1.6	2.0	1.7	2.1	1.8	2.2	1.8	2.3	1.8	2.4	1.8	2.5	1.7
	37	1.8	1.5	1.9	1.6	2.1	1.8	2.1	1.7	2.2	1.7	2.3	1.7	2.4	1.7
	39	1.7	1.5	1.9	1.6	2.0	1.7	2.0	1.7	2.1	1.7	2.2	1.7	2.3	1.6
40	1.6	1.4	1.8	1.5	1.9	1.6	2.0	1.6	2.0	1.6	2.2	1.6	2.3	1.6	
42	1.5	1.3	1.7	1.4	1.8	1.5	1.8	1.5	1.9	1.5	2.0	1.5	2.1	1.5	
44	1.4	1.2	1.5	1.3	1.6	1.4	1.7	1.4	1.7	1.4	1.8	1.4	1.9	1.3	
46	1.2	1.1	1.3	1.1	1.4	1.2	1.5	1.2	1.5	1.2	1.6	1.2	1.7	1.2	
009	10	2.3	2.0	2.5	2.1	2.7	2.3	2.8	2.3	2.9	2.2	3.1	2.2	3.2	2.2
	12	2.3	2.0	2.5	2.1	2.7	2.3	2.8	2.3	2.9	2.2	3.1	2.2	3.2	2.2
	14	2.3	2.0	2.5	2.1	2.7	2.3	2.8	2.3	2.9	2.2	3.1	2.2	3.2	2.2
	16	2.3	2.0	2.5	2.1	2.7	2.3	2.8	2.3	2.9	2.2	3.1	2.2	3.2	2.2
	18	2.3	2.0	2.5	2.1	2.7	2.3	2.8	2.3	2.9	2.2	3.1	2.2	3.2	2.2
	20	2.3	2.0	2.5	2.1	2.7	2.3	2.8	2.3	2.9	2.2	3.1	2.2	3.2	2.2
	21	2.3	2.0	2.5	2.1	2.7	2.3	2.8	2.3	2.9	2.2	3.1	2.2	3.2	2.2
	23	2.3	2.0	2.5	2.1	2.7	2.3	2.8	2.3	2.9	2.2	3.1	2.2	3.2	2.2
	25	2.3	2.0	2.5	2.1	2.7	2.3	2.8	2.3	2.9	2.2	3.1	2.2	3.2	2.2
	27	2.3	2.0	2.5	2.1	2.7	2.3	2.8	2.3	2.9	2.2	3.1	2.2	3.2	2.2
	29	2.3	2.0	2.5	2.1	2.7	2.3	2.8	2.3	2.9	2.2	3.1	2.2	3.2	2.2
	31	2.3	2.0	2.5	2.1	2.7	2.3	2.8	2.3	2.9	2.2	3.1	2.2	3.2	2.2
	33	2.3	2.0	2.5	2.1	2.7	2.3	2.8	2.3	2.9	2.2	3.1	2.2	3.2	2.2
	35	2.3	2.0	2.5	2.1	2.7	2.3	2.8	2.3	2.9	2.2	3.1	2.2	3.2	2.2
	37	2.2	1.9	2.5	2.1	2.6	2.2	2.7	2.2	2.8	2.2	3.0	2.2	3.1	2.1
	39	2.1	1.8	2.4	2.0	2.5	2.1	2.6	2.1	2.7	2.1	2.8	2.1	3.0	2.0
40	2.1	1.8	2.3	1.9	2.4	2.0	2.5	2.0	2.6	2.0	2.7	2.0	2.9	2.0	
42	1.9	1.7	2.1	1.8	2.3	1.9	2.3	1.9	2.4	1.9	2.6	1.9	2.7	1.8	
44	1.8	1.5	1.9	1.6	2.1	1.7	2.1	1.7	2.2	1.7	2.3	1.7	2.4	1.7	
46	1.5	1.3	1.7	1.4	1.8	1.5	1.9	1.5	1.9	1.5	2.1	1.5	2.1	1.5	
012	10	3.0	2.5	3.3	2.6	3.5	2.8	3.6	2.8	3.7	2.8	3.9	2.8	4.1	2.7
	12	3.0	2.5	3.3	2.6	3.5	2.8	3.6	2.8	3.7	2.8	3.9	2.8	4.1	2.7
	14	3.0	2.5	3.3	2.6	3.5	2.8	3.6	2.8	3.7	2.8	3.9	2.8	4.1	2.7
	16	3.0	2.5	3.3	2.6	3.5	2.8	3.6	2.8	3.7	2.8	3.9	2.8	4.1	2.7
	18	3.0	2.5	3.3	2.6	3.5	2.8	3.6	2.8	3.7	2.8	3.9	2.8	4.1	2.7
	20	3.0	2.5	3.3	2.6	3.5	2.8	3.6	2.8	3.7	2.8	3.9	2.8	4.1	2.7
	21	3.0	2.5	3.3	2.6	3.5	2.8	3.6	2.8	3.7	2.8	3.9	2.8	4.1	2.7
	23	3.0	2.5	3.3	2.6	3.5	2.8	3.6	2.8	3.7	2.8	3.9	2.8	4.1	2.7
	25	3.0	2.5	3.3	2.6	3.5	2.8	3.6	2.8	3.7	2.8	3.9	2.8	4.1	2.7
	27	3.0	2.5	3.3	2.6	3.5	2.8	3.6	2.8	3.7	2.8	3.9	2.8	4.1	2.7
	29	3.0	2.5	3.3	2.6	3.5	2.8	3.6	2.8	3.7	2.8	3.9	2.8	4.1	2.7
	31	3.0	2.5	3.3	2.6	3.5	2.8	3.6	2.8	3.7	2.8	3.9	2.8	4.1	2.7
	33	3.0	2.5	3.3	2.6	3.5	2.8	3.6	2.8	3.7	2.8	3.9	2.8	4.1	2.7
	35	3.0	2.5	3.3	2.6	3.5	2.8	3.6	2.8	3.7	2.8	3.9	2.8	4.1	2.7
	37	2.9	2.4	3.2	2.6	3.4	2.7	3.5	2.7	3.6	2.7	3.8	2.7	4.0	2.6
	39	2.7	2.3	3.0	2.5	3.2	2.6	3.3	2.6	3.4	2.6	3.6	2.6	3.8	2.5
40	2.7	2.2	2.9	2.4	3.1	2.5	3.2	2.5	3.3	2.5	3.5	2.5	3.7	2.4	
42	2.5	2.1	2.7	2.2	2.9	2.4	3.0	2.3	3.1	2.3	3.3	2.3	3.4	2.3	
44	2.3	1.9	2.5	2.0	2.7	2.1	2.7	2.1	2.8	2.1	3.0	2.1	3.1	2.1	
46	2.0	1.7	2.2	1.8	2.3	1.9	2.4	1.9	2.5	1.9	2.6	1.9	2.8	1.8	



1-way Air Discharge Cassette Type (MMU-AP___4SH-E)

TC : Total capacity [kW] SHC : Sensible capacity [kW]

unit size	outdoor air temp. °CDB	indoor air temp.													
		14°CWB		16°CWB		18°CWB		19°CWB		20°CWB		22°CWB		24°CWB	
		20°CDB	23°CDB	26°CDB	27°CDB	28°CDB	30°CDB	32°CDB	TC	SHC	TC	SHC	TC	SHC	
015	10	3.7	3.0	4.1	3.2	4.4	3.4	4.5	3.4	4.6	3.4	4.9	3.4	5.1	3.3
	12	3.7	3.0	4.1	3.2	4.4	3.4	4.5	3.4	4.6	3.4	4.9	3.4	5.1	3.3
	14	3.7	3.0	4.1	3.2	4.4	3.4	4.5	3.4	4.6	3.4	4.9	3.4	5.1	3.3
	16	3.7	3.0	4.1	3.2	4.4	3.4	4.5	3.4	4.6	3.4	4.9	3.4	5.1	3.3
	18	3.7	3.0	4.1	3.2	4.4	3.4	4.5	3.4	4.6	3.4	4.9	3.4	5.1	3.3
	20	3.7	3.0	4.1	3.2	4.4	3.4	4.5	3.4	4.6	3.4	4.9	3.4	5.1	3.3
	21	3.7	3.0	4.1	3.2	4.4	3.4	4.5	3.4	4.6	3.4	4.9	3.4	5.1	3.3
	23	3.7	3.0	4.1	3.2	4.4	3.4	4.5	3.4	4.6	3.4	4.9	3.4	5.1	3.3
	25	3.7	3.0	4.1	3.2	4.4	3.4	4.5	3.4	4.6	3.4	4.9	3.4	5.1	3.3
	27	3.7	3.0	4.1	3.2	4.4	3.4	4.5	3.4	4.6	3.4	4.9	3.4	5.1	3.3
	29	3.7	3.0	4.1	3.2	4.4	3.4	4.5	3.4	4.6	3.4	4.9	3.4	5.1	3.3
	31	3.7	3.0	4.1	3.2	4.4	3.4	4.5	3.4	4.6	3.4	4.9	3.4	5.1	3.3
	33	3.7	3.0	4.1	3.2	4.4	3.4	4.5	3.4	4.6	3.4	4.9	3.4	5.1	3.3
	35	3.7	3.0	4.1	3.2	4.4	3.4	4.5	3.4	4.6	3.4	4.9	3.4	5.1	3.3
	37	3.6	2.9	4.0	3.1	4.2	3.3	4.4	3.3	4.5	3.3	4.8	3.3	5.0	3.2
	39	3.4	2.8	3.8	3.0	4.0	3.2	4.2	3.2	4.3	3.2	4.5	3.1	4.8	3.0
40	3.3	2.7	3.7	2.9	3.9	3.1	4.1	3.1	4.2	3.1	4.4	3.0	4.6	3.0	
42	3.1	2.5	3.4	2.7	3.7	2.9	3.8	2.8	3.9	2.8	4.1	2.8	4.3	2.8	
44	2.8	2.3	3.1	2.4	3.3	2.6	3.4	2.6	3.5	2.6	3.7	2.6	3.9	2.5	
46	2.5	2.0	2.7	2.2	2.9	2.3	3.0	2.3	3.1	2.3	3.3	2.3	3.4	2.2	
018	10	4.6	3.5	5.1	3.8	5.4	4.0	5.6	4.0	5.8	4.0	6.1	4.0	6.4	3.9
	12	4.6	3.5	5.1	3.8	5.4	4.0	5.6	4.0	5.8	4.0	6.1	4.0	6.4	3.9
	14	4.6	3.5	5.1	3.8	5.4	4.0	5.6	4.0	5.8	4.0	6.1	4.0	6.4	3.9
	16	4.6	3.5	5.1	3.8	5.4	4.0	5.6	4.0	5.8	4.0	6.1	4.0	6.4	3.9
	18	4.6	3.5	5.1	3.8	5.4	4.0	5.6	4.0	5.8	4.0	6.1	4.0	6.4	3.9
	20	4.6	3.5	5.1	3.8	5.4	4.0	5.6	4.0	5.8	4.0	6.1	4.0	6.4	3.9
	21	4.6	3.5	5.1	3.8	5.4	4.0	5.6	4.0	5.8	4.0	6.1	4.0	6.4	3.9
	23	4.6	3.5	5.1	3.8	5.4	4.0	5.6	4.0	5.8	4.0	6.1	4.0	6.4	3.9
	25	4.6	3.5	5.1	3.8	5.4	4.0	5.6	4.0	5.8	4.0	6.1	4.0	6.4	3.9
	27	4.6	3.5	5.1	3.8	5.4	4.0	5.6	4.0	5.8	4.0	6.1	4.0	6.4	3.9
	29	4.6	3.5	5.1	3.8	5.4	4.0	5.6	4.0	5.8	4.0	6.1	4.0	6.4	3.9
	31	4.6	3.5	5.1	3.8	5.4	4.0	5.6	4.0	5.8	4.0	6.1	4.0	6.4	3.9
	33	4.6	3.5	5.1	3.8	5.4	4.0	5.6	4.0	5.8	4.0	6.1	4.0	6.4	3.9
	35	4.6	3.5	5.1	3.8	5.4	4.0	5.6	4.0	5.8	4.0	6.1	4.0	6.4	3.9
	37	4.5	3.4	4.9	3.7	5.3	3.9	5.4	3.9	5.6	3.9	5.9	3.8	6.2	3.8
	39	4.3	3.3	4.7	3.5	5.0	3.7	5.2	3.7	5.3	3.7	5.7	3.7	5.9	3.6
40	4.1	3.2	4.6	3.4	4.9	3.6	5.0	3.6	5.2	3.6	5.5	3.6	5.7	3.5	
42	3.8	3.0	4.3	3.2	4.5	3.4	4.7	3.3	4.8	3.3	5.1	3.3	5.3	3.2	
44	3.5	2.7	3.9	2.9	4.1	3.1	4.3	3.0	4.4	3.0	4.6	3.0	4.9	2.9	
46	3.1	2.4	3.4	2.5	3.7	2.7	3.8	2.7	3.9	2.7	4.1	2.7	4.3	2.6	
024	10	5.8	4.4	6.4	4.7	6.9	5.0	7.1	5.0	7.3	5.0	7.7	5.0	8.1	4.8
	12	5.8	4.4	6.4	4.7	6.9	5.0	7.1	5.0	7.3	5.0	7.7	5.0	8.1	4.8
	14	5.8	4.4	6.4	4.7	6.9	5.0	7.1	5.0	7.3	5.0	7.7	5.0	8.1	4.8
	16	5.8	4.4	6.4	4.7	6.9	5.0	7.1	5.0	7.3	5.0	7.7	5.0	8.1	4.8
	18	5.8	4.4	6.4	4.7	6.9	5.0	7.1	5.0	7.3	5.0	7.7	5.0	8.1	4.8
	20	5.8	4.4	6.4	4.7	6.9	5.0	7.1	5.0	7.3	5.0	7.7	5.0	8.1	4.8
	21	5.8	4.4	6.4	4.7	6.9	5.0	7.1	5.0	7.3	5.0	7.7	5.0	8.1	4.8
	23	5.8	4.4	6.4	4.7	6.9	5.0	7.1	5.0	7.3	5.0	7.7	5.0	8.1	4.8
	25	5.8	4.4	6.4	4.7	6.9	5.0	7.1	5.0	7.3	5.0	7.7	5.0	8.1	4.8
	27	5.8	4.4	6.4	4.7	6.9	5.0	7.1	5.0	7.3	5.0	7.7	5.0	8.1	4.8
	29	5.8	4.4	6.4	4.7	6.9	5.0	7.1	5.0	7.3	5.0	7.7	5.0	8.1	4.8
	31	5.8	4.4	6.4	4.7	6.9	5.0	7.1	5.0	7.3	5.0	7.7	5.0	8.1	4.8
	33	5.8	4.4	6.4	4.7	6.9	5.0	7.1	5.0	7.3	5.0	7.7	5.0	8.1	4.8
	35	5.8	4.4	6.4	4.7	6.9	5.0	7.1	5.0	7.3	5.0	7.7	5.0	8.1	4.8
	37	5.7	4.3	6.3	4.6	6.7	4.9	6.9	4.9	7.1	4.8	7.5	4.8	7.9	4.7
	39	5.4	4.1	6.0	4.4	6.4	4.6	6.6	4.6	6.8	4.6	7.2	4.6	7.5	4.5
40	5.2	4.0	5.8	4.2	6.2	4.5	6.4	4.5	6.6	4.5	7.0	4.5	7.3	4.4	
42	4.9	3.7	5.4	4.0	5.8	4.2	5.9	4.2	6.1	4.2	6.5	4.1	6.8	4.1	
44	4.4	3.4	4.9	3.6	5.2	3.8	5.4	3.8	5.6	3.8	5.9	3.8	6.2	3.7	
46	3.9	3.0	4.3	3.2	4.6	3.4	4.8	3.4	4.9	3.4	5.2	3.3	5.4	3.3	



Concealed Duct Standard Type (MMD-AP___ 6BHP-E)

TC : Total capacity [kW] SHC : Sensible capacity [kW]

unit size	outdoor air temp. °CDB	indoor air temp.													
		14°CWB		16°CWB		18°CWB		19°CWB		20°CWB		22°CWB		24°CWB	
		20°CDB	23°CDB	26°CDB	27°CDB	28°CDB	30°CDB	32°CDB	TC	SHC	TC	SHC	TC	SHC	TC
007	10	1.8	1.6	2.0	1.7	2.1	1.8	2.2	1.8	2.3	1.8	2.4	1.8	2.5	1.7
	12	1.8	1.6	2.0	1.7	2.1	1.8	2.2	1.8	2.3	1.8	2.4	1.8	2.5	1.7
	14	1.8	1.6	2.0	1.7	2.1	1.8	2.2	1.8	2.3	1.8	2.4	1.8	2.5	1.7
	16	1.8	1.6	2.0	1.7	2.1	1.8	2.2	1.8	2.3	1.8	2.4	1.8	2.5	1.7
	18	1.8	1.6	2.0	1.7	2.1	1.8	2.2	1.8	2.3	1.8	2.4	1.8	2.5	1.7
	20	1.8	1.6	2.0	1.7	2.1	1.8	2.2	1.8	2.3	1.8	2.4	1.8	2.5	1.7
	21	1.8	1.6	2.0	1.7	2.1	1.8	2.2	1.8	2.3	1.8	2.4	1.8	2.5	1.7
	23	1.8	1.6	2.0	1.7	2.1	1.8	2.2	1.8	2.3	1.8	2.4	1.8	2.5	1.7
	25	1.8	1.6	2.0	1.7	2.1	1.8	2.2	1.8	2.3	1.8	2.4	1.8	2.5	1.7
	27	1.8	1.6	2.0	1.7	2.1	1.8	2.2	1.8	2.3	1.8	2.4	1.8	2.5	1.7
	29	1.8	1.6	2.0	1.7	2.1	1.8	2.2	1.8	2.3	1.8	2.4	1.8	2.5	1.7
	31	1.8	1.6	2.0	1.7	2.1	1.8	2.2	1.8	2.3	1.8	2.4	1.8	2.5	1.7
	33	1.8	1.6	2.0	1.7	2.1	1.8	2.2	1.8	2.3	1.8	2.4	1.8	2.5	1.7
	35	1.8	1.6	2.0	1.7	2.1	1.8	2.2	1.8	2.3	1.8	2.4	1.8	2.5	1.7
	37	1.8	1.5	1.9	1.6	2.1	1.8	2.1	1.7	2.2	1.7	2.3	1.7	2.4	1.7
	39	1.7	1.5	1.9	1.6	2.0	1.7	2.0	1.7	2.1	1.7	2.2	1.7	2.3	1.6
	40	1.6	1.4	1.8	1.5	1.9	1.6	2.0	1.6	2.0	1.6	2.2	1.6	2.3	1.6
42	1.5	1.3	1.7	1.4	1.8	1.5	1.8	1.5	1.9	1.5	2.0	1.5	2.1	1.5	
44	1.4	1.2	1.5	1.3	1.6	1.4	1.7	1.4	1.7	1.4	1.8	1.4	1.9	1.3	
46	1.2	1.1	1.3	1.1	1.4	1.2	1.5	1.2	1.5	1.2	1.6	1.2	1.7	1.2	
009	10	2.3	2.0	2.5	2.2	2.7	2.3	2.8	2.3	2.9	2.3	3.1	2.3	3.2	2.2
	12	2.3	2.0	2.5	2.2	2.7	2.3	2.8	2.3	2.9	2.3	3.1	2.3	3.2	2.2
	14	2.3	2.0	2.5	2.2	2.7	2.3	2.8	2.3	2.9	2.3	3.1	2.3	3.2	2.2
	16	2.3	2.0	2.5	2.2	2.7	2.3	2.8	2.3	2.9	2.3	3.1	2.3	3.2	2.2
	18	2.3	2.0	2.5	2.2	2.7	2.3	2.8	2.3	2.9	2.3	3.1	2.3	3.2	2.2
	20	2.3	2.0	2.5	2.2	2.7	2.3	2.8	2.3	2.9	2.3	3.1	2.3	3.2	2.2
	21	2.3	2.0	2.5	2.2	2.7	2.3	2.8	2.3	2.9	2.3	3.1	2.3	3.2	2.2
	23	2.3	2.0	2.5	2.2	2.7	2.3	2.8	2.3	2.9	2.3	3.1	2.3	3.2	2.2
	25	2.3	2.0	2.5	2.2	2.7	2.3	2.8	2.3	2.9	2.3	3.1	2.3	3.2	2.2
	27	2.3	2.0	2.5	2.2	2.7	2.3	2.8	2.3	2.9	2.3	3.1	2.3	3.2	2.2
	29	2.3	2.0	2.5	2.2	2.7	2.3	2.8	2.3	2.9	2.3	3.1	2.3	3.2	2.2
	31	2.3	2.0	2.5	2.2	2.7	2.3	2.8	2.3	2.9	2.3	3.1	2.3	3.2	2.2
	33	2.3	2.0	2.5	2.2	2.7	2.3	2.8	2.3	2.9	2.3	3.1	2.3	3.2	2.2
	35	2.3	2.0	2.5	2.2	2.7	2.3	2.8	2.3	2.9	2.3	3.1	2.3	3.2	2.2
	37	2.2	2.0	2.5	2.1	2.6	2.2	2.7	2.2	2.8	2.2	3.0	2.2	3.1	2.2
	39	2.1	1.9	2.4	2.0	2.5	2.1	2.6	2.1	2.7	2.1	2.8	2.1	3.0	2.1
	40	2.1	1.8	2.3	2.0	2.4	2.1	2.5	2.1	2.6	2.1	2.7	2.1	2.9	2.0
42	1.9	1.7	2.1	1.8	2.3	1.9	2.3	1.9	2.4	1.9	2.6	1.9	2.7	1.9	
44	1.8	1.6	1.9	1.7	2.1	1.8	2.1	1.8	2.2	1.8	2.3	1.7	2.4	1.7	
46	1.5	1.4	1.7	1.5	1.8	1.6	1.9	1.5	1.9	1.5	2.1	1.5	2.1	1.5	
012	10	3.0	2.4	3.3	2.5	3.5	2.7	3.6	2.7	3.7	2.7	3.9	2.7	4.1	2.6
	12	3.0	2.4	3.3	2.5	3.5	2.7	3.6	2.7	3.7	2.7	3.9	2.7	4.1	2.6
	14	3.0	2.4	3.3	2.5	3.5	2.7	3.6	2.7	3.7	2.7	3.9	2.7	4.1	2.6
	16	3.0	2.4	3.3	2.5	3.5	2.7	3.6	2.7	3.7	2.7	3.9	2.7	4.1	2.6
	18	3.0	2.4	3.3	2.5	3.5	2.7	3.6	2.7	3.7	2.7	3.9	2.7	4.1	2.6
	20	3.0	2.4	3.3	2.5	3.5	2.7	3.6	2.7	3.7	2.7	3.9	2.7	4.1	2.6
	21	3.0	2.4	3.3	2.5	3.5	2.7	3.6	2.7	3.7	2.7	3.9	2.7	4.1	2.6
	23	3.0	2.4	3.3	2.5	3.5	2.7	3.6	2.7	3.7	2.7	3.9	2.7	4.1	2.6
	25	3.0	2.4	3.3	2.5	3.5	2.7	3.6	2.7	3.7	2.7	3.9	2.7	4.1	2.6
	27	3.0	2.4	3.3	2.5	3.5	2.7	3.6	2.7	3.7	2.7	3.9	2.7	4.1	2.6
	29	3.0	2.4	3.3	2.5	3.5	2.7	3.6	2.7	3.7	2.7	3.9	2.7	4.1	2.6
	31	3.0	2.4	3.3	2.5	3.5	2.7	3.6	2.7	3.7	2.7	3.9	2.7	4.1	2.6
	33	3.0	2.4	3.3	2.5	3.5	2.7	3.6	2.7	3.7	2.7	3.9	2.7	4.1	2.6
	35	3.0	2.4	3.3	2.5	3.5	2.7	3.6	2.7	3.7	2.7	3.9	2.7	4.1	2.6
	37	2.9	2.3	3.2	2.5	3.4	2.6	3.5	2.6	3.6	2.6	3.8	2.6	4.0	2.5
	39	2.7	2.2	3.0	2.4	3.2	2.5	3.3	2.5	3.4	2.5	3.6	2.5	3.8	2.4
	40	2.7	2.2	2.9	2.3	3.1	2.4	3.2	2.4	3.3	2.4	3.5	2.4	3.7	2.4
42	2.5	2.0	2.7	2.1	2.9	2.3	3.0	2.3	3.1	2.3	3.3	2.2	3.4	2.2	
44	2.3	1.8	2.5	1.9	2.7	2.1	2.7	2.1	2.8	2.1	3.0	2.0	3.1	2.0	
46	2.0	1.6	2.2	1.7	2.3	1.8	2.4	1.8	2.5	1.8	2.6	1.8	2.8	1.8	



Concealed Duct Standard Type (MMD-AP__6BHP-E)

TC : Total capacity [kW] SHC : Sensible capacity [kW]

unit size	outdoor air temp. °CDB	indoor air temp.													
		14°CWB		16°CWB		18°CWB		19°CWB		20°CWB		22°CWB		24°CWB	
		20°CDB	23°CDB	26°CDB	27°CDB	28°CDB	30°CDB	32°CDB	TC	SHC	TC	SHC	TC	SHC	TC
015	10	3.7	3.2	4.1	3.4	4.4	3.6	4.5	3.6	4.6	3.6	4.9	3.6	5.1	3.5
	12	3.7	3.2	4.1	3.4	4.4	3.6	4.5	3.6	4.6	3.6	4.9	3.6	5.1	3.5
	14	3.7	3.2	4.1	3.4	4.4	3.6	4.5	3.6	4.6	3.6	4.9	3.6	5.1	3.5
	16	3.7	3.2	4.1	3.4	4.4	3.6	4.5	3.6	4.6	3.6	4.9	3.6	5.1	3.5
	18	3.7	3.2	4.1	3.4	4.4	3.6	4.5	3.6	4.6	3.6	4.9	3.6	5.1	3.5
	20	3.7	3.2	4.1	3.4	4.4	3.6	4.5	3.6	4.6	3.6	4.9	3.6	5.1	3.5
	21	3.7	3.2	4.1	3.4	4.4	3.6	4.5	3.6	4.6	3.6	4.9	3.6	5.1	3.5
	23	3.7	3.2	4.1	3.4	4.4	3.6	4.5	3.6	4.6	3.6	4.9	3.6	5.1	3.5
	25	3.7	3.2	4.1	3.4	4.4	3.6	4.5	3.6	4.6	3.6	4.9	3.6	5.1	3.5
	27	3.7	3.2	4.1	3.4	4.4	3.6	4.5	3.6	4.6	3.6	4.9	3.6	5.1	3.5
	29	3.7	3.2	4.1	3.4	4.4	3.6	4.5	3.6	4.6	3.6	4.9	3.6	5.1	3.5
	31	3.7	3.2	4.1	3.4	4.4	3.6	4.5	3.6	4.6	3.6	4.9	3.6	5.1	3.5
	33	3.7	3.2	4.1	3.4	4.4	3.6	4.5	3.6	4.6	3.6	4.9	3.6	5.1	3.5
	35	3.7	3.2	4.1	3.4	4.4	3.6	4.5	3.6	4.6	3.6	4.9	3.6	5.1	3.5
	37	3.6	3.1	4.0	3.3	4.2	3.5	4.4	3.5	4.5	3.5	4.8	3.5	5.0	3.4
	39	3.4	3.0	3.8	3.2	4.0	3.3	4.2	3.3	4.3	3.3	4.5	3.3	4.8	3.2
40	3.3	2.9	3.7	3.1	3.9	3.2	4.1	3.2	4.2	3.2	4.4	3.2	4.6	3.1	
42	3.1	2.7	3.4	2.8	3.7	3.0	3.8	3.0	3.9	3.0	4.1	3.0	4.3	2.9	
44	2.8	2.4	3.1	2.6	3.3	2.7	3.4	2.7	3.5	2.7	3.7	2.7	3.9	2.7	
46	2.5	2.1	2.7	2.3	2.9	2.4	3.0	2.4	3.1	2.4	3.3	2.4	3.4	2.3	
018	10	4.6	3.7	5.1	4.0	5.4	4.2	5.6	4.2	5.8	4.2	6.1	4.2	6.4	4.1
	12	4.6	3.7	5.1	4.0	5.4	4.2	5.6	4.2	5.8	4.2	6.1	4.2	6.4	4.1
	14	4.6	3.7	5.1	4.0	5.4	4.2	5.6	4.2	5.8	4.2	6.1	4.2	6.4	4.1
	16	4.6	3.7	5.1	4.0	5.4	4.2	5.6	4.2	5.8	4.2	6.1	4.2	6.4	4.1
	18	4.6	3.7	5.1	4.0	5.4	4.2	5.6	4.2	5.8	4.2	6.1	4.2	6.4	4.1
	20	4.6	3.7	5.1	4.0	5.4	4.2	5.6	4.2	5.8	4.2	6.1	4.2	6.4	4.1
	21	4.6	3.7	5.1	4.0	5.4	4.2	5.6	4.2	5.8	4.2	6.1	4.2	6.4	4.1
	23	4.6	3.7	5.1	4.0	5.4	4.2	5.6	4.2	5.8	4.2	6.1	4.2	6.4	4.1
	25	4.6	3.7	5.1	4.0	5.4	4.2	5.6	4.2	5.8	4.2	6.1	4.2	6.4	4.1
	27	4.6	3.7	5.1	4.0	5.4	4.2	5.6	4.2	5.8	4.2	6.1	4.2	6.4	4.1
	29	4.6	3.7	5.1	4.0	5.4	4.2	5.6	4.2	5.8	4.2	6.1	4.2	6.4	4.1
	31	4.6	3.7	5.1	4.0	5.4	4.2	5.6	4.2	5.8	4.2	6.1	4.2	6.4	4.1
	33	4.6	3.7	5.1	4.0	5.4	4.2	5.6	4.2	5.8	4.2	6.1	4.2	6.4	4.1
	35	4.6	3.7	5.1	4.0	5.4	4.2	5.6	4.2	5.8	4.2	6.1	4.2	6.4	4.1
	37	4.5	3.6	4.9	3.8	5.3	4.1	5.4	4.1	5.6	4.1	5.9	4.0	6.2	3.9
	39	4.3	3.5	4.7	3.7	5.0	3.9	5.2	3.9	5.3	3.9	5.7	3.9	5.9	3.8
40	4.1	3.4	4.6	3.6	4.9	3.8	5.0	3.8	5.2	3.8	5.5	3.7	5.7	3.7	
42	3.8	3.1	4.3	3.3	4.5	3.5	4.7	3.5	4.8	3.5	5.1	3.5	5.3	3.4	
44	3.5	2.8	3.9	3.0	4.1	3.2	4.3	3.2	4.4	3.2	4.6	3.2	4.9	3.1	
46	3.1	2.5	3.4	2.7	3.7	2.8	3.8	2.8	3.9	2.8	4.1	2.8	4.3	2.7	
024	10	5.8	4.9	6.4	5.2	6.9	5.5	7.1	5.5	7.3	5.5	7.7	5.4	8.1	5.3
	12	5.8	4.9	6.4	5.2	6.9	5.5	7.1	5.5	7.3	5.5	7.7	5.4	8.1	5.3
	14	5.8	4.9	6.4	5.2	6.9	5.5	7.1	5.5	7.3	5.5	7.7	5.4	8.1	5.3
	16	5.8	4.9	6.4	5.2	6.9	5.5	7.1	5.5	7.3	5.5	7.7	5.4	8.1	5.3
	18	5.8	4.9	6.4	5.2	6.9	5.5	7.1	5.5	7.3	5.5	7.7	5.4	8.1	5.3
	20	5.8	4.9	6.4	5.2	6.9	5.5	7.1	5.5	7.3	5.5	7.7	5.4	8.1	5.3
	21	5.8	4.9	6.4	5.2	6.9	5.5	7.1	5.5	7.3	5.5	7.7	5.4	8.1	5.3
	23	5.8	4.9	6.4	5.2	6.9	5.5	7.1	5.5	7.3	5.5	7.7	5.4	8.1	5.3
	25	5.8	4.9	6.4	5.2	6.9	5.5	7.1	5.5	7.3	5.5	7.7	5.4	8.1	5.3
	27	5.8	4.9	6.4	5.2	6.9	5.5	7.1	5.5	7.3	5.5	7.7	5.4	8.1	5.3
	29	5.8	4.9	6.4	5.2	6.9	5.5	7.1	5.5	7.3	5.5	7.7	5.4	8.1	5.3
	31	5.8	4.9	6.4	5.2	6.9	5.5	7.1	5.5	7.3	5.5	7.7	5.4	8.1	5.3
	33	5.8	4.9	6.4	5.2	6.9	5.5	7.1	5.5	7.3	5.5	7.7	5.4	8.1	5.3
	35	5.8	4.9	6.4	5.2	6.9	5.5	7.1	5.5	7.3	5.5	7.7	5.4	8.1	5.3
	37	5.7	4.7	6.3	5.0	6.7	5.4	6.9	5.3	7.1	5.3	7.5	5.3	7.9	5.2
	39	5.4	4.5	6.0	4.8	6.4	5.1	6.6	5.1	6.8	5.1	7.2	5.0	7.5	4.9
40	5.2	4.4	5.8	4.7	6.2	5.0	6.4	5.0	6.6	5.0	7.0	4.9	7.3	4.8	
42	4.9	4.1	5.4	4.3	5.8	4.6	5.9	4.6	6.1	4.6	6.5	4.6	6.8	4.5	
44	4.4	3.7	4.9	4.0	5.2	4.2	5.4	4.2	5.6	4.2	5.9	4.1	6.2	4.1	
46	3.9	3.3	4.3	3.5	4.6	3.7	4.8	3.7	4.9	3.7	5.2	3.7	5.4	3.6	



Concealed Duct Standard Type (MMD-AP__6BHP-E)

TC : Total capacity [kW] SHC : Sensible capacity [kW]

unit size	outdoor air temp. °CDB	indoor air temp.													
		14°CWB		16°CWB		18°CWB		19°CWB		20°CWB		22°CWB		24°CWB	
		20°CDB	23°CDB	26°CDB	27°CDB	28°CDB	30°CDB	32°CDB	TC	SHC	TC	SHC	TC	SHC	
027	10	6.6	5.4	7.3	5.8	7.8	6.1	8.0	6.1	8.2	6.1	8.7	6.0	9.1	5.9
	12	6.6	5.4	7.3	5.8	7.8	6.1	8.0	6.1	8.2	6.1	8.7	6.0	9.1	5.9
	14	6.6	5.4	7.3	5.8	7.8	6.1	8.0	6.1	8.2	6.1	8.7	6.0	9.1	5.9
	16	6.6	5.4	7.3	5.8	7.8	6.1	8.0	6.1	8.2	6.1	8.7	6.0	9.1	5.9
	18	6.6	5.4	7.3	5.8	7.8	6.1	8.0	6.1	8.2	6.1	8.7	6.0	9.1	5.9
	20	6.6	5.4	7.3	5.8	7.8	6.1	8.0	6.1	8.2	6.1	8.7	6.0	9.1	5.9
	21	6.6	5.4	7.3	5.8	7.8	6.1	8.0	6.1	8.2	6.1	8.7	6.0	9.1	5.9
	23	6.6	5.4	7.3	5.8	7.8	6.1	8.0	6.1	8.2	6.1	8.7	6.0	9.1	5.9
	25	6.6	5.4	7.3	5.8	7.8	6.1	8.0	6.1	8.2	6.1	8.7	6.0	9.1	5.9
	27	6.6	5.4	7.3	5.8	7.8	6.1	8.0	6.1	8.2	6.1	8.7	6.0	9.1	5.9
	29	6.6	5.4	7.3	5.8	7.8	6.1	8.0	6.1	8.2	6.1	8.7	6.0	9.1	5.9
	31	6.6	5.4	7.3	5.8	7.8	6.1	8.0	6.1	8.2	6.1	8.7	6.0	9.1	5.9
	33	6.6	5.4	7.3	5.8	7.8	6.1	8.0	6.1	8.2	6.1	8.7	6.0	9.1	5.9
	35	6.6	5.4	7.3	5.8	7.8	6.1	8.0	6.1	8.2	6.1	8.7	6.0	9.1	5.9
	37	6.4	5.2	7.0	5.6	7.5	5.9	7.8	5.9	8.0	5.9	8.5	5.9	8.8	5.7
	39	6.1	5.0	6.7	5.3	7.2	5.7	7.4	5.7	7.6	5.7	8.1	5.6	8.5	5.5
40	5.9	4.9	6.5	5.2	7.0	5.5	7.2	5.5	7.4	5.5	7.8	5.4	8.2	5.3	
42	5.5	4.5	6.1	4.8	6.5	5.1	6.7	5.1	6.9	5.1	7.3	5.1	7.6	4.9	
44	5.0	4.1	5.5	4.4	5.9	4.7	6.1	4.6	6.3	4.6	6.6	4.6	6.9	4.5	
46	4.4	3.6	4.9	3.9	5.2	4.1	5.4	4.1	5.5	4.1	5.9	4.1	6.1	4.0	
030	10	7.4	5.9	8.2	6.3	8.7	6.7	9.0	6.7	9.3	6.7	9.8	6.6	10.3	6.5
	12	7.4	5.9	8.2	6.3	8.7	6.7	9.0	6.7	9.3	6.7	9.8	6.6	10.3	6.5
	14	7.4	5.9	8.2	6.3	8.7	6.7	9.0	6.7	9.3	6.7	9.8	6.6	10.3	6.5
	16	7.4	5.9	8.2	6.3	8.7	6.7	9.0	6.7	9.3	6.7	9.8	6.6	10.3	6.5
	18	7.4	5.9	8.2	6.3	8.7	6.7	9.0	6.7	9.3	6.7	9.8	6.6	10.3	6.5
	20	7.4	5.9	8.2	6.3	8.7	6.7	9.0	6.7	9.3	6.7	9.8	6.6	10.3	6.5
	21	7.4	5.9	8.2	6.3	8.7	6.7	9.0	6.7	9.3	6.7	9.8	6.6	10.3	6.5
	23	7.4	5.9	8.2	6.3	8.7	6.7	9.0	6.7	9.3	6.7	9.8	6.6	10.3	6.5
	25	7.4	5.9	8.2	6.3	8.7	6.7	9.0	6.7	9.3	6.7	9.8	6.6	10.3	6.5
	27	7.4	5.9	8.2	6.3	8.7	6.7	9.0	6.7	9.3	6.7	9.8	6.6	10.3	6.5
	29	7.4	5.9	8.2	6.3	8.7	6.7	9.0	6.7	9.3	6.7	9.8	6.6	10.3	6.5
	31	7.4	5.9	8.2	6.3	8.7	6.7	9.0	6.7	9.3	6.7	9.8	6.6	10.3	6.5
	33	7.4	5.9	8.2	6.3	8.7	6.7	9.0	6.7	9.3	6.7	9.8	6.6	10.3	6.5
	35	7.4	5.9	8.2	6.3	8.7	6.7	9.0	6.7	9.3	6.7	9.8	6.6	10.3	6.5
	37	7.2	5.8	8.0	6.2	8.5	6.6	8.8	6.5	9.0	6.5	9.6	6.5	10.0	6.3
	39	6.9	5.6	7.7	5.9	8.2	6.3	8.4	6.3	8.7	6.3	9.2	6.2	9.6	6.1
40	6.7	5.4	7.5	5.8	8.0	6.1	8.2	6.1	8.5	6.1	8.9	6.1	9.4	5.9	
42	6.3	5.1	7.0	5.4	7.4	5.7	7.7	5.7	7.9	5.7	8.4	5.7	8.7	5.5	
44	5.8	4.6	6.4	4.9	6.8	5.2	7.0	5.2	7.2	5.2	7.6	5.2	8.0	5.0	
46	5.1	4.1	5.7	4.4	6.0	4.6	6.2	4.6	6.4	4.6	6.8	4.6	7.1	4.5	
036	10	9.2	7.8	10.2	8.3	10.9	8.8	11.2	8.8	11.5	8.8	12.2	8.7	12.8	8.5
	12	9.2	7.8	10.2	8.3	10.9	8.8	11.2	8.8	11.5	8.8	12.2	8.7	12.8	8.5
	14	9.2	7.8	10.2	8.3	10.9	8.8	11.2	8.8	11.5	8.8	12.2	8.7	12.8	8.5
	16	9.2	7.8	10.2	8.3	10.9	8.8	11.2	8.8	11.5	8.8	12.2	8.7	12.8	8.5
	18	9.2	7.8	10.2	8.3	10.9	8.8	11.2	8.8	11.5	8.8	12.2	8.7	12.8	8.5
	20	9.2	7.8	10.2	8.3	10.9	8.8	11.2	8.8	11.5	8.8	12.2	8.7	12.8	8.5
	21	9.2	7.8	10.2	8.3	10.9	8.8	11.2	8.8	11.5	8.8	12.2	8.7	12.8	8.5
	23	9.2	7.8	10.2	8.3	10.9	8.8	11.2	8.8	11.5	8.8	12.2	8.7	12.8	8.5
	25	9.2	7.8	10.2	8.3	10.9	8.8	11.2	8.8	11.5	8.8	12.2	8.7	12.8	8.5
	27	9.2	7.8	10.2	8.3	10.9	8.8	11.2	8.8	11.5	8.8	12.2	8.7	12.8	8.5
	29	9.2	7.8	10.2	8.3	10.9	8.8	11.2	8.8	11.5	8.8	12.2	8.7	12.8	8.5
	31	9.2	7.8	10.2	8.3	10.9	8.8	11.2	8.8	11.5	8.8	12.2	8.7	12.8	8.5
	33	9.2	7.8	10.2	8.3	10.9	8.8	11.2	8.8	11.5	8.8	12.2	8.7	12.8	8.5
	35	9.2	7.8	10.2	8.3	10.9	8.8	11.2	8.8	11.5	8.8	12.2	8.7	12.8	8.5
	37	8.9	7.6	9.9	8.1	10.5	8.6	10.9	8.5	11.2	8.5	11.8	8.5	12.4	8.3
	39	8.5	7.2	9.4	7.7	10.1	8.2	10.4	8.2	10.7	8.2	11.3	8.1	11.8	7.9
40	8.3	7.0	9.2	7.5	9.8	7.9	10.1	7.9	10.4	7.9	11.0	7.8	11.5	7.7	
42	7.7	6.5	8.5	7.0	9.1	7.4	9.4	7.4	9.7	7.4	10.2	7.3	10.7	7.1	
44	7.0	5.9	7.7	6.3	8.3	6.7	8.5	6.7	8.8	6.7	9.3	6.6	9.7	6.5	
46	6.2	5.2	6.8	5.6	7.3	5.9	7.5	5.9	7.8	5.9	8.2	5.9	8.6	5.7	



Concealed Duct Standard Type (MMD-AP__6BHP-E)

TC : Total capacity [kW] SHC : Sensible capacity [kW]

unit size	outdoor air temp. °CDB	indoor air temp.													
		14°CWB		16°CWB		18°CWB		19°CWB		20°CWB		22°CWB		24°CWB	
		20°CDB		23°CDB		26°CDB		27°CDB		28°CDB		30°CDB		32°CDB	
		TC	SHC	TC	SHC	TC	SHC	TC	SHC	TC	SHC	TC	SHC	TC	SHC
048	10	11.5	9.5	12.7	10.1	13.6	10.7	14.0	10.7	14.4	10.7	15.3	10.6	16.0	10.4
	12	11.5	9.5	12.7	10.1	13.6	10.7	14.0	10.7	14.4	10.7	15.3	10.6	16.0	10.4
	14	11.5	9.5	12.7	10.1	13.6	10.7	14.0	10.7	14.4	10.7	15.3	10.6	16.0	10.4
	16	11.5	9.5	12.7	10.1	13.6	10.7	14.0	10.7	14.4	10.7	15.3	10.6	16.0	10.4
	18	11.5	9.5	12.7	10.1	13.6	10.7	14.0	10.7	14.4	10.7	15.3	10.6	16.0	10.4
	20	11.5	9.5	12.7	10.1	13.6	10.7	14.0	10.7	14.4	10.7	15.3	10.6	16.0	10.4
	21	11.5	9.5	12.7	10.1	13.6	10.7	14.0	10.7	14.4	10.7	15.3	10.6	16.0	10.4
	23	11.5	9.5	12.7	10.1	13.6	10.7	14.0	10.7	14.4	10.7	15.3	10.6	16.0	10.4
	25	11.5	9.5	12.7	10.1	13.6	10.7	14.0	10.7	14.4	10.7	15.3	10.6	16.0	10.4
	27	11.5	9.5	12.7	10.1	13.6	10.7	14.0	10.7	14.4	10.7	15.3	10.6	16.0	10.4
	29	11.5	9.5	12.7	10.1	13.6	10.7	14.0	10.7	14.4	10.7	15.3	10.6	16.0	10.4
	31	11.5	9.5	12.7	10.1	13.6	10.7	14.0	10.7	14.4	10.7	15.3	10.6	16.0	10.4
	33	11.5	9.5	12.7	10.1	13.6	10.7	14.0	10.7	14.4	10.7	15.3	10.6	16.0	10.4
	35	11.5	9.5	12.7	10.1	13.6	10.7	14.0	10.7	14.4	10.7	15.3	10.6	16.0	10.4
	37	11.1	9.2	12.3	9.8	13.2	10.4	13.6	10.4	14.0	10.4	14.8	10.3	15.5	10.0
	39	10.7	8.8	11.8	9.4	12.6	9.9	13.0	9.9	13.4	9.9	14.1	9.8	14.8	9.6
	40	10.3	8.5	11.4	9.1	12.2	9.7	12.6	9.6	13.0	9.6	13.7	9.5	14.4	9.3
42	9.6	7.9	10.6	8.5	11.4	9.0	11.7	9.0	12.1	9.0	12.8	8.9	13.4	8.7	
44	8.8	7.2	9.7	7.7	10.3	8.2	10.7	8.1	11.0	8.1	11.6	8.1	12.2	7.9	
46	7.7	6.4	8.5	6.8	9.1	7.2	9.4	7.2	9.7	7.2	10.3	7.1	10.7	7.0	
056	10	13.1	10.2	14.5	10.9	15.5	11.5	16.0	11.5	16.5	11.5	17.4	11.4	18.2	11.1
	12	13.1	10.2	14.5	10.9	15.5	11.5	16.0	11.5	16.5	11.5	17.4	11.4	18.2	11.1
	14	13.1	10.2	14.5	10.9	15.5	11.5	16.0	11.5	16.5	11.5	17.4	11.4	18.2	11.1
	16	13.1	10.2	14.5	10.9	15.5	11.5	16.0	11.5	16.5	11.5	17.4	11.4	18.2	11.1
	18	13.1	10.2	14.5	10.9	15.5	11.5	16.0	11.5	16.5	11.5	17.4	11.4	18.2	11.1
	20	13.1	10.2	14.5	10.9	15.5	11.5	16.0	11.5	16.5	11.5	17.4	11.4	18.2	11.1
	21	13.1	10.2	14.5	10.9	15.5	11.5	16.0	11.5	16.5	11.5	17.4	11.4	18.2	11.1
	23	13.1	10.2	14.5	10.9	15.5	11.5	16.0	11.5	16.5	11.5	17.4	11.4	18.2	11.1
	25	13.1	10.2	14.5	10.9	15.5	11.5	16.0	11.5	16.5	11.5	17.4	11.4	18.2	11.1
	27	13.1	10.2	14.5	10.9	15.5	11.5	16.0	11.5	16.5	11.5	17.4	11.4	18.2	11.1
	29	13.1	10.2	14.5	10.9	15.5	11.5	16.0	11.5	16.5	11.5	17.4	11.4	18.2	11.1
	31	13.1	10.2	14.5	10.9	15.5	11.5	16.0	11.5	16.5	11.5	17.4	11.4	18.2	11.1
	33	13.1	10.2	14.5	10.9	15.5	11.5	16.0	11.5	16.5	11.5	17.4	11.4	18.2	11.1
	35	13.1	10.2	14.5	10.9	15.5	11.5	16.0	11.5	16.5	11.5	17.4	11.4	18.2	11.1
	37	12.7	9.9	14.1	10.5	15.1	11.2	15.5	11.2	16.0	11.2	16.9	11.1	17.7	10.8
	39	12.2	9.4	13.5	10.1	14.4	10.7	14.8	10.7	15.3	10.7	16.2	10.6	16.9	10.3
	40	11.8	9.2	13.1	9.8	14.0	10.4	14.4	10.4	14.8	10.4	15.7	10.3	16.4	10.0
42	11.0	8.5	12.2	9.1	13.0	9.7	13.4	9.6	13.8	9.6	14.6	9.5	15.3	9.3	
44	10.0	7.8	11.1	8.3	11.8	8.8	12.2	8.8	12.5	8.8	13.3	8.7	13.9	8.5	
46	8.8	6.9	9.8	7.3	10.4	7.8	10.8	7.7	11.1	7.7	11.7	7.7	12.3	7.5	



Concealed Duct High Static Pressure Type (MMD-AP__6HP-E)

TC : Total capacity [kW] SHC : Sensible capacity [kW]

unit size	outdoor air temp. °CDB	indoor air temp.													
		14°CWB		16°CWB		18°CWB		19°CWB		20°CWB		22°CWB		24°CWB	
		20°CDB	23°CDB	26°CDB	27°CDB	28°CDB	30°CDB	32°CDB	TC	SHC	TC	SHC	TC	SHC	TC
018	10	4.6	4.0	5.1	4.2	5.4	4.5	5.6	4.5	5.8	4.5	6.1	4.5	6.4	4.4
	12	4.6	4.0	5.1	4.2	5.4	4.5	5.6	4.5	5.8	4.5	6.1	4.5	6.4	4.4
	14	4.6	4.0	5.1	4.2	5.4	4.5	5.6	4.5	5.8	4.5	6.1	4.5	6.4	4.4
	16	4.6	4.0	5.1	4.2	5.4	4.5	5.6	4.5	5.8	4.5	6.1	4.5	6.4	4.4
	18	4.6	4.0	5.1	4.2	5.4	4.5	5.6	4.5	5.8	4.5	6.1	4.5	6.4	4.4
	20	4.6	4.0	5.1	4.2	5.4	4.5	5.6	4.5	5.8	4.5	6.1	4.5	6.4	4.4
	21	4.6	4.0	5.1	4.2	5.4	4.5	5.6	4.5	5.8	4.5	6.1	4.5	6.4	4.4
	23	4.6	4.0	5.1	4.2	5.4	4.5	5.6	4.5	5.8	4.5	6.1	4.5	6.4	4.4
	25	4.6	4.0	5.1	4.2	5.4	4.5	5.6	4.5	5.8	4.5	6.1	4.5	6.4	4.4
	27	4.6	4.0	5.1	4.2	5.4	4.5	5.6	4.5	5.8	4.5	6.1	4.5	6.4	4.4
	29	4.6	4.0	5.1	4.2	5.4	4.5	5.6	4.5	5.8	4.5	6.1	4.5	6.4	4.4
	31	4.6	4.0	5.1	4.2	5.4	4.5	5.6	4.5	5.8	4.5	6.1	4.5	6.4	4.4
	33	4.6	4.0	5.1	4.2	5.4	4.5	5.6	4.5	5.8	4.5	6.1	4.5	6.4	4.4
	35	4.6	4.0	5.1	4.2	5.4	4.5	5.6	4.5	5.8	4.5	6.1	4.5	6.4	4.4
	37	4.5	3.9	4.9	4.1	5.3	4.4	5.4	4.4	5.6	4.4	5.9	4.3	6.2	4.2
	39	4.3	3.7	4.7	3.9	5.0	4.2	5.2	4.2	5.3	4.2	5.7	4.1	5.9	4.0
40	4.1	3.6	4.6	3.8	4.9	4.1	5.0	4.1	5.2	4.1	5.5	4.0	5.7	3.9	
42	3.8	3.3	4.3	3.6	4.5	3.8	4.7	3.8	4.8	3.8	5.1	3.7	5.3	3.6	
44	3.5	3.0	3.9	3.2	4.1	3.4	4.3	3.4	4.4	3.4	4.6	3.4	4.9	3.3	
46	3.1	2.7	3.4	2.9	3.7	3.0	3.8	3.0	3.9	3.0	4.1	3.0	4.3	2.9	
024	10	5.8	5.0	6.4	5.3	6.9	5.6	7.1	5.6	7.3	5.6	7.7	5.5	8.1	5.4
	12	5.8	5.0	6.4	5.3	6.9	5.6	7.1	5.6	7.3	5.6	7.7	5.5	8.1	5.4
	14	5.8	5.0	6.4	5.3	6.9	5.6	7.1	5.6	7.3	5.6	7.7	5.5	8.1	5.4
	16	5.8	5.0	6.4	5.3	6.9	5.6	7.1	5.6	7.3	5.6	7.7	5.5	8.1	5.4
	18	5.8	5.0	6.4	5.3	6.9	5.6	7.1	5.6	7.3	5.6	7.7	5.5	8.1	5.4
	20	5.8	5.0	6.4	5.3	6.9	5.6	7.1	5.6	7.3	5.6	7.7	5.5	8.1	5.4
	21	5.8	5.0	6.4	5.3	6.9	5.6	7.1	5.6	7.3	5.6	7.7	5.5	8.1	5.4
	23	5.8	5.0	6.4	5.3	6.9	5.6	7.1	5.6	7.3	5.6	7.7	5.5	8.1	5.4
	25	5.8	5.0	6.4	5.3	6.9	5.6	7.1	5.6	7.3	5.6	7.7	5.5	8.1	5.4
	27	5.8	5.0	6.4	5.3	6.9	5.6	7.1	5.6	7.3	5.6	7.7	5.5	8.1	5.4
	29	5.8	5.0	6.4	5.3	6.9	5.6	7.1	5.6	7.3	5.6	7.7	5.5	8.1	5.4
	31	5.8	5.0	6.4	5.3	6.9	5.6	7.1	5.6	7.3	5.6	7.7	5.5	8.1	5.4
	33	5.8	5.0	6.4	5.3	6.9	5.6	7.1	5.6	7.3	5.6	7.7	5.5	8.1	5.4
	35	5.8	5.0	6.4	5.3	6.9	5.6	7.1	5.6	7.3	5.6	7.7	5.5	8.1	5.4
	37	5.7	4.8	6.3	5.1	6.7	5.4	6.9	5.4	7.1	5.4	7.5	5.4	7.9	5.3
	39	5.4	4.6	6.0	4.9	6.4	5.2	6.6	5.2	6.8	5.2	7.2	5.1	7.5	5.0
40	5.2	4.5	5.8	4.8	6.2	5.1	6.4	5.0	6.6	5.0	7.0	5.0	7.3	4.9	
42	4.9	4.2	5.4	4.4	5.8	4.7	5.9	4.7	6.1	4.7	6.5	4.6	6.8	4.5	
44	4.4	3.8	4.9	4.0	5.2	4.3	5.4	4.3	5.6	4.3	5.9	4.2	6.2	4.1	
46	3.9	3.3	4.3	3.6	4.6	3.8	4.8	3.8	4.9	3.8	5.2	3.7	5.4	3.6	
027	10	6.6	5.4	7.3	5.8	7.8	6.1	8.0	6.1	8.2	6.1	8.7	6.0	9.1	5.9
	12	6.6	5.4	7.3	5.8	7.8	6.1	8.0	6.1	8.2	6.1	8.7	6.0	9.1	5.9
	14	6.6	5.4	7.3	5.8	7.8	6.1	8.0	6.1	8.2	6.1	8.7	6.0	9.1	5.9
	16	6.6	5.4	7.3	5.8	7.8	6.1	8.0	6.1	8.2	6.1	8.7	6.0	9.1	5.9
	18	6.6	5.4	7.3	5.8	7.8	6.1	8.0	6.1	8.2	6.1	8.7	6.0	9.1	5.9
	20	6.6	5.4	7.3	5.8	7.8	6.1	8.0	6.1	8.2	6.1	8.7	6.0	9.1	5.9
	21	6.6	5.4	7.3	5.8	7.8	6.1	8.0	6.1	8.2	6.1	8.7	6.0	9.1	5.9
	23	6.6	5.4	7.3	5.8	7.8	6.1	8.0	6.1	8.2	6.1	8.7	6.0	9.1	5.9
	25	6.6	5.4	7.3	5.8	7.8	6.1	8.0	6.1	8.2	6.1	8.7	6.0	9.1	5.9
	27	6.6	5.4	7.3	5.8	7.8	6.1	8.0	6.1	8.2	6.1	8.7	6.0	9.1	5.9
	29	6.6	5.4	7.3	5.8	7.8	6.1	8.0	6.1	8.2	6.1	8.7	6.0	9.1	5.9
	31	6.6	5.4	7.3	5.8	7.8	6.1	8.0	6.1	8.2	6.1	8.7	6.0	9.1	5.9
	33	6.6	5.4	7.3	5.8	7.8	6.1	8.0	6.1	8.2	6.1	8.7	6.0	9.1	5.9
	35	6.6	5.4	7.3	5.8	7.8	6.1	8.0	6.1	8.2	6.1	8.7	6.0	9.1	5.9
	37	6.4	5.2	7.0	5.6	7.5	5.9	7.8	5.9	8.0	5.9	8.5	5.9	8.8	5.7
	39	6.1	5.0	6.7	5.3	7.2	5.7	7.4	5.7	7.6	5.7	8.1	5.6	8.5	5.5
40	5.9	4.9	6.5	5.2	7.0	5.5	7.2	5.5	7.4	5.5	7.8	5.4	8.2	5.3	
42	5.5	4.5	6.1	4.8	6.5	5.1	6.7	5.1	6.9	5.1	7.3	5.1	7.6	4.9	
44	5.0	4.1	5.5	4.4	5.9	4.7	6.1	4.6	6.3	4.6	6.6	4.6	6.9	4.5	
46	4.4	3.6	4.9	3.9	5.2	4.1	5.4	4.1	5.5	4.1	5.9	4.1	6.1	4.0	



Concealed Duct High Static Pressure Type (MMD-AP___6HP-E)

TC : Total capacity [kW] SHC : Sensible capacity [kW]

unit size	outdoor air temp. °CDB	indoor air temp.													
		14°CWB		16°CWB		18°CWB		19°CWB		20°CWB		22°CWB		24°CWB	
		20°CDB	23°CDB	26°CDB	27°CDB	28°CDB	30°CDB	32°CDB	TC	SHC	TC	SHC	TC	SHC	TC
036	10	9.2	7.5	10.2	8.0	10.9	8.5	11.2	8.5	11.5	8.5	12.2	8.4	12.8	8.2
	12	9.2	7.5	10.2	8.0	10.9	8.5	11.2	8.5	11.5	8.5	12.2	8.4	12.8	8.2
	14	9.2	7.5	10.2	8.0	10.9	8.5	11.2	8.5	11.5	8.5	12.2	8.4	12.8	8.2
	16	9.2	7.5	10.2	8.0	10.9	8.5	11.2	8.5	11.5	8.5	12.2	8.4	12.8	8.2
	18	9.2	7.5	10.2	8.0	10.9	8.5	11.2	8.5	11.5	8.5	12.2	8.4	12.8	8.2
	20	9.2	7.5	10.2	8.0	10.9	8.5	11.2	8.5	11.5	8.5	12.2	8.4	12.8	8.2
	21	9.2	7.5	10.2	8.0	10.9	8.5	11.2	8.5	11.5	8.5	12.2	8.4	12.8	8.2
	23	9.2	7.5	10.2	8.0	10.9	8.5	11.2	8.5	11.5	8.5	12.2	8.4	12.8	8.2
	25	9.2	7.5	10.2	8.0	10.9	8.5	11.2	8.5	11.5	8.5	12.2	8.4	12.8	8.2
	27	9.2	7.5	10.2	8.0	10.9	8.5	11.2	8.5	11.5	8.5	12.2	8.4	12.8	8.2
	29	9.2	7.5	10.2	8.0	10.9	8.5	11.2	8.5	11.5	8.5	12.2	8.4	12.8	8.2
	31	9.2	7.5	10.2	8.0	10.9	8.5	11.2	8.5	11.5	8.5	12.2	8.4	12.8	8.2
	33	9.2	7.5	10.2	8.0	10.9	8.5	11.2	8.5	11.5	8.5	12.2	8.4	12.8	8.2
	35	9.2	7.5	10.2	8.0	10.9	8.5	11.2	8.5	11.5	8.5	12.2	8.4	12.8	8.2
	37	8.9	7.3	9.9	7.8	10.5	8.3	10.9	8.2	11.2	8.2	11.8	8.2	12.4	8.0
	39	8.5	7.0	9.4	7.4	10.1	7.9	10.4	7.9	10.7	7.9	11.3	7.8	11.8	7.6
	40	8.3	6.8	9.2	7.2	9.8	7.7	10.1	7.7	10.4	7.7	11.0	7.6	11.5	7.4
42	7.7	6.3	8.5	6.7	9.1	7.1	9.4	7.1	9.7	7.1	10.2	7.1	10.7	6.9	
44	7.0	5.7	7.7	6.1	8.3	6.5	8.5	6.5	8.8	6.5	9.3	6.4	9.7	6.3	
46	6.2	5.1	6.8	5.4	7.3	5.7	7.5	5.7	7.8	5.7	8.2	5.7	8.6	5.5	
048	10	11.5	9.5	12.7	10.1	13.6	10.7	14.0	10.7	14.4	10.7	15.3	10.6	16.0	10.4
	12	11.5	9.5	12.7	10.1	13.6	10.7	14.0	10.7	14.4	10.7	15.3	10.6	16.0	10.4
	14	11.5	9.5	12.7	10.1	13.6	10.7	14.0	10.7	14.4	10.7	15.3	10.6	16.0	10.4
	16	11.5	9.5	12.7	10.1	13.6	10.7	14.0	10.7	14.4	10.7	15.3	10.6	16.0	10.4
	18	11.5	9.5	12.7	10.1	13.6	10.7	14.0	10.7	14.4	10.7	15.3	10.6	16.0	10.4
	20	11.5	9.5	12.7	10.1	13.6	10.7	14.0	10.7	14.4	10.7	15.3	10.6	16.0	10.4
	21	11.5	9.5	12.7	10.1	13.6	10.7	14.0	10.7	14.4	10.7	15.3	10.6	16.0	10.4
	23	11.5	9.5	12.7	10.1	13.6	10.7	14.0	10.7	14.4	10.7	15.3	10.6	16.0	10.4
	25	11.5	9.5	12.7	10.1	13.6	10.7	14.0	10.7	14.4	10.7	15.3	10.6	16.0	10.4
	27	11.5	9.5	12.7	10.1	13.6	10.7	14.0	10.7	14.4	10.7	15.3	10.6	16.0	10.4
	29	11.5	9.5	12.7	10.1	13.6	10.7	14.0	10.7	14.4	10.7	15.3	10.6	16.0	10.4
	31	11.5	9.5	12.7	10.1	13.6	10.7	14.0	10.7	14.4	10.7	15.3	10.6	16.0	10.4
	33	11.5	9.5	12.7	10.1	13.6	10.7	14.0	10.7	14.4	10.7	15.3	10.6	16.0	10.4
	35	11.5	9.5	12.7	10.1	13.6	10.7	14.0	10.7	14.4	10.7	15.3	10.6	16.0	10.4
	37	11.1	9.2	12.3	9.8	13.2	10.4	13.6	10.4	14.0	10.4	14.8	10.3	15.5	10.0
	39	10.7	8.8	11.8	9.4	12.6	9.9	13.0	9.9	13.4	9.9	14.1	9.8	14.8	9.6
	40	10.3	8.5	11.4	9.1	12.2	9.7	12.6	9.6	13.0	9.6	13.7	9.5	14.4	9.3
42	9.6	7.9	10.6	8.5	11.4	9.0	11.7	9.0	12.1	9.0	12.8	8.9	13.4	8.7	
44	8.8	7.2	9.7	7.7	10.3	8.2	10.7	8.1	11.0	8.1	11.6	8.1	12.2	7.9	
46	7.7	6.4	8.5	6.8	9.1	7.2	9.4	7.2	9.7	7.2	10.3	7.1	10.7	7.0	
056	10	13.1	10.2	14.5	10.9	15.5	11.5	16.0	11.5	16.5	11.5	17.4	11.4	18.2	11.1
	12	13.1	10.2	14.5	10.9	15.5	11.5	16.0	11.5	16.5	11.5	17.4	11.4	18.2	11.1
	14	13.1	10.2	14.5	10.9	15.5	11.5	16.0	11.5	16.5	11.5	17.4	11.4	18.2	11.1
	16	13.1	10.2	14.5	10.9	15.5	11.5	16.0	11.5	16.5	11.5	17.4	11.4	18.2	11.1
	18	13.1	10.2	14.5	10.9	15.5	11.5	16.0	11.5	16.5	11.5	17.4	11.4	18.2	11.1
	20	13.1	10.2	14.5	10.9	15.5	11.5	16.0	11.5	16.5	11.5	17.4	11.4	18.2	11.1
	21	13.1	10.2	14.5	10.9	15.5	11.5	16.0	11.5	16.5	11.5	17.4	11.4	18.2	11.1
	23	13.1	10.2	14.5	10.9	15.5	11.5	16.0	11.5	16.5	11.5	17.4	11.4	18.2	11.1
	25	13.1	10.2	14.5	10.9	15.5	11.5	16.0	11.5	16.5	11.5	17.4	11.4	18.2	11.1
	27	13.1	10.2	14.5	10.9	15.5	11.5	16.0	11.5	16.5	11.5	17.4	11.4	18.2	11.1
	29	13.1	10.2	14.5	10.9	15.5	11.5	16.0	11.5	16.5	11.5	17.4	11.4	18.2	11.1
	31	13.1	10.2	14.5	10.9	15.5	11.5	16.0	11.5	16.5	11.5	17.4	11.4	18.2	11.1
	33	13.1	10.2	14.5	10.9	15.5	11.5	16.0	11.5	16.5	11.5	17.4	11.4	18.2	11.1
	35	13.1	10.2	14.5	10.9	15.5	11.5	16.0	11.5	16.5	11.5	17.4	11.4	18.2	11.1
	37	12.7	9.9	14.1	10.5	15.1	11.2	15.5	11.2	16.0	11.2	16.9	11.1	17.7	10.8
	39	12.2	9.4	13.5	10.1	14.4	10.7	14.8	10.7	15.3	10.7	16.2	10.6	16.9	10.3
	40	11.8	9.2	13.1	9.8	14.0	10.4	14.4	10.4	14.8	10.4	15.7	10.3	16.4	10.0
42	11.0	8.5	12.2	9.1	13.0	9.7	13.4	9.6	13.8	9.6	14.6	9.5	15.3	9.3	
44	10.0	7.8	11.1	8.3	11.8	8.8	12.2	8.8	12.5	8.8	13.3	8.7	13.9	8.5	
46	8.8	6.9	9.8	7.3	10.4	7.8	10.8	7.7	11.1	7.7	11.7	7.7	12.3	7.5	



Concealed Duct High Static Pressure Type (MMD-AP___4H-E)

TC : Total capacity [kW] SHC : Sensible capacity [kW]

unit size	outdoor air temp. °CDB	indoor air temp.													
		14°CWB		16°CWB		18°CWB		19°CWB		20°CWB		22°CWB		24°CWB	
		20°CDB		23°CDB		26°CDB		27°CDB		28°CDB		30°CDB		32°CDB	
		TC	SHC	TC	SHC	TC	SHC	TC	SHC	TC	SHC	TC	SHC	TC	SHC
072	10	13.1	10.2	14.5	10.9	15.5	11.5	16.0	11.5	16.5	11.5	17.4	11.4	18.2	11.1
	12	13.1	10.2	14.5	10.9	15.5	11.5	16.0	11.5	16.5	11.5	17.4	11.4	18.2	11.1
	14	13.1	10.2	14.5	10.9	15.5	11.5	16.0	11.5	16.5	11.5	17.4	11.4	18.2	11.1
	16	13.1	10.2	14.5	10.9	15.5	11.5	16.0	11.5	16.5	11.5	17.4	11.4	18.2	11.1
	18	13.1	10.2	14.5	10.9	15.5	11.5	16.0	11.5	16.5	11.5	17.4	11.4	18.2	11.1
	20	13.1	10.2	14.5	10.9	15.5	11.5	16.0	11.5	16.5	11.5	17.4	11.4	18.2	11.1
	21	13.1	10.2	14.5	10.9	15.5	11.5	16.0	11.5	16.5	11.5	17.4	11.4	18.2	11.1
	23	13.1	10.2	14.5	10.9	15.5	11.5	16.0	11.5	16.5	11.5	17.4	11.4	18.2	11.1
	25	13.1	10.2	14.5	10.9	15.5	11.5	16.0	11.5	16.5	11.5	17.4	11.4	18.2	11.1
	27	13.1	10.2	14.5	10.9	15.5	11.5	16.0	11.5	16.5	11.5	17.4	11.4	18.2	11.1
	29	13.1	10.2	14.5	10.9	15.5	11.5	16.0	11.5	16.5	11.5	17.4	11.4	18.2	11.1
	31	13.1	10.2	14.5	10.9	15.5	11.5	16.0	11.5	16.5	11.5	17.4	11.4	18.2	11.1
	33	13.1	10.2	14.5	10.9	15.5	11.5	16.0	11.5	16.5	11.5	17.4	11.4	18.2	11.1
	35	18.4	14.6	20.3	15.6	21.7	16.5	22.4	16.5	23.1	16.5	24.4	16.3	25.5	16.0
	37	12.7	9.9	14.1	10.5	15.1	11.2	15.5	11.2	16.0	11.2	16.9	11.1	17.7	10.8
	39	12.2	9.4	13.5	10.1	14.4	10.7	14.8	10.7	15.3	10.7	16.2	10.6	16.9	10.3
	40	11.8	9.2	13.1	9.8	14.0	10.4	14.4	10.4	14.8	10.4	15.7	10.3	16.4	10.0
	42	11.0	8.5	12.2	9.1	13.0	9.7	13.4	9.6	13.8	9.6	14.6	9.5	15.3	9.3
44	10.0	7.8	11.1	8.3	11.8	8.8	12.2	8.8	12.5	8.8	13.3	8.7	13.9	8.5	
46	8.8	6.9	9.8	7.3	10.4	7.8	10.8	7.7	11.1	7.7	11.7	7.7	12.3	7.5	
096	10	18.4	14.6	20.3	15.6	21.7	16.5	22.4	16.5	23.1	16.5	24.4	16.3	25.5	16.0
	12	18.4	14.6	20.3	15.6	21.7	16.5	22.4	16.5	23.1	16.5	24.4	16.3	25.5	16.0
	14	18.4	14.6	20.3	15.6	21.7	16.5	22.4	16.5	23.1	16.5	24.4	16.3	25.5	16.0
	16	18.4	14.6	20.3	15.6	21.7	16.5	22.4	16.5	23.1	16.5	24.4	16.3	25.5	16.0
	18	18.4	14.6	20.3	15.6	21.7	16.5	22.4	16.5	23.1	16.5	24.4	16.3	25.5	16.0
	20	18.4	14.6	20.3	15.6	21.7	16.5	22.4	16.5	23.1	16.5	24.4	16.3	25.5	16.0
	21	18.4	14.6	20.3	15.6	21.7	16.5	22.4	16.5	23.1	16.5	24.4	16.3	25.5	16.0
	23	18.4	14.6	20.3	15.6	21.7	16.5	22.4	16.5	23.1	16.5	24.4	16.3	25.5	16.0
	25	18.4	14.6	20.3	15.6	21.7	16.5	22.4	16.5	23.1	16.5	24.4	16.3	25.5	16.0
	27	18.4	14.6	20.3	15.6	21.7	16.5	22.4	16.5	23.1	16.5	24.4	16.3	25.5	16.0
	29	18.4	14.6	20.3	15.6	21.7	16.5	22.4	16.5	23.1	16.5	24.4	16.3	25.5	16.0
	31	18.4	14.6	20.3	15.6	21.7	16.5	22.4	16.5	23.1	16.5	24.4	16.3	25.5	16.0
	33	18.4	14.6	20.3	15.6	21.7	16.5	22.4	16.5	23.1	16.5	24.4	16.3	25.5	16.0
	35	23.0	17.9	25.4	19.1	27.2	20.3	28.0	20.2	28.8	20.2	30.5	20.0	31.9	19.5
	37	17.8	14.2	19.7	15.1	21.1	16.1	21.7	16.0	22.4	16.0	23.7	15.9	24.8	15.5
	39	17.0	13.6	18.8	14.4	20.1	15.3	20.8	15.3	21.4	15.3	22.6	15.1	23.7	14.8
	40	16.6	13.2	18.3	14.0	19.6	14.9	20.2	14.9	20.8	14.9	22.0	14.7	23.0	14.4
	42	15.4	12.2	17.0	13.0	18.2	13.9	18.8	13.8	19.3	13.8	20.4	13.7	21.4	13.4
44	14.0	11.1	15.5	11.9	16.5	12.6	17.1	12.6	17.6	12.6	18.6	12.4	19.4	12.2	
46	12.4	9.8	13.7	10.5	14.6	11.1	15.1	11.1	15.5	11.1	16.4	11.0	17.2	10.7	



Slim Duct Type (MMD-AP ___ 4SPH-E)

TC : Total capacity [kW] SHC : Sensible capacity [kW]

unit size	outdoor air temp. °CDB	indoor air temp.													
		14°CWB		16°CWB		18°CWB		19°CWB		20°CWB		22°CWB		24°CWB	
		TC	SHC	TC	SHC	TC	SHC	TC	SHC	TC	SHC	TC	SHC	TC	SHC
007	10	1.8	1.6	2.0	1.7	2.1	1.8	2.2	1.8	2.3	1.8	2.4	1.8	2.5	1.7
	12	1.8	1.6	2.0	1.7	2.1	1.8	2.2	1.8	2.3	1.8	2.4	1.8	2.5	1.7
	14	1.8	1.6	2.0	1.7	2.1	1.8	2.2	1.8	2.3	1.8	2.4	1.8	2.5	1.7
	16	1.8	1.6	2.0	1.7	2.1	1.8	2.2	1.8	2.3	1.8	2.4	1.8	2.5	1.7
	18	1.8	1.6	2.0	1.7	2.1	1.8	2.2	1.8	2.3	1.8	2.4	1.8	2.5	1.7
	20	1.8	1.6	2.0	1.7	2.1	1.8	2.2	1.8	2.3	1.8	2.4	1.8	2.5	1.7
	21	1.8	1.6	2.0	1.7	2.1	1.8	2.2	1.8	2.3	1.8	2.4	1.8	2.5	1.7
	23	1.8	1.6	2.0	1.7	2.1	1.8	2.2	1.8	2.3	1.8	2.4	1.8	2.5	1.7
	25	1.8	1.6	2.0	1.7	2.1	1.8	2.2	1.8	2.3	1.8	2.4	1.8	2.5	1.7
	27	1.8	1.6	2.0	1.7	2.1	1.8	2.2	1.8	2.3	1.8	2.4	1.8	2.5	1.7
	29	1.8	1.6	2.0	1.7	2.1	1.8	2.2	1.8	2.3	1.8	2.4	1.8	2.5	1.7
	31	1.8	1.6	2.0	1.7	2.1	1.8	2.2	1.8	2.3	1.8	2.4	1.8	2.5	1.7
	33	1.8	1.6	2.0	1.7	2.1	1.8	2.2	1.8	2.3	1.8	2.4	1.8	2.5	1.7
	35	1.8	1.6	2.0	1.7	2.1	1.8	2.2	1.8	2.3	1.8	2.4	1.8	2.5	1.7
	37	1.8	1.5	1.9	1.6	2.1	1.8	2.1	1.7	2.2	1.7	2.3	1.7	2.4	1.7
	39	1.7	1.5	1.9	1.6	2.0	1.7	2.0	1.7	2.1	1.7	2.2	1.7	2.3	1.6
	40	1.6	1.4	1.8	1.5	1.9	1.6	2.0	1.6	2.0	1.6	2.2	1.6	2.3	1.6
42	1.5	1.3	1.7	1.4	1.8	1.5	1.8	1.5	1.9	1.5	2.0	1.5	2.1	1.5	
44	1.4	1.2	1.5	1.3	1.6	1.4	1.7	1.4	1.7	1.4	1.8	1.4	1.9	1.3	
46	1.2	1.1	1.3	1.1	1.4	1.2	1.5	1.2	1.5	1.2	1.6	1.2	1.7	1.2	
009	10	2.3	2.0	2.5	2.1	2.7	2.2	2.8	2.2	2.9	2.2	3.1	2.2	3.2	2.1
	12	2.3	2.0	2.5	2.1	2.7	2.2	2.8	2.2	2.9	2.2	3.1	2.2	3.2	2.1
	14	2.3	2.0	2.5	2.1	2.7	2.2	2.8	2.2	2.9	2.2	3.1	2.2	3.2	2.1
	16	2.3	2.0	2.5	2.1	2.7	2.2	2.8	2.2	2.9	2.2	3.1	2.2	3.2	2.1
	18	2.3	2.0	2.5	2.1	2.7	2.2	2.8	2.2	2.9	2.2	3.1	2.2	3.2	2.1
	20	2.3	2.0	2.5	2.1	2.7	2.2	2.8	2.2	2.9	2.2	3.1	2.2	3.2	2.1
	21	2.3	2.0	2.5	2.1	2.7	2.2	2.8	2.2	2.9	2.2	3.1	2.2	3.2	2.1
	23	2.3	2.0	2.5	2.1	2.7	2.2	2.8	2.2	2.9	2.2	3.1	2.2	3.2	2.1
	25	2.3	2.0	2.5	2.1	2.7	2.2	2.8	2.2	2.9	2.2	3.1	2.2	3.2	2.1
	27	2.3	2.0	2.5	2.1	2.7	2.2	2.8	2.2	2.9	2.2	3.1	2.2	3.2	2.1
	29	2.3	2.0	2.5	2.1	2.7	2.2	2.8	2.2	2.9	2.2	3.1	2.2	3.2	2.1
	31	2.3	2.0	2.5	2.1	2.7	2.2	2.8	2.2	2.9	2.2	3.1	2.2	3.2	2.1
	33	2.3	2.0	2.5	2.1	2.7	2.2	2.8	2.2	2.9	2.2	3.1	2.2	3.2	2.1
	35	2.3	2.0	2.5	2.1	2.7	2.2	2.8	2.2	2.9	2.2	3.1	2.2	3.2	2.1
	37	2.2	1.9	2.5	2.0	2.6	2.1	2.7	2.1	2.8	2.1	3.0	2.1	3.1	2.1
	39	2.1	1.8	2.4	1.9	2.5	2.0	2.6	2.0	2.7	2.0	2.8	2.0	3.0	2.0
	40	2.1	1.8	2.3	1.9	2.4	2.0	2.5	2.0	2.6	2.0	2.7	2.0	2.9	1.9
42	1.9	1.6	2.1	1.7	2.3	1.8	2.3	1.8	2.4	1.8	2.6	1.8	2.7	1.8	
44	1.8	1.5	1.9	1.6	2.1	1.7	2.1	1.7	2.2	1.7	2.3	1.7	2.4	1.6	
46	1.5	1.3	1.7	1.4	1.8	1.5	1.9	1.5	1.9	1.5	2.1	1.5	2.1	1.4	



Slim Duct Type (MMD-AP___4SPH-E)

TC : Total capacity [kW] SHC : Sensible capacity [kW]

unit size	outdoor air temp. °CDB	indoor air temp.													
		14°CWB		16°CWB		18°CWB		19°CWB		20°CWB		22°CWB		24°CWB	
		20°CDB		23°CDB		26°CDB		27°CDB		28°CDB		30°CDB		32°CDB	
		TC	SHC	TC	SHC	TC	SHC	TC	SHC	TC	SHC	TC	SHC	TC	SHC
012	10	3.0	2.4	3.3	2.5	3.5	2.7	3.6	2.7	3.7	2.7	3.9	2.7	4.1	2.6
	12	3.0	2.4	3.3	2.5	3.5	2.7	3.6	2.7	3.7	2.7	3.9	2.7	4.1	2.6
	14	3.0	2.4	3.3	2.5	3.5	2.7	3.6	2.7	3.7	2.7	3.9	2.7	4.1	2.6
	16	3.0	2.4	3.3	2.5	3.5	2.7	3.6	2.7	3.7	2.7	3.9	2.7	4.1	2.6
	18	3.0	2.4	3.3	2.5	3.5	2.7	3.6	2.7	3.7	2.7	3.9	2.7	4.1	2.6
	20	3.0	2.4	3.3	2.5	3.5	2.7	3.6	2.7	3.7	2.7	3.9	2.7	4.1	2.6
	21	3.0	2.4	3.3	2.5	3.5	2.7	3.6	2.7	3.7	2.7	3.9	2.7	4.1	2.6
	23	3.0	2.4	3.3	2.5	3.5	2.7	3.6	2.7	3.7	2.7	3.9	2.7	4.1	2.6
	25	3.0	2.4	3.3	2.5	3.5	2.7	3.6	2.7	3.7	2.7	3.9	2.7	4.1	2.6
	27	3.0	2.4	3.3	2.5	3.5	2.7	3.6	2.7	3.7	2.7	3.9	2.7	4.1	2.6
	29	3.0	2.4	3.3	2.5	3.5	2.7	3.6	2.7	3.7	2.7	3.9	2.7	4.1	2.6
	31	3.0	2.4	3.3	2.5	3.5	2.7	3.6	2.7	3.7	2.7	3.9	2.7	4.1	2.6
	33	3.0	2.4	3.3	2.5	3.5	2.7	3.6	2.7	3.7	2.7	3.9	2.7	4.1	2.6
	35	3.0	2.4	3.3	2.5	3.5	2.7	3.6	2.7	3.7	2.7	3.9	2.7	4.1	2.6
	37	2.9	2.3	3.2	2.5	3.4	2.6	3.5	2.6	3.6	2.6	3.8	2.6	4.0	2.5
	39	2.7	2.2	3.0	2.4	3.2	2.5	3.3	2.5	3.4	2.5	3.6	2.5	3.8	2.4
40	2.7	2.2	2.9	2.3	3.1	2.4	3.2	2.4	3.3	2.4	3.5	2.4	3.7	2.4	
42	2.5	2.0	2.7	2.1	2.9	2.3	3.0	2.3	3.1	2.3	3.3	2.2	3.4	2.2	
44	2.3	1.8	2.5	1.9	2.7	2.1	2.7	2.1	2.8	2.1	3.0	2.0	3.1	2.0	
46	2.0	1.6	2.2	1.7	2.3	1.8	2.4	1.8	2.5	1.8	2.6	1.8	2.8	1.8	
015	10	3.7	3.0	4.1	3.2	4.4	3.4	4.5	3.4	4.6	3.3	4.9	3.3	5.1	3.2
	12	3.7	3.0	4.1	3.2	4.4	3.4	4.5	3.4	4.6	3.3	4.9	3.3	5.1	3.2
	14	3.7	3.0	4.1	3.2	4.4	3.4	4.5	3.4	4.6	3.3	4.9	3.3	5.1	3.2
	16	3.7	3.0	4.1	3.2	4.4	3.4	4.5	3.4	4.6	3.3	4.9	3.3	5.1	3.2
	18	3.7	3.0	4.1	3.2	4.4	3.4	4.5	3.4	4.6	3.3	4.9	3.3	5.1	3.2
	20	3.7	3.0	4.1	3.2	4.4	3.4	4.5	3.4	4.6	3.3	4.9	3.3	5.1	3.2
	21	3.7	3.0	4.1	3.2	4.4	3.4	4.5	3.4	4.6	3.3	4.9	3.3	5.1	3.2
	23	3.7	3.0	4.1	3.2	4.4	3.4	4.5	3.4	4.6	3.3	4.9	3.3	5.1	3.2
	25	3.7	3.0	4.1	3.2	4.4	3.4	4.5	3.4	4.6	3.3	4.9	3.3	5.1	3.2
	27	3.7	3.0	4.1	3.2	4.4	3.4	4.5	3.4	4.6	3.3	4.9	3.3	5.1	3.2
	29	3.7	3.0	4.1	3.2	4.4	3.4	4.5	3.4	4.6	3.3	4.9	3.3	5.1	3.2
	31	3.7	3.0	4.1	3.2	4.4	3.4	4.5	3.4	4.6	3.3	4.9	3.3	5.1	3.2
	33	3.7	3.0	4.1	3.2	4.4	3.4	4.5	3.4	4.6	3.3	4.9	3.3	5.1	3.2
	35	3.7	3.0	4.1	3.2	4.4	3.4	4.5	3.4	4.6	3.3	4.9	3.3	5.1	3.2
	37	3.6	2.9	4.0	3.1	4.2	3.3	4.4	3.2	4.5	3.2	4.8	3.2	5.0	3.1
	39	3.4	2.8	3.8	2.9	4.0	3.1	4.2	3.1	4.3	3.1	4.5	3.1	4.8	3.0
40	3.3	2.7	3.7	2.8	3.9	3.0	4.1	3.0	4.2	3.0	4.4	3.0	4.6	2.9	
42	3.1	2.5	3.4	2.6	3.7	2.8	3.8	2.8	3.9	2.8	4.1	2.8	4.3	2.7	
44	2.8	2.3	3.1	2.4	3.3	2.6	3.4	2.6	3.5	2.6	3.7	2.5	3.9	2.5	
46	2.5	2.0	2.7	2.1	2.9	2.3	3.0	2.3	3.1	2.3	3.3	2.2	3.4	2.2	
018	10	4.6	3.6	5.1	3.9	5.4	4.1	5.6	4.1	5.8	4.1	6.1	4.1	6.4	4.0
	12	4.6	3.6	5.1	3.9	5.4	4.1	5.6	4.1	5.8	4.1	6.1	4.1	6.4	4.0
	14	4.6	3.6	5.1	3.9	5.4	4.1	5.6	4.1	5.8	4.1	6.1	4.1	6.4	4.0
	16	4.6	3.6	5.1	3.9	5.4	4.1	5.6	4.1	5.8	4.1	6.1	4.1	6.4	4.0
	18	4.6	3.6	5.1	3.9	5.4	4.1	5.6	4.1	5.8	4.1	6.1	4.1	6.4	4.0
	20	4.6	3.6	5.1	3.9	5.4	4.1	5.6	4.1	5.8	4.1	6.1	4.1	6.4	4.0
	21	4.6	3.6	5.1	3.9	5.4	4.1	5.6	4.1	5.8	4.1	6.1	4.1	6.4	4.0
	23	4.6	3.6	5.1	3.9	5.4	4.1	5.6	4.1	5.8	4.1	6.1	4.1	6.4	4.0
	25	4.6	3.6	5.1	3.9	5.4	4.1	5.6	4.1	5.8	4.1	6.1	4.1	6.4	4.0
	27	4.6	3.6	5.1	3.9	5.4	4.1	5.6	4.1	5.8	4.1	6.1	4.1	6.4	4.0
	29	4.6	3.6	5.1	3.9	5.4	4.1	5.6	4.1	5.8	4.1	6.1	4.1	6.4	4.0
	31	4.6	3.6	5.1	3.9	5.4	4.1	5.6	4.1	5.8	4.1	6.1	4.1	6.4	4.0
	33	4.6	3.6	5.1	3.9	5.4	4.1	5.6	4.1	5.8	4.1	6.1	4.1	6.4	4.0
	35	4.6	3.6	5.1	3.9	5.4	4.1	5.6	4.1	5.8	4.1	6.1	4.1	6.4	4.0
	37	4.5	3.5	4.9	3.8	5.3	4.0	5.4	4.0	5.6	4.0	5.9	3.9	6.2	3.8
	39	4.3	3.4	4.7	3.6	5.0	3.8	5.2	3.8	5.3	3.8	5.7	3.8	5.9	3.7
40	4.1	3.3	4.6	3.5	4.9	3.7	5.0	3.7	5.2	3.7	5.5	3.7	5.7	3.6	
42	3.8	3.0	4.3	3.2	4.5	3.4	4.7	3.4	4.8	3.4	5.1	3.4	5.3	3.3	
44	3.5	2.8	3.9	2.9	4.1	3.1	4.3	3.1	4.4	3.1	4.6	3.1	4.9	3.0	
46	3.1	2.4	3.4	2.6	3.7	2.8	3.8	2.8	3.9	2.8	4.1	2.7	4.3	2.7	



Slim Duct Type (MMD-AP ___4SPH-E)

TC : Total capacity [kW] SHC : Sensible capacity [kW]

unit size	outdoor air temp. °CDB	indoor air temp.													
		14°CWB		16°CWB		18°CWB		19°CWB		20°CWB		22°CWB		24°CWB	
		20°CDB		23°CDB		26°CDB		27°CDB		28°CDB		30°CDB		32°CDB	
		TC	SHC	TC	SHC	TC	SHC	TC	SHC	TC	SHC	TC	SHC	TC	SHC
024	10	5.8	4.3	6.4	4.5	6.9	4.8	7.1	4.8	7.3	4.8	7.7	4.8	8.1	4.6
	12	5.8	4.3	6.4	4.5	6.9	4.8	7.1	4.8	7.3	4.8	7.7	4.8	8.1	4.6
	14	5.8	4.3	6.4	4.5	6.9	4.8	7.1	4.8	7.3	4.8	7.7	4.8	8.1	4.6
	16	5.8	4.3	6.4	4.5	6.9	4.8	7.1	4.8	7.3	4.8	7.7	4.8	8.1	4.6
	18	5.8	4.3	6.4	4.5	6.9	4.8	7.1	4.8	7.3	4.8	7.7	4.8	8.1	4.6
	20	5.8	4.3	6.4	4.5	6.9	4.8	7.1	4.8	7.3	4.8	7.7	4.8	8.1	4.6
	21	5.8	4.3	6.4	4.5	6.9	4.8	7.1	4.8	7.3	4.8	7.7	4.8	8.1	4.6
	23	5.8	4.3	6.4	4.5	6.9	4.8	7.1	4.8	7.3	4.8	7.7	4.8	8.1	4.6
	25	5.8	4.3	6.4	4.5	6.9	4.8	7.1	4.8	7.3	4.8	7.7	4.8	8.1	4.6
	27	5.8	4.3	6.4	4.5	6.9	4.8	7.1	4.8	7.3	4.8	7.7	4.8	8.1	4.6
	29	5.8	4.3	6.4	4.5	6.9	4.8	7.1	4.8	7.3	4.8	7.7	4.8	8.1	4.6
	31	5.8	4.3	6.4	4.5	6.9	4.8	7.1	4.8	7.3	4.8	7.7	4.8	8.1	4.6
	33	5.8	4.3	6.4	4.5	6.9	4.8	7.1	4.8	7.3	4.8	7.7	4.8	8.1	4.6
	35	5.8	4.3	6.4	4.5	6.9	4.8	7.1	4.8	7.3	4.8	7.7	4.8	8.1	4.6
	37	5.7	4.1	6.3	4.4	6.7	4.7	6.9	4.7	7.1	4.7	7.5	4.6	7.9	4.5
	39	5.4	3.9	6.0	4.2	6.4	4.5	6.6	4.4	6.8	4.4	7.2	4.4	7.5	4.3
	40	5.2	3.8	5.8	4.1	6.2	4.3	6.4	4.3	6.6	4.3	7.0	4.3	7.3	4.2
42	4.9	3.6	5.4	3.8	5.8	4.0	5.9	4.0	6.1	4.0	6.5	4.0	6.8	3.9	
44	4.4	3.2	4.9	3.5	5.2	3.7	5.4	3.7	5.6	3.7	5.9	3.6	6.2	3.5	
46	3.9	2.9	4.3	3.0	4.6	3.2	4.8	3.2	4.9	3.2	5.2	3.2	5.4	3.1	
027	10	6.6	4.8	7.3	5.1	7.8	5.4	8.0	5.4	8.2	5.4	8.7	5.3	9.1	5.2
	12	6.6	4.8	7.3	5.1	7.8	5.4	8.0	5.4	8.2	5.4	8.7	5.3	9.1	5.2
	14	6.6	4.8	7.3	5.1	7.8	5.4	8.0	5.4	8.2	5.4	8.7	5.3	9.1	5.2
	16	6.6	4.8	7.3	5.1	7.8	5.4	8.0	5.4	8.2	5.4	8.7	5.3	9.1	5.2
	18	6.6	4.8	7.3	5.1	7.8	5.4	8.0	5.4	8.2	5.4	8.7	5.3	9.1	5.2
	20	6.6	4.8	7.3	5.1	7.8	5.4	8.0	5.4	8.2	5.4	8.7	5.3	9.1	5.2
	21	6.6	4.8	7.3	5.1	7.8	5.4	8.0	5.4	8.2	5.4	8.7	5.3	9.1	5.2
	23	6.6	4.8	7.3	5.1	7.8	5.4	8.0	5.4	8.2	5.4	8.7	5.3	9.1	5.2
	25	6.6	4.8	7.3	5.1	7.8	5.4	8.0	5.4	8.2	5.4	8.7	5.3	9.1	5.2
	27	6.6	4.8	7.3	5.1	7.8	5.4	8.0	5.4	8.2	5.4	8.7	5.3	9.1	5.2
	29	6.6	4.8	7.3	5.1	7.8	5.4	8.0	5.4	8.2	5.4	8.7	5.3	9.1	5.2
	31	6.6	4.8	7.3	5.1	7.8	5.4	8.0	5.4	8.2	5.4	8.7	5.3	9.1	5.2
	33	6.6	4.8	7.3	5.1	7.8	5.4	8.0	5.4	8.2	5.4	8.7	5.3	9.1	5.2
	35	6.6	4.8	7.3	5.1	7.8	5.4	8.0	5.4	8.2	5.4	8.7	5.3	9.1	5.2
	37	6.4	4.6	7.0	4.9	7.5	5.3	7.8	5.2	8.0	5.2	8.5	5.2	8.8	5.1
	39	6.1	4.4	6.7	4.7	7.2	5.0	7.4	5.0	7.6	5.0	8.1	5.0	8.5	4.8
	40	5.9	4.3	6.5	4.6	7.0	4.9	7.2	4.9	7.4	4.9	7.8	4.8	8.2	4.7
42	5.5	4.0	6.1	4.3	6.5	4.5	6.7	4.5	6.9	4.5	7.3	4.5	7.6	4.4	
44	5.0	3.6	5.5	3.9	5.9	4.1	6.1	4.1	6.3	4.1	6.6	4.1	6.9	4.0	
46	4.4	3.2	4.9	3.4	5.2	3.6	5.4	3.6	5.5	3.6	5.9	3.6	6.1	3.5	



Under Ceiling Type (MMC-AP ___7HP-E)

TC : Total capacity [kW] SHC : Sensible capacity [kW]

unit size	outdoor air temp. °CDB	indoor air temp.													
		14°CWB		16°CWB		18°CWB		19°CWB		20°CWB		22°CWB		24°CWB	
		20°CDB	23°CDB	26°CDB	27°CDB	28°CDB	30°CDB	32°CDB	TC	SHC	TC	SHC	TC	SHC	TC
015	10	3.7	3.0	4.1	3.2	4.4	3.4	4.5	3.4	4.6	3.4	4.9	3.4	5.1	3.3
	12	3.7	3.0	4.1	3.2	4.4	3.4	4.5	3.4	4.6	3.4	4.9	3.4	5.1	3.3
	14	3.7	3.0	4.1	3.2	4.4	3.4	4.5	3.4	4.6	3.4	4.9	3.4	5.1	3.3
	16	3.7	3.0	4.1	3.2	4.4	3.4	4.5	3.4	4.6	3.4	4.9	3.4	5.1	3.3
	18	3.7	3.0	4.1	3.2	4.4	3.4	4.5	3.4	4.6	3.4	4.9	3.4	5.1	3.3
	20	3.7	3.0	4.1	3.2	4.4	3.4	4.5	3.4	4.6	3.4	4.9	3.4	5.1	3.3
	21	3.7	3.0	4.1	3.2	4.4	3.4	4.5	3.4	4.6	3.4	4.9	3.4	5.1	3.3
	23	3.7	3.0	4.1	3.2	4.4	3.4	4.5	3.4	4.6	3.4	4.9	3.4	5.1	3.3
	25	3.7	3.0	4.1	3.2	4.4	3.4	4.5	3.4	4.6	3.4	4.9	3.4	5.1	3.3
	27	3.7	3.0	4.1	3.2	4.4	3.4	4.5	3.4	4.6	3.4	4.9	3.4	5.1	3.3
	29	3.7	3.0	4.1	3.2	4.4	3.4	4.5	3.4	4.6	3.4	4.9	3.4	5.1	3.3
	31	3.7	3.0	4.1	3.2	4.4	3.4	4.5	3.4	4.6	3.4	4.9	3.4	5.1	3.3
	33	3.7	3.0	4.1	3.2	4.4	3.4	4.5	3.4	4.6	3.4	4.9	3.4	5.1	3.3
	35	3.7	3.0	4.1	3.2	4.4	3.4	4.5	3.4	4.6	3.4	4.9	3.4	5.1	3.3
	37	3.6	2.9	4.0	3.1	4.2	3.3	4.4	3.3	4.5	3.3	4.8	3.3	5.0	3.2
	39	3.4	2.8	3.8	3.0	4.0	3.2	4.2	3.2	4.3	3.2	4.5	3.1	4.8	3.0
40	3.3	2.7	3.7	2.9	3.9	3.1	4.1	3.1	4.2	3.1	4.4	3.0	4.6	3.0	
42	3.1	2.5	3.4	2.7	3.7	2.9	3.8	2.8	3.9	2.8	4.1	2.8	4.3	2.8	
44	2.8	2.3	3.1	2.4	3.3	2.6	3.4	2.6	3.5	2.6	3.7	2.6	3.9	2.5	
46	2.5	2.0	2.7	2.2	2.9	2.3	3.0	2.3	3.1	2.3	3.3	2.3	3.4	2.2	
018	10	4.6	3.7	5.1	3.9	5.4	4.2	5.6	4.2	5.8	4.1	6.1	4.1	6.4	4.0
	12	4.6	3.7	5.1	3.9	5.4	4.2	5.6	4.2	5.8	4.1	6.1	4.1	6.4	4.0
	14	4.6	3.7	5.1	3.9	5.4	4.2	5.6	4.2	5.8	4.1	6.1	4.1	6.4	4.0
	16	4.6	3.7	5.1	3.9	5.4	4.2	5.6	4.2	5.8	4.1	6.1	4.1	6.4	4.0
	18	4.6	3.7	5.1	3.9	5.4	4.2	5.6	4.2	5.8	4.1	6.1	4.1	6.4	4.0
	20	4.6	3.7	5.1	3.9	5.4	4.2	5.6	4.2	5.8	4.1	6.1	4.1	6.4	4.0
	21	4.6	3.7	5.1	3.9	5.4	4.2	5.6	4.2	5.8	4.1	6.1	4.1	6.4	4.0
	23	4.6	3.7	5.1	3.9	5.4	4.2	5.6	4.2	5.8	4.1	6.1	4.1	6.4	4.0
	25	4.6	3.7	5.1	3.9	5.4	4.2	5.6	4.2	5.8	4.1	6.1	4.1	6.4	4.0
	27	4.6	3.7	5.1	3.9	5.4	4.2	5.6	4.2	5.8	4.1	6.1	4.1	6.4	4.0
	29	4.6	3.7	5.1	3.9	5.4	4.2	5.6	4.2	5.8	4.1	6.1	4.1	6.4	4.0
	31	4.6	3.7	5.1	3.9	5.4	4.2	5.6	4.2	5.8	4.1	6.1	4.1	6.4	4.0
	33	4.6	3.7	5.1	3.9	5.4	4.2	5.6	4.2	5.8	4.1	6.1	4.1	6.4	4.0
	35	4.6	3.7	5.1	3.9	5.4	4.2	5.6	4.2	5.8	4.1	6.1	4.1	6.4	4.0
	37	4.5	3.6	4.9	3.8	5.3	4.0	5.4	4.0	5.6	4.0	5.9	4.0	6.2	3.9
	39	4.3	3.4	4.7	3.6	5.0	3.9	5.2	3.8	5.3	3.8	5.7	3.8	5.9	3.7
40	4.1	3.3	4.6	3.5	4.9	3.7	5.0	3.7	5.2	3.7	5.5	3.7	5.7	3.6	
42	3.8	3.1	4.3	3.3	4.5	3.5	4.7	3.5	4.8	3.5	5.1	3.4	5.3	3.4	
44	3.5	2.8	3.9	3.0	4.1	3.2	4.3	3.2	4.4	3.2	4.6	3.1	4.9	3.1	
46	3.1	2.5	3.4	2.6	3.7	2.8	3.8	2.8	3.9	2.8	4.1	2.8	4.3	2.7	
024	10	5.8	4.7	6.4	5.0	6.9	5.3	7.1	5.3	7.3	5.3	7.7	5.3	8.1	5.1
	12	5.8	4.7	6.4	5.0	6.9	5.3	7.1	5.3	7.3	5.3	7.7	5.3	8.1	5.1
	14	5.8	4.7	6.4	5.0	6.9	5.3	7.1	5.3	7.3	5.3	7.7	5.3	8.1	5.1
	16	5.8	4.7	6.4	5.0	6.9	5.3	7.1	5.3	7.3	5.3	7.7	5.3	8.1	5.1
	18	5.8	4.7	6.4	5.0	6.9	5.3	7.1	5.3	7.3	5.3	7.7	5.3	8.1	5.1
	20	5.8	4.7	6.4	5.0	6.9	5.3	7.1	5.3	7.3	5.3	7.7	5.3	8.1	5.1
	21	5.8	4.7	6.4	5.0	6.9	5.3	7.1	5.3	7.3	5.3	7.7	5.3	8.1	5.1
	23	5.8	4.7	6.4	5.0	6.9	5.3	7.1	5.3	7.3	5.3	7.7	5.3	8.1	5.1
	25	5.8	4.7	6.4	5.0	6.9	5.3	7.1	5.3	7.3	5.3	7.7	5.3	8.1	5.1
	27	5.8	4.7	6.4	5.0	6.9	5.3	7.1	5.3	7.3	5.3	7.7	5.3	8.1	5.1
	29	5.8	4.7	6.4	5.0	6.9	5.3	7.1	5.3	7.3	5.3	7.7	5.3	8.1	5.1
	31	5.8	4.7	6.4	5.0	6.9	5.3	7.1	5.3	7.3	5.3	7.7	5.3	8.1	5.1
	33	5.8	4.7	6.4	5.0	6.9	5.3	7.1	5.3	7.3	5.3	7.7	5.3	8.1	5.1
	35	5.8	4.7	6.4	5.0	6.9	5.3	7.1	5.3	7.3	5.3	7.7	5.3	8.1	5.1
	37	5.7	4.6	6.3	4.9	6.7	5.2	6.9	5.1	7.1	5.1	7.5	5.1	7.9	5.0
	39	5.4	4.4	6.0	4.6	6.4	4.9	6.6	4.9	6.8	4.9	7.2	4.9	7.5	4.8
40	5.2	4.2	5.8	4.5	6.2	4.8	6.4	4.8	6.6	4.8	7.0	4.7	7.3	4.6	
42	4.9	3.9	5.4	4.2	5.8	4.5	5.9	4.4	6.1	4.4	6.5	4.4	6.8	4.3	
44	4.4	3.6	4.9	3.8	5.2	4.0	5.4	4.0	5.6	4.0	5.9	4.0	6.2	3.9	
46	3.9	3.2	4.3	3.4	4.6	3.6	4.8	3.6	4.9	3.6	5.2	3.5	5.4	3.4	



Under Ceiling Type (MMC-AP ___7HP-E)

TC : Total capacity [kW] SHC : Sensible capacity [kW]

unit size	outdoor air temp. °CDB	indoor air temp.													
		14°CWB		16°CWB		18°CWB		19°CWB		20°CWB		22°CWB		24°CWB	
		20°CDB	23°CDB	26°CDB	27°CDB	28°CDB	30°CDB	32°CDB	TC	SHC	TC	SHC	TC	SHC	TC
027	10	6.6	5.1	7.3	5.5	7.8	5.8	8.0	5.8	8.2	5.8	8.7	5.7	9.1	5.6
	12	6.6	5.1	7.3	5.5	7.8	5.8	8.0	5.8	8.2	5.8	8.7	5.7	9.1	5.6
	14	6.6	5.1	7.3	5.5	7.8	5.8	8.0	5.8	8.2	5.8	8.7	5.7	9.1	5.6
	16	6.6	5.1	7.3	5.5	7.8	5.8	8.0	5.8	8.2	5.8	8.7	5.7	9.1	5.6
	18	6.6	5.1	7.3	5.5	7.8	5.8	8.0	5.8	8.2	5.8	8.7	5.7	9.1	5.6
	20	6.6	5.1	7.3	5.5	7.8	5.8	8.0	5.8	8.2	5.8	8.7	5.7	9.1	5.6
	21	6.6	5.1	7.3	5.5	7.8	5.8	8.0	5.8	8.2	5.8	8.7	5.7	9.1	5.6
	23	6.6	5.1	7.3	5.5	7.8	5.8	8.0	5.8	8.2	5.8	8.7	5.7	9.1	5.6
	25	6.6	5.1	7.3	5.5	7.8	5.8	8.0	5.8	8.2	5.8	8.7	5.7	9.1	5.6
	27	6.6	5.1	7.3	5.5	7.8	5.8	8.0	5.8	8.2	5.8	8.7	5.7	9.1	5.6
	29	6.6	5.1	7.3	5.5	7.8	5.8	8.0	5.8	8.2	5.8	8.7	5.7	9.1	5.6
	31	6.6	5.1	7.3	5.5	7.8	5.8	8.0	5.8	8.2	5.8	8.7	5.7	9.1	5.6
	33	6.6	5.1	7.3	5.5	7.8	5.8	8.0	5.8	8.2	5.8	8.7	5.7	9.1	5.6
	35	6.6	5.1	7.3	5.5	7.8	5.8	8.0	5.8	8.2	5.8	8.7	5.7	9.1	5.6
	37	6.4	5.0	7.0	5.3	7.5	5.6	7.8	5.6	8.0	5.6	8.5	5.6	8.8	5.4
	39	6.1	4.8	6.7	5.1	7.2	5.4	7.4	5.4	7.6	5.4	8.1	5.3	8.5	5.2
40	5.9	4.6	6.5	4.9	7.0	5.2	7.2	5.2	7.4	5.2	7.8	5.2	8.2	5.1	
42	5.5	4.3	6.1	4.6	6.5	4.9	6.7	4.9	6.9	4.9	7.3	4.8	7.6	4.7	
44	5.0	3.9	5.5	4.2	5.9	4.4	6.1	4.4	6.3	4.4	6.6	4.4	6.9	4.3	
46	4.4	3.5	4.9	3.7	5.2	3.9	5.4	3.9	5.5	3.9	5.9	3.9	6.1	3.8	
036	10	9.2	7.3	10.2	7.7	10.9	8.2	11.2	8.2	11.5	8.2	12.2	8.1	12.8	7.9
	12	9.2	7.3	10.2	7.7	10.9	8.2	11.2	8.2	11.5	8.2	12.2	8.1	12.8	7.9
	14	9.2	7.3	10.2	7.7	10.9	8.2	11.2	8.2	11.5	8.2	12.2	8.1	12.8	7.9
	16	9.2	7.3	10.2	7.7	10.9	8.2	11.2	8.2	11.5	8.2	12.2	8.1	12.8	7.9
	18	9.2	7.3	10.2	7.7	10.9	8.2	11.2	8.2	11.5	8.2	12.2	8.1	12.8	7.9
	20	9.2	7.3	10.2	7.7	10.9	8.2	11.2	8.2	11.5	8.2	12.2	8.1	12.8	7.9
	21	9.2	7.3	10.2	7.7	10.9	8.2	11.2	8.2	11.5	8.2	12.2	8.1	12.8	7.9
	23	9.2	7.3	10.2	7.7	10.9	8.2	11.2	8.2	11.5	8.2	12.2	8.1	12.8	7.9
	25	9.2	7.3	10.2	7.7	10.9	8.2	11.2	8.2	11.5	8.2	12.2	8.1	12.8	7.9
	27	9.2	7.3	10.2	7.7	10.9	8.2	11.2	8.2	11.5	8.2	12.2	8.1	12.8	7.9
	29	9.2	7.3	10.2	7.7	10.9	8.2	11.2	8.2	11.5	8.2	12.2	8.1	12.8	7.9
	31	9.2	7.3	10.2	7.7	10.9	8.2	11.2	8.2	11.5	8.2	12.2	8.1	12.8	7.9
	33	9.2	7.3	10.2	7.7	10.9	8.2	11.2	8.2	11.5	8.2	12.2	8.1	12.8	7.9
	35	9.2	7.3	10.2	7.7	10.9	8.2	11.2	8.2	11.5	8.2	12.2	8.1	12.8	7.9
	37	8.9	7.1	9.9	7.5	10.5	8.0	10.9	8.0	11.2	8.0	11.8	7.9	12.4	7.7
	39	8.5	6.7	9.4	7.2	10.1	7.6	10.4	7.6	10.7	7.6	11.3	7.5	11.8	7.4
40	8.3	6.5	9.2	7.0	9.8	7.4	10.1	7.4	10.4	7.4	11.0	7.3	11.5	7.1	
42	7.7	6.1	8.5	6.5	9.1	6.9	9.4	6.9	9.7	6.9	10.2	6.8	10.7	6.6	
44	7.0	5.5	7.7	5.9	8.3	6.3	8.5	6.2	8.8	6.2	9.3	6.2	9.7	6.0	
46	6.2	4.9	6.8	5.2	7.3	5.5	7.5	5.5	7.8	5.5	8.2	5.5	8.6	5.3	
048	10	11.5	8.8	12.7	9.3	13.6	9.9	14.0	9.9	14.4	9.9	15.3	9.8	16.0	9.6
	12	11.5	8.8	12.7	9.3	13.6	9.9	14.0	9.9	14.4	9.9	15.3	9.8	16.0	9.6
	14	11.5	8.8	12.7	9.3	13.6	9.9	14.0	9.9	14.4	9.9	15.3	9.8	16.0	9.6
	16	11.5	8.8	12.7	9.3	13.6	9.9	14.0	9.9	14.4	9.9	15.3	9.8	16.0	9.6
	18	11.5	8.8	12.7	9.3	13.6	9.9	14.0	9.9	14.4	9.9	15.3	9.8	16.0	9.6
	20	11.5	8.8	12.7	9.3	13.6	9.9	14.0	9.9	14.4	9.9	15.3	9.8	16.0	9.6
	21	11.5	8.8	12.7	9.3	13.6	9.9	14.0	9.9	14.4	9.9	15.3	9.8	16.0	9.6
	23	11.5	8.8	12.7	9.3	13.6	9.9	14.0	9.9	14.4	9.9	15.3	9.8	16.0	9.6
	25	11.5	8.8	12.7	9.3	13.6	9.9	14.0	9.9	14.4	9.9	15.3	9.8	16.0	9.6
	27	11.5	8.8	12.7	9.3	13.6	9.9	14.0	9.9	14.4	9.9	15.3	9.8	16.0	9.6
	29	11.5	8.8	12.7	9.3	13.6	9.9	14.0	9.9	14.4	9.9	15.3	9.8	16.0	9.6
	31	11.5	8.8	12.7	9.3	13.6	9.9	14.0	9.9	14.4	9.9	15.3	9.8	16.0	9.6
	33	11.5	8.8	12.7	9.3	13.6	9.9	14.0	9.9	14.4	9.9	15.3	9.8	16.0	9.6
	35	11.5	8.8	12.7	9.3	13.6	9.9	14.0	9.9	14.4	9.9	15.3	9.8	16.0	9.6
	37	11.1	8.5	12.3	9.1	13.2	9.6	13.6	9.6	14.0	9.6	14.8	9.5	15.5	9.3
	39	10.7	8.1	11.8	8.7	12.6	9.2	13.0	9.2	13.4	9.2	14.1	9.1	14.8	8.9
40	10.3	7.9	11.4	8.4	12.2	8.9	12.6	8.9	13.0	8.9	13.7	8.8	14.4	8.6	
42	9.6	7.3	10.6	7.8	11.4	8.3	11.7	8.3	12.1	8.3	12.8	8.2	13.4	8.0	
44	8.8	6.7	9.7	7.1	10.3	7.6	10.7	7.5	11.0	7.5	11.6	7.5	12.2	7.3	
46	7.7	5.9	8.5	6.3	9.1	6.7	9.4	6.7	9.7	6.7	10.3	6.6	10.7	6.4	



High Wall Type (MMK-AP__3H)

TC : Total capacity [kW] SHC : Sensible capacity [kW]

unit size	outdoor air temp. °CDB	indoor air temp.													
		14°CWB		16°CWB		18°CWB		19°CWB		20°CWB		22°CWB		24°CWB	
		20°CDB	23°CDB	26°CDB	27°CDB	28°CDB	30°CDB	32°CDB	TC	SHC	TC	SHC	TC	SHC	TC
007	10	1.8	1.5	2.0	1.6	2.1	1.7	2.2	1.7	2.3	1.7	2.4	1.7	2.5	1.6
	12	1.8	1.5	2.0	1.6	2.1	1.7	2.2	1.7	2.3	1.7	2.4	1.7	2.5	1.6
	14	1.8	1.5	2.0	1.6	2.1	1.7	2.2	1.7	2.3	1.7	2.4	1.7	2.5	1.6
	16	1.8	1.5	2.0	1.6	2.1	1.7	2.2	1.7	2.3	1.7	2.4	1.7	2.5	1.6
	18	1.8	1.5	2.0	1.6	2.1	1.7	2.2	1.7	2.3	1.7	2.4	1.7	2.5	1.6
	20	1.8	1.5	2.0	1.6	2.1	1.7	2.2	1.7	2.3	1.7	2.4	1.7	2.5	1.6
	21	1.8	1.5	2.0	1.6	2.1	1.7	2.2	1.7	2.3	1.7	2.4	1.7	2.5	1.6
	23	1.8	1.5	2.0	1.6	2.1	1.7	2.2	1.7	2.3	1.7	2.4	1.7	2.5	1.6
	25	1.8	1.5	2.0	1.6	2.1	1.7	2.2	1.7	2.3	1.7	2.4	1.7	2.5	1.6
	27	1.8	1.5	2.0	1.6	2.1	1.7	2.2	1.7	2.3	1.7	2.4	1.7	2.5	1.6
	29	1.8	1.5	2.0	1.6	2.1	1.7	2.2	1.7	2.3	1.7	2.4	1.7	2.5	1.6
	31	1.8	1.5	2.0	1.6	2.1	1.7	2.2	1.7	2.3	1.7	2.4	1.7	2.5	1.6
	33	1.8	1.5	2.0	1.6	2.1	1.7	2.2	1.7	2.3	1.7	2.4	1.7	2.5	1.6
	35	1.8	1.5	2.0	1.6	2.1	1.7	2.2	1.7	2.3	1.7	2.4	1.7	2.5	1.6
	37	1.8	1.5	1.9	1.6	2.1	1.7	2.1	1.6	2.2	1.6	2.3	1.6	2.4	1.6
	39	1.7	1.4	1.9	1.5	2.0	1.6	2.0	1.6	2.1	1.6	2.2	1.6	2.3	1.5
	40	1.6	1.4	1.8	1.4	1.9	1.5	2.0	1.5	2.0	1.5	2.2	1.5	2.3	1.5
42	1.5	1.3	1.7	1.3	1.8	1.4	1.8	1.4	1.9	1.4	2.0	1.4	2.1	1.4	
44	1.4	1.1	1.5	1.2	1.6	1.3	1.7	1.3	1.7	1.3	1.8	1.3	1.9	1.3	
46	1.2	1.0	1.3	1.1	1.4	1.1	1.5	1.1	1.5	1.1	1.6	1.1	1.7	1.1	
009	10	2.3	1.9	2.5	2.0	2.7	2.1	2.8	2.1	2.9	2.1	3.1	2.1	3.2	2.0
	12	2.3	1.9	2.5	2.0	2.7	2.1	2.8	2.1	2.9	2.1	3.1	2.1	3.2	2.0
	14	2.3	1.9	2.5	2.0	2.7	2.1	2.8	2.1	2.9	2.1	3.1	2.1	3.2	2.0
	16	2.3	1.9	2.5	2.0	2.7	2.1	2.8	2.1	2.9	2.1	3.1	2.1	3.2	2.0
	18	2.3	1.9	2.5	2.0	2.7	2.1	2.8	2.1	2.9	2.1	3.1	2.1	3.2	2.0
	20	2.3	1.9	2.5	2.0	2.7	2.1	2.8	2.1	2.9	2.1	3.1	2.1	3.2	2.0
	21	2.3	1.9	2.5	2.0	2.7	2.1	2.8	2.1	2.9	2.1	3.1	2.1	3.2	2.0
	23	2.3	1.9	2.5	2.0	2.7	2.1	2.8	2.1	2.9	2.1	3.1	2.1	3.2	2.0
	25	2.3	1.9	2.5	2.0	2.7	2.1	2.8	2.1	2.9	2.1	3.1	2.1	3.2	2.0
	27	2.3	1.9	2.5	2.0	2.7	2.1	2.8	2.1	2.9	2.1	3.1	2.1	3.2	2.0
	29	2.3	1.9	2.5	2.0	2.7	2.1	2.8	2.1	2.9	2.1	3.1	2.1	3.2	2.0
	31	2.3	1.9	2.5	2.0	2.7	2.1	2.8	2.1	2.9	2.1	3.1	2.1	3.2	2.0
	33	2.3	1.9	2.5	2.0	2.7	2.1	2.8	2.1	2.9	2.1	3.1	2.1	3.2	2.0
	35	2.3	1.9	2.5	2.0	2.7	2.1	2.8	2.1	2.9	2.1	3.1	2.1	3.2	2.0
	37	2.2	1.8	2.5	1.9	2.6	2.0	2.7	2.0	2.8	2.0	3.0	2.0	3.1	2.0
	39	2.1	1.7	2.4	1.8	2.5	2.0	2.6	1.9	2.7	1.9	2.8	1.9	3.0	1.9
	40	2.1	1.7	2.3	1.8	2.4	1.9	2.5	1.9	2.6	1.9	2.7	1.9	2.9	1.8
42	1.9	1.6	2.1	1.7	2.3	1.8	2.3	1.8	2.4	1.8	2.6	1.7	2.7	1.7	
44	1.8	1.4	1.9	1.5	2.1	1.6	2.1	1.6	2.2	1.6	2.3	1.6	2.4	1.5	
46	1.5	1.3	1.7	1.3	1.8	1.4	1.9	1.4	1.9	1.4	2.1	1.4	2.1	1.4	
012	10	3.0	2.3	3.3	2.5	3.5	2.6	3.6	2.6	3.7	2.6	3.9	2.6	4.1	2.5
	12	3.0	2.3	3.3	2.5	3.5	2.6	3.6	2.6	3.7	2.6	3.9	2.6	4.1	2.5
	14	3.0	2.3	3.3	2.5	3.5	2.6	3.6	2.6	3.7	2.6	3.9	2.6	4.1	2.5
	16	3.0	2.3	3.3	2.5	3.5	2.6	3.6	2.6	3.7	2.6	3.9	2.6	4.1	2.5
	18	3.0	2.3	3.3	2.5	3.5	2.6	3.6	2.6	3.7	2.6	3.9	2.6	4.1	2.5
	20	3.0	2.3	3.3	2.5	3.5	2.6	3.6	2.6	3.7	2.6	3.9	2.6	4.1	2.5
	21	3.0	2.3	3.3	2.5	3.5	2.6	3.6	2.6	3.7	2.6	3.9	2.6	4.1	2.5
	23	3.0	2.3	3.3	2.5	3.5	2.6	3.6	2.6	3.7	2.6	3.9	2.6	4.1	2.5
	25	3.0	2.3	3.3	2.5	3.5	2.6	3.6	2.6	3.7	2.6	3.9	2.6	4.1	2.5
	27	3.0	2.3	3.3	2.5	3.5	2.6	3.6	2.6	3.7	2.6	3.9	2.6	4.1	2.5
	29	3.0	2.3	3.3	2.5	3.5	2.6	3.6	2.6	3.7	2.6	3.9	2.6	4.1	2.5
	31	3.0	2.3	3.3	2.5	3.5	2.6	3.6	2.6	3.7	2.6	3.9	2.6	4.1	2.5
	33	3.0	2.3	3.3	2.5	3.5	2.6	3.6	2.6	3.7	2.6	3.9	2.6	4.1	2.5
	35	3.0	2.3	3.3	2.5	3.5	2.6	3.6	2.6	3.7	2.6	3.9	2.6	4.1	2.5
	37	2.9	2.2	3.2	2.4	3.4	2.5	3.5	2.5	3.6	2.5	3.8	2.5	4.0	2.4
	39	2.7	2.1	3.0	2.3	3.2	2.4	3.3	2.4	3.4	2.4	3.6	2.4	3.8	2.3
	40	2.7	2.1	2.9	2.2	3.1	2.3	3.2	2.3	3.3	2.3	3.5	2.3	3.7	2.3
42	2.5	1.9	2.7	2.1	2.9	2.2	3.0	2.2	3.1	2.2	3.3	2.2	3.4	2.1	
44	2.3	1.8	2.5	1.9	2.7	2.0	2.7	2.0	2.8	2.0	3.0	2.0	3.1	1.9	
46	2.0	1.6	2.2	1.7	2.3	1.8	2.4	1.7	2.5	1.7	2.6	1.7	2.8	1.7	



High Wall Type (MMK-AP 3H)

TC : Total capacity [kW] SHC : Sensible capacity [kW]

unit size	outdoor air temp. °CDB	indoor air temp.													
		14°CWB		16°CWB		18°CWB		19°CWB		20°CWB		22°CWB		24°CWB	
		20°CDB	23°CDB	26°CDB	27°CDB	28°CDB	30°CDB	32°CDB	TC	SHC	TC	SHC	TC	SHC	
015	10	3.7	2.8	4.1	3.0	4.4	3.2	4.5	3.2	4.6	3.2	4.9	3.2	5.1	3.1
	12	3.7	2.8	4.1	3.0	4.4	3.2	4.5	3.2	4.6	3.2	4.9	3.2	5.1	3.1
	14	3.7	2.8	4.1	3.0	4.4	3.2	4.5	3.2	4.6	3.2	4.9	3.2	5.1	3.1
	16	3.7	2.8	4.1	3.0	4.4	3.2	4.5	3.2	4.6	3.2	4.9	3.2	5.1	3.1
	18	3.7	2.8	4.1	3.0	4.4	3.2	4.5	3.2	4.6	3.2	4.9	3.2	5.1	3.1
	20	3.7	2.8	4.1	3.0	4.4	3.2	4.5	3.2	4.6	3.2	4.9	3.2	5.1	3.1
	21	3.7	2.8	4.1	3.0	4.4	3.2	4.5	3.2	4.6	3.2	4.9	3.2	5.1	3.1
	23	3.7	2.8	4.1	3.0	4.4	3.2	4.5	3.2	4.6	3.2	4.9	3.2	5.1	3.1
	25	3.7	2.8	4.1	3.0	4.4	3.2	4.5	3.2	4.6	3.2	4.9	3.2	5.1	3.1
	27	3.7	2.8	4.1	3.0	4.4	3.2	4.5	3.2	4.6	3.2	4.9	3.2	5.1	3.1
	29	3.7	2.8	4.1	3.0	4.4	3.2	4.5	3.2	4.6	3.2	4.9	3.2	5.1	3.1
	31	3.7	2.8	4.1	3.0	4.4	3.2	4.5	3.2	4.6	3.2	4.9	3.2	5.1	3.1
	33	3.7	2.8	4.1	3.0	4.4	3.2	4.5	3.2	4.6	3.2	4.9	3.2	5.1	3.1
	35	3.7	2.8	4.1	3.0	4.4	3.2	4.5	3.2	4.6	3.2	4.9	3.2	5.1	3.1
	37	3.6	2.8	4.0	2.9	4.2	3.1	4.4	3.1	4.5	3.1	4.8	3.1	5.0	3.0
	39	3.4	2.6	3.8	2.8	4.0	3.0	4.2	3.0	4.3	3.0	4.5	2.9	4.8	2.9
40	3.3	2.6	3.7	2.7	3.9	2.9	4.1	2.9	4.2	2.9	4.4	2.9	4.6	2.8	
42	3.1	2.4	3.4	2.5	3.7	2.7	3.8	2.7	3.9	2.7	4.1	2.7	4.3	2.6	
44	2.8	2.2	3.1	2.3	3.3	2.4	3.4	2.4	3.5	2.4	3.7	2.4	3.9	2.4	
46	2.5	1.9	2.7	2.0	2.9	2.2	3.0	2.2	3.1	2.2	3.3	2.1	3.4	2.1	
018	10	4.6	3.5	5.1	3.7	5.4	3.9	5.6	3.9	5.8	3.9	6.1	3.9	6.4	3.8
	12	4.6	3.5	5.1	3.7	5.4	3.9	5.6	3.9	5.8	3.9	6.1	3.9	6.4	3.8
	14	4.6	3.5	5.1	3.7	5.4	3.9	5.6	3.9	5.8	3.9	6.1	3.9	6.4	3.8
	16	4.6	3.5	5.1	3.7	5.4	3.9	5.6	3.9	5.8	3.9	6.1	3.9	6.4	3.8
	18	4.6	3.5	5.1	3.7	5.4	3.9	5.6	3.9	5.8	3.9	6.1	3.9	6.4	3.8
	20	4.6	3.5	5.1	3.7	5.4	3.9	5.6	3.9	5.8	3.9	6.1	3.9	6.4	3.8
	21	4.6	3.5	5.1	3.7	5.4	3.9	5.6	3.9	5.8	3.9	6.1	3.9	6.4	3.8
	23	4.6	3.5	5.1	3.7	5.4	3.9	5.6	3.9	5.8	3.9	6.1	3.9	6.4	3.8
	25	4.6	3.5	5.1	3.7	5.4	3.9	5.6	3.9	5.8	3.9	6.1	3.9	6.4	3.8
	27	4.6	3.5	5.1	3.7	5.4	3.9	5.6	3.9	5.8	3.9	6.1	3.9	6.4	3.8
	29	4.6	3.5	5.1	3.7	5.4	3.9	5.6	3.9	5.8	3.9	6.1	3.9	6.4	3.8
	31	4.6	3.5	5.1	3.7	5.4	3.9	5.6	3.9	5.8	3.9	6.1	3.9	6.4	3.8
	33	4.6	3.5	5.1	3.7	5.4	3.9	5.6	3.9	5.8	3.9	6.1	3.9	6.4	3.8
	35	4.6	3.5	5.1	3.7	5.4	3.9	5.6	3.9	5.8	3.9	6.1	3.9	6.4	3.8
	37	4.5	3.4	4.9	3.6	5.3	3.8	5.4	3.8	5.6	3.8	5.9	3.7	6.2	3.7
	39	4.3	3.2	4.7	3.4	5.0	3.6	5.2	3.6	5.3	3.6	5.7	3.6	5.9	3.5
40	4.1	3.1	4.6	3.3	4.9	3.5	5.0	3.5	5.2	3.5	5.5	3.5	5.7	3.4	
42	3.8	2.9	4.3	3.1	4.5	3.3	4.7	3.3	4.8	3.3	5.1	3.2	5.3	3.2	
44	3.5	2.6	3.9	2.8	4.1	3.0	4.3	3.0	4.4	3.0	4.6	2.9	4.9	2.9	
46	3.1	2.3	3.4	2.5	3.7	2.6	3.8	2.6	3.9	2.6	4.1	2.6	4.3	2.5	
024	10	5.8	4.3	6.4	4.5	6.9	4.8	7.1	4.8	7.3	4.8	7.7	4.8	8.1	4.6
	12	5.8	4.3	6.4	4.5	6.9	4.8	7.1	4.8	7.3	4.8	7.7	4.8	8.1	4.6
	14	5.8	4.3	6.4	4.5	6.9	4.8	7.1	4.8	7.3	4.8	7.7	4.8	8.1	4.6
	16	5.8	4.3	6.4	4.5	6.9	4.8	7.1	4.8	7.3	4.8	7.7	4.8	8.1	4.6
	18	5.8	4.3	6.4	4.5	6.9	4.8	7.1	4.8	7.3	4.8	7.7	4.8	8.1	4.6
	20	5.8	4.3	6.4	4.5	6.9	4.8	7.1	4.8	7.3	4.8	7.7	4.8	8.1	4.6
	21	5.8	4.3	6.4	4.5	6.9	4.8	7.1	4.8	7.3	4.8	7.7	4.8	8.1	4.6
	23	5.8	4.3	6.4	4.5	6.9	4.8	7.1	4.8	7.3	4.8	7.7	4.8	8.1	4.6
	25	5.8	4.3	6.4	4.5	6.9	4.8	7.1	4.8	7.3	4.8	7.7	4.8	8.1	4.6
	27	5.8	4.3	6.4	4.5	6.9	4.8	7.1	4.8	7.3	4.8	7.7	4.8	8.1	4.6
	29	5.8	4.3	6.4	4.5	6.9	4.8	7.1	4.8	7.3	4.8	7.7	4.8	8.1	4.6
	31	5.8	4.3	6.4	4.5	6.9	4.8	7.1	4.8	7.3	4.8	7.7	4.8	8.1	4.6
	33	5.8	4.3	6.4	4.5	6.9	4.8	7.1	4.8	7.3	4.8	7.7	4.8	8.1	4.6
	35	5.8	4.3	6.4	4.5	6.9	4.8	7.1	4.8	7.3	4.8	7.7	4.8	8.1	4.6
	37	5.7	4.1	6.3	4.4	6.7	4.7	6.9	4.7	7.1	4.7	7.5	4.6	7.9	4.5
	39	5.4	3.9	6.0	4.2	6.4	4.5	6.6	4.4	6.8	4.4	7.2	4.4	7.5	4.3
40	5.2	3.8	5.8	4.1	6.2	4.3	6.4	4.3	6.6	4.3	7.0	4.3	7.3	4.2	
42	4.9	3.6	5.4	3.8	5.8	4.0	5.9	4.0	6.1	4.0	6.5	4.0	6.8	3.9	
44	4.4	3.2	4.9	3.5	5.2	3.7	5.4	3.7	5.6	3.7	5.9	3.6	6.2	3.5	
46	3.9	2.9	4.3	3.0	4.6	3.2	4.8	3.2	4.9	3.2	5.2	3.2	5.4	3.1	



Floor Standing Concealed Type (MML-AP___4BH)

TC : Total capacity [kW] SHC : Sensible capacity [kW]

unit size	outdoor air temp. °CDB	indoor air temp.													
		14°CWB		16°CWB		18°CWB		19°CWB		20°CWB		22°CWB		24°CWB	
		20°CDB	23°CDB	26°CDB	27°CDB	28°CDB	30°CDB	32°CDB	TC	SHC	TC	SHC	TC	SHC	TC
007	10	1.8	1.4	2.0	1.5	2.1	1.6	2.2	1.6	2.3	1.6	2.4	1.6	2.5	1.5
	12	1.8	1.4	2.0	1.5	2.1	1.6	2.2	1.6	2.3	1.6	2.4	1.6	2.5	1.5
	14	1.8	1.4	2.0	1.5	2.1	1.6	2.2	1.6	2.3	1.6	2.4	1.6	2.5	1.5
	16	1.8	1.4	2.0	1.5	2.1	1.6	2.2	1.6	2.3	1.6	2.4	1.6	2.5	1.5
	18	1.8	1.4	2.0	1.5	2.1	1.6	2.2	1.6	2.3	1.6	2.4	1.6	2.5	1.5
	20	1.8	1.4	2.0	1.5	2.1	1.6	2.2	1.6	2.3	1.6	2.4	1.6	2.5	1.5
	21	1.8	1.4	2.0	1.5	2.1	1.6	2.2	1.6	2.3	1.6	2.4	1.6	2.5	1.5
	23	1.8	1.4	2.0	1.5	2.1	1.6	2.2	1.6	2.3	1.6	2.4	1.6	2.5	1.5
	25	1.8	1.4	2.0	1.5	2.1	1.6	2.2	1.6	2.3	1.6	2.4	1.6	2.5	1.5
	27	1.8	1.4	2.0	1.5	2.1	1.6	2.2	1.6	2.3	1.6	2.4	1.6	2.5	1.5
	29	1.8	1.4	2.0	1.5	2.1	1.6	2.2	1.6	2.3	1.6	2.4	1.6	2.5	1.5
	31	1.8	1.4	2.0	1.5	2.1	1.6	2.2	1.6	2.3	1.6	2.4	1.6	2.5	1.5
	33	1.8	1.4	2.0	1.5	2.1	1.6	2.2	1.6	2.3	1.6	2.4	1.6	2.5	1.5
	35	1.8	1.4	2.0	1.5	2.1	1.6	2.2	1.6	2.3	1.6	2.4	1.6	2.5	1.5
	37	1.8	1.4	1.9	1.5	2.1	1.6	2.1	1.6	2.2	1.6	2.3	1.5	2.4	1.5
	39	1.7	1.3	1.9	1.4	2.0	1.5	2.0	1.5	2.1	1.5	2.2	1.5	2.3	1.4
40	1.6	1.3	1.8	1.4	1.9	1.4	2.0	1.4	2.0	1.4	2.2	1.4	2.3	1.4	
42	1.5	1.2	1.7	1.3	1.8	1.3	1.8	1.3	1.9	1.3	2.0	1.3	2.1	1.3	
44	1.4	1.1	1.5	1.2	1.6	1.2	1.7	1.2	1.7	1.2	1.8	1.2	1.9	1.2	
46	1.2	1.0	1.3	1.0	1.4	1.1	1.5	1.1	1.5	1.1	1.6	1.1	1.7	1.0	
009	10	2.3	1.8	2.5	1.9	2.7	2.0	2.8	2.0	2.9	2.0	3.1	2.0	3.2	1.9
	12	2.3	1.8	2.5	1.9	2.7	2.0	2.8	2.0	2.9	2.0	3.1	2.0	3.2	1.9
	14	2.3	1.8	2.5	1.9	2.7	2.0	2.8	2.0	2.9	2.0	3.1	2.0	3.2	1.9
	16	2.3	1.8	2.5	1.9	2.7	2.0	2.8	2.0	2.9	2.0	3.1	2.0	3.2	1.9
	18	2.3	1.8	2.5	1.9	2.7	2.0	2.8	2.0	2.9	2.0	3.1	2.0	3.2	1.9
	20	2.3	1.8	2.5	1.9	2.7	2.0	2.8	2.0	2.9	2.0	3.1	2.0	3.2	1.9
	21	2.3	1.8	2.5	1.9	2.7	2.0	2.8	2.0	2.9	2.0	3.1	2.0	3.2	1.9
	23	2.3	1.8	2.5	1.9	2.7	2.0	2.8	2.0	2.9	2.0	3.1	2.0	3.2	1.9
	25	2.3	1.8	2.5	1.9	2.7	2.0	2.8	2.0	2.9	2.0	3.1	2.0	3.2	1.9
	27	2.3	1.8	2.5	1.9	2.7	2.0	2.8	2.0	2.9	2.0	3.1	2.0	3.2	1.9
	29	2.3	1.8	2.5	1.9	2.7	2.0	2.8	2.0	2.9	2.0	3.1	2.0	3.2	1.9
	31	2.3	1.8	2.5	1.9	2.7	2.0	2.8	2.0	2.9	2.0	3.1	2.0	3.2	1.9
	33	2.3	1.8	2.5	1.9	2.7	2.0	2.8	2.0	2.9	2.0	3.1	2.0	3.2	1.9
	35	2.3	1.8	2.5	1.9	2.7	2.0	2.8	2.0	2.9	2.0	3.1	2.0	3.2	1.9
	37	2.2	1.7	2.5	1.8	2.6	1.9	2.7	1.9	2.8	1.9	3.0	1.9	3.1	1.9
	39	2.1	1.6	2.4	1.8	2.5	1.9	2.6	1.9	2.7	1.9	2.8	1.8	3.0	1.8
40	2.1	1.6	2.3	1.7	2.4	1.8	2.5	1.8	2.6	1.8	2.7	1.8	2.9	1.7	
42	1.9	1.5	2.1	1.6	2.3	1.7	2.3	1.7	2.4	1.7	2.6	1.7	2.7	1.6	
44	1.8	1.4	1.9	1.4	2.1	1.5	2.1	1.5	2.2	1.5	2.3	1.5	2.4	1.5	
46	1.5	1.2	1.7	1.3	1.8	1.3	1.9	1.3	1.9	1.3	2.1	1.3	2.1	1.3	
012	10	3.0	2.1	3.3	2.3	3.5	2.4	3.6	2.4	3.7	2.4	3.9	2.4	4.1	2.3
	12	3.0	2.1	3.3	2.3	3.5	2.4	3.6	2.4	3.7	2.4	3.9	2.4	4.1	2.3
	14	3.0	2.1	3.3	2.3	3.5	2.4	3.6	2.4	3.7	2.4	3.9	2.4	4.1	2.3
	16	3.0	2.1	3.3	2.3	3.5	2.4	3.6	2.4	3.7	2.4	3.9	2.4	4.1	2.3
	18	3.0	2.1	3.3	2.3	3.5	2.4	3.6	2.4	3.7	2.4	3.9	2.4	4.1	2.3
	20	3.0	2.1	3.3	2.3	3.5	2.4	3.6	2.4	3.7	2.4	3.9	2.4	4.1	2.3
	21	3.0	2.1	3.3	2.3	3.5	2.4	3.6	2.4	3.7	2.4	3.9	2.4	4.1	2.3
	23	3.0	2.1	3.3	2.3	3.5	2.4	3.6	2.4	3.7	2.4	3.9	2.4	4.1	2.3
	25	3.0	2.1	3.3	2.3	3.5	2.4	3.6	2.4	3.7	2.4	3.9	2.4	4.1	2.3
	27	3.0	2.1	3.3	2.3	3.5	2.4	3.6	2.4	3.7	2.4	3.9	2.4	4.1	2.3
	29	3.0	2.1	3.3	2.3	3.5	2.4	3.6	2.4	3.7	2.4	3.9	2.4	4.1	2.3
	31	3.0	2.1	3.3	2.3	3.5	2.4	3.6	2.4	3.7	2.4	3.9	2.4	4.1	2.3
	33	3.0	2.1	3.3	2.3	3.5	2.4	3.6	2.4	3.7	2.4	3.9	2.4	4.1	2.3
	35	3.0	2.1	3.3	2.3	3.5	2.4	3.6	2.4	3.7	2.4	3.9	2.4	4.1	2.3
	37	2.9	2.1	3.2	2.2	3.4	2.3	3.5	2.3	3.6	2.3	3.8	2.3	4.0	2.3
	39	2.7	2.0	3.0	2.1	3.2	2.2	3.3	2.2	3.4	2.2	3.6	2.2	3.8	2.2
40	2.7	1.9	2.9	2.0	3.1	2.2	3.2	2.2	3.3	2.2	3.5	2.1	3.7	2.1	
42	2.5	1.8	2.7	1.9	2.9	2.0	3.0	2.0	3.1	2.0	3.3	2.0	3.4	1.9	
44	2.3	1.6	2.5	1.7	2.7	1.8	2.7	1.8	2.8	1.8	3.0	1.8	3.1	1.8	
46	2.0	1.4	2.2	1.5	2.3	1.6	2.4	1.6	2.5	1.6	2.6	1.6	2.8	1.6	



Floor Standing Concealed Type (MML-AP___4BH-E)

TC : Total capacity [kW] SHC : Sensible capacity [kW]

unit size	outdoor air temp. °CDB	indoor air temp.													
		14°CWB		16°CWB		18°CWB		19°CWB		20°CWB		22°CWB		24°CWB	
		20°CDB	23°CDB	26°CDB	27°CDB	28°CDB	30°CDB	32°CDB	TC	SHC	TC	SHC	TC	SHC	TC
015	10	3.7	2.9	4.1	3.1	4.4	3.3	4.5	3.3	4.6	3.3	4.9	3.3	5.1	3.2
	12	3.7	2.9	4.1	3.1	4.4	3.3	4.5	3.3	4.6	3.3	4.9	3.3	5.1	3.2
	14	3.7	2.9	4.1	3.1	4.4	3.3	4.5	3.3	4.6	3.3	4.9	3.3	5.1	3.2
	16	3.7	2.9	4.1	3.1	4.4	3.3	4.5	3.3	4.6	3.3	4.9	3.3	5.1	3.2
	18	3.7	2.9	4.1	3.1	4.4	3.3	4.5	3.3	4.6	3.3	4.9	3.3	5.1	3.2
	20	3.7	2.9	4.1	3.1	4.4	3.3	4.5	3.3	4.6	3.3	4.9	3.3	5.1	3.2
	21	3.7	2.9	4.1	3.1	4.4	3.3	4.5	3.3	4.6	3.3	4.9	3.3	5.1	3.2
	23	3.7	2.9	4.1	3.1	4.4	3.3	4.5	3.3	4.6	3.3	4.9	3.3	5.1	3.2
	25	3.7	2.9	4.1	3.1	4.4	3.3	4.5	3.3	4.6	3.3	4.9	3.3	5.1	3.2
	27	3.7	2.9	4.1	3.1	4.4	3.3	4.5	3.3	4.6	3.3	4.9	3.3	5.1	3.2
	29	3.7	2.9	4.1	3.1	4.4	3.3	4.5	3.3	4.6	3.3	4.9	3.3	5.1	3.2
	31	3.7	2.9	4.1	3.1	4.4	3.3	4.5	3.3	4.6	3.3	4.9	3.3	5.1	3.2
	33	3.7	2.9	4.1	3.1	4.4	3.3	4.5	3.3	4.6	3.3	4.9	3.3	5.1	3.2
	35	3.7	2.9	4.1	3.1	4.4	3.3	4.5	3.3	4.6	3.3	4.9	3.3	5.1	3.2
	37	3.6	2.8	4.0	3.0	4.2	3.2	4.4	3.2	4.5	3.2	4.8	3.2	5.0	3.1
	39	3.4	2.7	3.8	2.9	4.0	3.1	4.2	3.1	4.3	3.1	4.5	3.0	4.8	3.0
40	3.3	2.6	3.7	2.8	3.9	3.0	4.1	3.0	4.2	3.0	4.4	2.9	4.6	2.9	
42	3.1	2.4	3.4	2.6	3.7	2.8	3.8	2.8	3.9	2.8	4.1	2.7	4.3	2.7	
44	2.8	2.2	3.1	2.4	3.3	2.5	3.4	2.5	3.5	2.5	3.7	2.5	3.9	2.4	
46	2.5	2.0	2.7	2.1	2.9	2.2	3.0	2.2	3.1	2.2	3.3	2.2	3.4	2.1	
018	10	4.6	3.4	5.1	3.6	5.4	3.8	5.6	3.8	5.8	3.8	6.1	3.8	6.4	3.7
	12	4.6	3.4	5.1	3.6	5.4	3.8	5.6	3.8	5.8	3.8	6.1	3.8	6.4	3.7
	14	4.6	3.4	5.1	3.6	5.4	3.8	5.6	3.8	5.8	3.8	6.1	3.8	6.4	3.7
	16	4.6	3.4	5.1	3.6	5.4	3.8	5.6	3.8	5.8	3.8	6.1	3.8	6.4	3.7
	18	4.6	3.4	5.1	3.6	5.4	3.8	5.6	3.8	5.8	3.8	6.1	3.8	6.4	3.7
	20	4.6	3.4	5.1	3.6	5.4	3.8	5.6	3.8	5.8	3.8	6.1	3.8	6.4	3.7
	21	4.6	3.4	5.1	3.6	5.4	3.8	5.6	3.8	5.8	3.8	6.1	3.8	6.4	3.7
	23	4.6	3.4	5.1	3.6	5.4	3.8	5.6	3.8	5.8	3.8	6.1	3.8	6.4	3.7
	25	4.6	3.4	5.1	3.6	5.4	3.8	5.6	3.8	5.8	3.8	6.1	3.8	6.4	3.7
	27	4.6	3.4	5.1	3.6	5.4	3.8	5.6	3.8	5.8	3.8	6.1	3.8	6.4	3.7
	29	4.6	3.4	5.1	3.6	5.4	3.8	5.6	3.8	5.8	3.8	6.1	3.8	6.4	3.7
	31	4.6	3.4	5.1	3.6	5.4	3.8	5.6	3.8	5.8	3.8	6.1	3.8	6.4	3.7
	33	4.6	3.4	5.1	3.6	5.4	3.8	5.6	3.8	5.8	3.8	6.1	3.8	6.4	3.7
	35	4.6	3.4	5.1	3.6	5.4	3.8	5.6	3.8	5.8	3.8	6.1	3.8	6.4	3.7
	37	4.5	3.3	4.9	3.5	5.3	3.7	5.4	3.7	5.6	3.7	5.9	3.7	6.2	3.6
	39	4.3	3.1	4.7	3.3	5.0	3.5	5.2	3.5	5.3	3.5	5.7	3.5	5.9	3.4
40	4.1	3.0	4.6	3.2	4.9	3.4	5.0	3.4	5.2	3.4	5.5	3.4	5.7	3.3	
42	3.8	2.8	4.3	3.0	4.5	3.2	4.7	3.2	4.8	3.2	5.1	3.2	5.3	3.1	
44	3.5	2.6	3.9	2.7	4.1	2.9	4.3	2.9	4.4	2.9	4.6	2.9	4.9	2.8	
46	3.1	2.3	3.4	2.4	3.7	2.6	3.8	2.6	3.9	2.6	4.1	2.5	4.3	2.5	
024	10	5.8	4.2	6.4	4.4	6.9	4.7	7.1	4.7	7.3	4.7	7.7	4.7	8.1	4.5
	12	5.8	4.2	6.4	4.4	6.9	4.7	7.1	4.7	7.3	4.7	7.7	4.7	8.1	4.5
	14	5.8	4.2	6.4	4.4	6.9	4.7	7.1	4.7	7.3	4.7	7.7	4.7	8.1	4.5
	16	5.8	4.2	6.4	4.4	6.9	4.7	7.1	4.7	7.3	4.7	7.7	4.7	8.1	4.5
	18	5.8	4.2	6.4	4.4	6.9	4.7	7.1	4.7	7.3	4.7	7.7	4.7	8.1	4.5
	20	5.8	4.2	6.4	4.4	6.9	4.7	7.1	4.7	7.3	4.7	7.7	4.7	8.1	4.5
	21	5.8	4.2	6.4	4.4	6.9	4.7	7.1	4.7	7.3	4.7	7.7	4.7	8.1	4.5
	23	5.8	4.2	6.4	4.4	6.9	4.7	7.1	4.7	7.3	4.7	7.7	4.7	8.1	4.5
	25	5.8	4.2	6.4	4.4	6.9	4.7	7.1	4.7	7.3	4.7	7.7	4.7	8.1	4.5
	27	5.8	4.2	6.4	4.4	6.9	4.7	7.1	4.7	7.3	4.7	7.7	4.7	8.1	4.5
	29	5.8	4.2	6.4	4.4	6.9	4.7	7.1	4.7	7.3	4.7	7.7	4.7	8.1	4.5
	31	5.8	4.2	6.4	4.4	6.9	4.7	7.1	4.7	7.3	4.7	7.7	4.7	8.1	4.5
	33	5.8	4.2	6.4	4.4	6.9	4.7	7.1	4.7	7.3	4.7	7.7	4.7	8.1	4.5
	35	5.8	4.2	6.4	4.4	6.9	4.7	7.1	4.7	7.3	4.7	7.7	4.7	8.1	4.5
	37	5.7	4.0	6.3	4.3	6.7	4.6	6.9	4.6	7.1	4.6	7.5	4.5	7.9	4.4
	39	5.4	3.9	6.0	4.1	6.4	4.4	6.6	4.4	6.8	4.4	7.2	4.3	7.5	4.2
40	5.2	3.8	5.8	4.0	6.2	4.2	6.4	4.2	6.6	4.2	7.0	4.2	7.3	4.1	
42	4.9	3.5	5.4	3.7	5.8	3.9	5.9	3.9	6.1	3.9	6.5	3.9	6.8	3.8	
44	4.4	3.2	4.9	3.4	5.2	3.6	5.4	3.6	5.6	3.6	5.9	3.5	6.2	3.5	
46	3.9	2.8	4.3	3.0	4.6	3.2	4.8	3.2	4.9	3.2	5.2	3.1	5.4	3.1	



Floor Standing Cabinet Type (MML-AP ___ 4H-E)

TC : Total capacity [kW] SHC : Sensible capacity [kW]

unit size	outdoor air temp. °CDB	indoor air temp.													
		14°CWB		16°CWB		18°CWB		19°CWB		20°CWB		22°CWB		24°CWB	
		20°CDB		23°CDB		26°CDB		27°CDB		28°CDB		30°CDB		32°CDB	
		TC	SHC	TC	SHC	TC	SHC	TC	SHC	TC	SHC	TC	SHC	TC	SHC
007	10	1.8	1.6	2.0	1.7	2.1	1.8	2.2	1.8	2.3	1.8	2.4	1.8	2.5	1.7
	12	1.8	1.6	2.0	1.7	2.1	1.8	2.2	1.8	2.3	1.8	2.4	1.8	2.5	1.7
	14	1.8	1.6	2.0	1.7	2.1	1.8	2.2	1.8	2.3	1.8	2.4	1.8	2.5	1.7
	16	1.8	1.6	2.0	1.7	2.1	1.8	2.2	1.8	2.3	1.8	2.4	1.8	2.5	1.7
	18	1.8	1.6	2.0	1.7	2.1	1.8	2.2	1.8	2.3	1.8	2.4	1.8	2.5	1.7
	20	1.8	1.6	2.0	1.7	2.1	1.8	2.2	1.8	2.3	1.8	2.4	1.8	2.5	1.7
	21	1.8	1.6	2.0	1.7	2.1	1.8	2.2	1.8	2.3	1.8	2.4	1.8	2.5	1.7
	23	1.8	1.6	2.0	1.7	2.1	1.8	2.2	1.8	2.3	1.8	2.4	1.8	2.5	1.7
	25	1.8	1.6	2.0	1.7	2.1	1.8	2.2	1.8	2.3	1.8	2.4	1.8	2.5	1.7
	27	1.8	1.6	2.0	1.7	2.1	1.8	2.2	1.8	2.3	1.8	2.4	1.8	2.5	1.7
	29	1.8	1.6	2.0	1.7	2.1	1.8	2.2	1.8	2.3	1.8	2.4	1.8	2.5	1.7
	31	1.8	1.6	2.0	1.7	2.1	1.8	2.2	1.8	2.3	1.8	2.4	1.8	2.5	1.7
	33	1.8	1.6	2.0	1.7	2.1	1.8	2.2	1.8	2.3	1.8	2.4	1.8	2.5	1.7
	35	1.8	1.6	2.0	1.7	2.1	1.8	2.2	1.8	2.3	1.8	2.4	1.8	2.5	1.7
	37	1.8	1.5	1.9	1.6	2.1	1.8	2.1	1.7	2.2	1.7	2.3	1.7	2.4	1.7
	39	1.7	1.5	1.9	1.6	2.0	1.7	2.0	1.7	2.1	1.7	2.2	1.7	2.3	1.6
40	1.6	1.4	1.8	1.5	1.9	1.6	2.0	1.6	2.0	1.6	2.2	1.6	2.3	1.6	
42	1.5	1.3	1.7	1.4	1.8	1.5	1.8	1.5	1.9	1.5	2.0	1.5	2.1	1.5	
44	1.4	1.2	1.5	1.3	1.6	1.4	1.7	1.4	1.7	1.4	1.8	1.4	1.9	1.3	
46	1.2	1.1	1.3	1.1	1.4	1.2	1.5	1.2	1.5	1.2	1.6	1.2	1.7	1.2	
009	10	2.3	1.9	2.5	2.0	2.7	2.1	2.8	2.1	2.9	2.1	3.1	2.1	3.2	2.0
	12	2.3	1.9	2.5	2.0	2.7	2.1	2.8	2.1	2.9	2.1	3.1	2.1	3.2	2.0
	14	2.3	1.9	2.5	2.0	2.7	2.1	2.8	2.1	2.9	2.1	3.1	2.1	3.2	2.0
	16	2.3	1.9	2.5	2.0	2.7	2.1	2.8	2.1	2.9	2.1	3.1	2.1	3.2	2.0
	18	2.3	1.9	2.5	2.0	2.7	2.1	2.8	2.1	2.9	2.1	3.1	2.1	3.2	2.0
	20	2.3	1.9	2.5	2.0	2.7	2.1	2.8	2.1	2.9	2.1	3.1	2.1	3.2	2.0
	21	2.3	1.9	2.5	2.0	2.7	2.1	2.8	2.1	2.9	2.1	3.1	2.1	3.2	2.0
	23	2.3	1.9	2.5	2.0	2.7	2.1	2.8	2.1	2.9	2.1	3.1	2.1	3.2	2.0
	25	2.3	1.9	2.5	2.0	2.7	2.1	2.8	2.1	2.9	2.1	3.1	2.1	3.2	2.0
	27	2.3	1.9	2.5	2.0	2.7	2.1	2.8	2.1	2.9	2.1	3.1	2.1	3.2	2.0
	29	2.3	1.9	2.5	2.0	2.7	2.1	2.8	2.1	2.9	2.1	3.1	2.1	3.2	2.0
	31	2.3	1.9	2.5	2.0	2.7	2.1	2.8	2.1	2.9	2.1	3.1	2.1	3.2	2.0
	33	2.3	1.9	2.5	2.0	2.7	2.1	2.8	2.1	2.9	2.1	3.1	2.1	3.2	2.0
	35	2.3	1.9	2.5	2.0	2.7	2.1	2.8	2.1	2.9	2.1	3.1	2.1	3.2	2.0
	37	2.2	1.8	2.5	1.9	2.6	2.0	2.7	2.0	2.8	2.0	3.0	2.0	3.1	2.0
	39	2.1	1.7	2.4	1.8	2.5	2.0	2.6	1.9	2.7	1.9	2.8	1.9	3.0	1.9
40	2.1	1.7	2.3	1.8	2.4	1.9	2.5	1.9	2.6	1.9	2.7	1.9	2.9	1.8	
42	1.9	1.6	2.1	1.7	2.3	1.8	2.3	1.8	2.4	1.8	2.6	1.7	2.7	1.7	
44	1.8	1.4	1.9	1.5	2.1	1.6	2.1	1.6	2.2	1.6	2.3	1.6	2.4	1.5	
46	1.5	1.3	1.7	1.3	1.8	1.4	1.9	1.4	1.9	1.4	2.1	1.4	2.1	1.4	
012	10	3.0	2.6	3.3	2.7	3.5	2.9	3.6	2.9	3.7	2.9	3.9	2.9	4.1	2.8
	12	3.0	2.6	3.3	2.7	3.5	2.9	3.6	2.9	3.7	2.9	3.9	2.9	4.1	2.8
	14	3.0	2.6	3.3	2.7	3.5	2.9	3.6	2.9	3.7	2.9	3.9	2.9	4.1	2.8
	16	3.0	2.6	3.3	2.7	3.5	2.9	3.6	2.9	3.7	2.9	3.9	2.9	4.1	2.8
	18	3.0	2.6	3.3	2.7	3.5	2.9	3.6	2.9	3.7	2.9	3.9	2.9	4.1	2.8
	20	3.0	2.6	3.3	2.7	3.5	2.9	3.6	2.9	3.7	2.9	3.9	2.9	4.1	2.8
	21	3.0	2.6	3.3	2.7	3.5	2.9	3.6	2.9	3.7	2.9	3.9	2.9	4.1	2.8
	23	3.0	2.6	3.3	2.7	3.5	2.9	3.6	2.9	3.7	2.9	3.9	2.9	4.1	2.8
	25	3.0	2.6	3.3	2.7	3.5	2.9	3.6	2.9	3.7	2.9	3.9	2.9	4.1	2.8
	27	3.0	2.6	3.3	2.7	3.5	2.9	3.6	2.9	3.7	2.9	3.9	2.9	4.1	2.8
	29	3.0	2.6	3.3	2.7	3.5	2.9	3.6	2.9	3.7	2.9	3.9	2.9	4.1	2.8
	31	3.0	2.6	3.3	2.7	3.5	2.9	3.6	2.9	3.7	2.9	3.9	2.9	4.1	2.8
	33	3.0	2.6	3.3	2.7	3.5	2.9	3.6	2.9	3.7	2.9	3.9	2.9	4.1	2.8
	35	3.0	2.6	3.3	2.7	3.5	2.9	3.6	2.9	3.7	2.9	3.9	2.9	4.1	2.8
	37	2.9	2.5	3.2	2.7	3.4	2.8	3.5	2.8	3.6	2.8	3.8	2.8	4.0	2.7
	39	2.7	2.4	3.0	2.5	3.2	2.7	3.3	2.7	3.4	2.7	3.6	2.7	3.8	2.6
40	2.7	2.3	2.9	2.5	3.1	2.6	3.2	2.6	3.3	2.6	3.5	2.6	3.7	2.5	
42	2.5	2.2	2.7	2.3	2.9	2.4	3.0	2.4	3.1	2.4	3.3	2.4	3.4	2.3	
44	2.3	2.0	2.5	2.1	2.7	2.2	2.7	2.2	2.8	2.2	3.0	2.2	3.1	2.1	
46	2.0	1.7	2.2	1.8	2.3	2.0	2.4	2.0	2.5	1.9	2.6	1.9	2.8	1.9	



Floor Standing Cabinet Type (MML-AP ____ 4H-E)

TC : Total capacity [kW] SHC : Sensible capacity [kW]

unit size	outdoor air temp. °CDB	indoor air temp.													
		14°CWB		16°CWB		18°CWB		19°CWB		20°CWB		22°CWB		24°CWB	
		20°CDB	23°CDB	26°CDB	27°CDB	28°CDB	30°CDB	32°CDB	TC	SHC	TC	SHC	TC	SHC	TC
015	10	3.7	3.2	4.1	3.4	4.4	3.6	4.5	3.6	4.6	3.6	4.9	3.6	5.1	3.5
	12	3.7	3.2	4.1	3.4	4.4	3.6	4.5	3.6	4.6	3.6	4.9	3.6	5.1	3.5
	14	3.7	3.2	4.1	3.4	4.4	3.6	4.5	3.6	4.6	3.6	4.9	3.6	5.1	3.5
	16	3.7	3.2	4.1	3.4	4.4	3.6	4.5	3.6	4.6	3.6	4.9	3.6	5.1	3.5
	18	3.7	3.2	4.1	3.4	4.4	3.6	4.5	3.6	4.6	3.6	4.9	3.6	5.1	3.5
	20	3.7	3.2	4.1	3.4	4.4	3.6	4.5	3.6	4.6	3.6	4.9	3.6	5.1	3.5
	21	3.7	3.2	4.1	3.4	4.4	3.6	4.5	3.6	4.6	3.6	4.9	3.6	5.1	3.5
	23	3.7	3.2	4.1	3.4	4.4	3.6	4.5	3.6	4.6	3.6	4.9	3.6	5.1	3.5
	25	3.7	3.2	4.1	3.4	4.4	3.6	4.5	3.6	4.6	3.6	4.9	3.6	5.1	3.5
	27	3.7	3.2	4.1	3.4	4.4	3.6	4.5	3.6	4.6	3.6	4.9	3.6	5.1	3.5
	29	3.7	3.2	4.1	3.4	4.4	3.6	4.5	3.6	4.6	3.6	4.9	3.6	5.1	3.5
	31	3.7	3.2	4.1	3.4	4.4	3.6	4.5	3.6	4.6	3.6	4.9	3.6	5.1	3.5
	33	3.7	3.2	4.1	3.4	4.4	3.6	4.5	3.6	4.6	3.6	4.9	3.6	5.1	3.5
	35	3.7	3.2	4.1	3.4	4.4	3.6	4.5	3.6	4.6	3.6	4.9	3.6	5.1	3.5
	37	3.6	3.1	4.0	3.3	4.2	3.5	4.4	3.5	4.5	3.5	4.8	3.5	5.0	3.4
	39	3.4	3.0	3.8	3.2	4.0	3.3	4.2	3.3	4.3	3.3	4.5	3.3	4.8	3.2
	40	3.3	2.9	3.7	3.1	3.9	3.2	4.1	3.2	4.2	3.2	4.4	3.2	4.6	3.1
42	3.1	2.7	3.4	2.8	3.7	3.0	3.8	3.0	3.9	3.0	4.1	3.0	4.3	2.9	
44	2.8	2.4	3.1	2.6	3.3	2.7	3.4	2.7	3.5	2.7	3.7	2.7	3.9	2.7	
46	2.5	2.1	2.7	2.3	2.9	2.4	3.0	2.4	3.1	2.4	3.3	2.4	3.4	2.3	
018	10	4.6	3.8	5.1	4.1	5.4	4.3	5.6	4.3	5.8	4.3	6.1	4.3	6.4	4.2
	12	4.6	3.8	5.1	4.1	5.4	4.3	5.6	4.3	5.8	4.3	6.1	4.3	6.4	4.2
	14	4.6	3.8	5.1	4.1	5.4	4.3	5.6	4.3	5.8	4.3	6.1	4.3	6.4	4.2
	16	4.6	3.8	5.1	4.1	5.4	4.3	5.6	4.3	5.8	4.3	6.1	4.3	6.4	4.2
	18	4.6	3.8	5.1	4.1	5.4	4.3	5.6	4.3	5.8	4.3	6.1	4.3	6.4	4.2
	20	4.6	3.8	5.1	4.1	5.4	4.3	5.6	4.3	5.8	4.3	6.1	4.3	6.4	4.2
	21	4.6	3.8	5.1	4.1	5.4	4.3	5.6	4.3	5.8	4.3	6.1	4.3	6.4	4.2
	23	4.6	3.8	5.1	4.1	5.4	4.3	5.6	4.3	5.8	4.3	6.1	4.3	6.4	4.2
	25	4.6	3.8	5.1	4.1	5.4	4.3	5.6	4.3	5.8	4.3	6.1	4.3	6.4	4.2
	27	4.6	3.8	5.1	4.1	5.4	4.3	5.6	4.3	5.8	4.3	6.1	4.3	6.4	4.2
	29	4.6	3.8	5.1	4.1	5.4	4.3	5.6	4.3	5.8	4.3	6.1	4.3	6.4	4.2
	31	4.6	3.8	5.1	4.1	5.4	4.3	5.6	4.3	5.8	4.3	6.1	4.3	6.4	4.2
	33	4.6	3.8	5.1	4.1	5.4	4.3	5.6	4.3	5.8	4.3	6.1	4.3	6.4	4.2
	35	4.6	3.8	5.1	4.1	5.4	4.3	5.6	4.3	5.8	4.3	6.1	4.3	6.4	4.2
	37	4.5	3.7	4.9	3.9	5.3	4.2	5.4	4.2	5.6	4.2	5.9	4.1	6.2	4.0
	39	4.3	3.5	4.7	3.8	5.0	4.0	5.2	4.0	5.3	4.0	5.7	3.9	5.9	3.9
	40	4.1	3.4	4.6	3.7	4.9	3.9	5.0	3.9	5.2	3.9	5.5	3.8	5.7	3.7
42	3.8	3.2	4.3	3.4	4.5	3.6	4.7	3.6	4.8	3.6	5.1	3.6	5.3	3.5	
44	3.5	2.9	3.9	3.1	4.1	3.3	4.3	3.3	4.4	3.3	4.6	3.2	4.9	3.2	
46	3.1	2.6	3.4	2.7	3.7	2.9	3.8	2.9	3.9	2.9	4.1	2.9	4.3	2.8	
024	10	5.8	4.6	6.4	4.9	6.9	5.2	7.1	5.2	7.3	5.2	7.7	5.2	8.1	5.0
	12	5.8	4.6	6.4	4.9	6.9	5.2	7.1	5.2	7.3	5.2	7.7	5.2	8.1	5.0
	14	5.8	4.6	6.4	4.9	6.9	5.2	7.1	5.2	7.3	5.2	7.7	5.2	8.1	5.0
	16	5.8	4.6	6.4	4.9	6.9	5.2	7.1	5.2	7.3	5.2	7.7	5.2	8.1	5.0
	18	5.8	4.6	6.4	4.9	6.9	5.2	7.1	5.2	7.3	5.2	7.7	5.2	8.1	5.0
	20	5.8	4.6	6.4	4.9	6.9	5.2	7.1	5.2	7.3	5.2	7.7	5.2	8.1	5.0
	21	5.8	4.6	6.4	4.9	6.9	5.2	7.1	5.2	7.3	5.2	7.7	5.2	8.1	5.0
	23	5.8	4.6	6.4	4.9	6.9	5.2	7.1	5.2	7.3	5.2	7.7	5.2	8.1	5.0
	25	5.8	4.6	6.4	4.9	6.9	5.2	7.1	5.2	7.3	5.2	7.7	5.2	8.1	5.0
	27	5.8	4.6	6.4	4.9	6.9	5.2	7.1	5.2	7.3	5.2	7.7	5.2	8.1	5.0
	29	5.8	4.6	6.4	4.9	6.9	5.2	7.1	5.2	7.3	5.2	7.7	5.2	8.1	5.0
	31	5.8	4.6	6.4	4.9	6.9	5.2	7.1	5.2	7.3	5.2	7.7	5.2	8.1	5.0
	33	5.8	4.6	6.4	4.9	6.9	5.2	7.1	5.2	7.3	5.2	7.7	5.2	8.1	5.0
	35	5.8	4.6	6.4	4.9	6.9	5.2	7.1	5.2	7.3	5.2	7.7	5.2	8.1	5.0
	37	5.7	4.5	6.3	4.8	6.7	5.1	6.9	5.0	7.1	5.0	7.5	5.0	7.9	4.9
	39	5.4	4.3	6.0	4.6	6.4	4.8	6.6	4.8	6.8	4.8	7.2	4.8	7.5	4.7
	40	5.2	4.2	5.8	4.4	6.2	4.7	6.4	4.7	6.6	4.7	7.0	4.6	7.3	4.5
42	4.9	3.9	5.4	4.1	5.8	4.4	5.9	4.4	6.1	4.4	6.5	4.3	6.8	4.2	
44	4.4	3.5	4.9	3.7	5.2	4.0	5.4	4.0	5.6	4.0	5.9	3.9	6.2	3.8	
46	3.9	3.1	4.3	3.3	4.6	3.5	4.8	3.5	4.9	3.5	5.2	3.5	5.4	3.4	



Floor standing Type (MMF-AP___6H-E)

TC : Total capacity [kW] SHC : Sensible capacity [kW]

unit size	outdoor air temp. °CDB	Indoor air temp.													
		14°CWB		16°CWB		18°CWB		19°CWB		20°CWB		22°CWB		24°CWB	
		20°CDB	23°CDB	26°CDB	27°CDB	28°CDB	30°CDB	32°CDB	TC	SHC	TC	SHC	TC	SHC	TC
015	10	3.7	3.1	4.1	3.3	4.4	3.5	4.5	3.5	4.6	3.5	4.9	3.5	5.1	3.4
	12	3.7	3.1	4.1	3.3	4.4	3.5	4.5	3.5	4.6	3.5	4.9	3.5	5.1	3.4
	14	3.7	3.1	4.1	3.3	4.4	3.5	4.5	3.5	4.6	3.5	4.9	3.5	5.1	3.4
	16	3.7	3.1	4.1	3.3	4.4	3.5	4.5	3.5	4.6	3.5	4.9	3.5	5.1	3.4
	18	3.7	3.1	4.1	3.3	4.4	3.5	4.5	3.5	4.6	3.5	4.9	3.5	5.1	3.4
	20	3.7	3.1	4.1	3.3	4.4	3.5	4.5	3.5	4.6	3.5	4.9	3.5	5.1	3.4
	21	3.7	3.1	4.1	3.3	4.4	3.5	4.5	3.5	4.6	3.5	4.9	3.5	5.1	3.4
	23	3.7	3.1	4.1	3.3	4.4	3.5	4.5	3.5	4.6	3.5	4.9	3.5	5.1	3.4
	25	3.7	3.1	4.1	3.3	4.4	3.5	4.5	3.5	4.6	3.5	4.9	3.5	5.1	3.4
	27	3.7	3.1	4.1	3.3	4.4	3.5	4.5	3.5	4.6	3.5	4.9	3.5	5.1	3.4
	29	3.7	3.1	4.1	3.3	4.4	3.5	4.5	3.5	4.6	3.5	4.9	3.5	5.1	3.4
	31	3.7	3.1	4.1	3.3	4.4	3.5	4.5	3.5	4.6	3.5	4.9	3.5	5.1	3.4
	33	3.7	3.1	4.1	3.3	4.4	3.5	4.5	3.5	4.6	3.5	4.9	3.5	5.1	3.4
	35	3.7	3.1	4.1	3.3	4.4	3.5	4.5	3.5	4.6	3.5	4.9	3.5	5.1	3.4
	37	3.6	3.0	4.0	3.2	4.2	3.4	4.4	3.4	4.5	3.4	4.8	3.4	5.0	3.3
	39	3.4	2.9	3.8	3.1	4.0	3.3	4.2	3.2	4.3	3.2	4.5	3.2	4.8	3.1
40	3.3	2.8	3.7	3.0	3.9	3.2	4.1	3.2	4.2	3.2	4.4	3.1	4.6	3.0	
42	3.1	2.6	3.4	2.8	3.7	2.9	3.8	2.9	3.9	2.9	4.1	2.9	4.3	2.8	
44	2.8	2.4	3.1	2.5	3.3	2.7	3.4	2.7	3.5	2.7	3.7	2.6	3.9	2.6	
46	2.5	2.1	2.7	2.2	2.9	2.4	3.0	2.4	3.1	2.4	3.3	2.3	3.4	2.3	
018	10	4.6	3.6	5.1	3.9	5.4	4.1	5.6	4.1	5.8	4.1	6.1	4.1	6.4	4.0
	12	4.6	3.6	5.1	3.9	5.4	4.1	5.6	4.1	5.8	4.1	6.1	4.1	6.4	4.0
	14	4.6	3.6	5.1	3.9	5.4	4.1	5.6	4.1	5.8	4.1	6.1	4.1	6.4	4.0
	16	4.6	3.6	5.1	3.9	5.4	4.1	5.6	4.1	5.8	4.1	6.1	4.1	6.4	4.0
	18	4.6	3.6	5.1	3.9	5.4	4.1	5.6	4.1	5.8	4.1	6.1	4.1	6.4	4.0
	20	4.6	3.6	5.1	3.9	5.4	4.1	5.6	4.1	5.8	4.1	6.1	4.1	6.4	4.0
	21	4.6	3.6	5.1	3.9	5.4	4.1	5.6	4.1	5.8	4.1	6.1	4.1	6.4	4.0
	23	4.6	3.6	5.1	3.9	5.4	4.1	5.6	4.1	5.8	4.1	6.1	4.1	6.4	4.0
	25	4.6	3.6	5.1	3.9	5.4	4.1	5.6	4.1	5.8	4.1	6.1	4.1	6.4	4.0
	27	4.6	3.6	5.1	3.9	5.4	4.1	5.6	4.1	5.8	4.1	6.1	4.1	6.4	4.0
	29	4.6	3.6	5.1	3.9	5.4	4.1	5.6	4.1	5.8	4.1	6.1	4.1	6.4	4.0
	31	4.6	3.6	5.1	3.9	5.4	4.1	5.6	4.1	5.8	4.1	6.1	4.1	6.4	4.0
	33	4.6	3.6	5.1	3.9	5.4	4.1	5.6	4.1	5.8	4.1	6.1	4.1	6.4	4.0
	35	4.6	3.6	5.1	3.9	5.4	4.1	5.6	4.1	5.8	4.1	6.1	4.1	6.4	4.0
	37	4.5	3.5	4.9	3.8	5.3	4.0	5.4	4.0	5.6	4.0	5.9	3.9	6.2	3.8
	39	4.3	3.4	4.7	3.6	5.0	3.8	5.2	3.8	5.3	3.8	5.7	3.8	5.9	3.7
40	4.1	3.3	4.6	3.5	4.9	3.7	5.0	3.7	5.2	3.7	5.5	3.7	5.7	3.6	
42	3.8	3.0	4.3	3.2	4.5	3.4	4.7	3.4	4.8	3.4	5.1	3.4	5.3	3.3	
44	3.5	2.8	3.9	2.9	4.1	3.1	4.3	3.1	4.4	3.1	4.6	3.1	4.9	3.0	
46	3.1	2.4	3.4	2.6	3.7	2.8	3.8	2.8	3.9	2.8	4.1	2.7	4.3	2.7	
024	10	5.8	4.9	6.4	5.2	6.9	5.5	7.1	5.5	7.3	5.5	7.7	5.4	8.1	5.3
	12	5.8	4.9	6.4	5.2	6.9	5.5	7.1	5.5	7.3	5.5	7.7	5.4	8.1	5.3
	14	5.8	4.9	6.4	5.2	6.9	5.5	7.1	5.5	7.3	5.5	7.7	5.4	8.1	5.3
	16	5.8	4.9	6.4	5.2	6.9	5.5	7.1	5.5	7.3	5.5	7.7	5.4	8.1	5.3
	18	5.8	4.9	6.4	5.2	6.9	5.5	7.1	5.5	7.3	5.5	7.7	5.4	8.1	5.3
	20	5.8	4.9	6.4	5.2	6.9	5.5	7.1	5.5	7.3	5.5	7.7	5.4	8.1	5.3
	21	5.8	4.9	6.4	5.2	6.9	5.5	7.1	5.5	7.3	5.5	7.7	5.4	8.1	5.3
	23	5.8	4.9	6.4	5.2	6.9	5.5	7.1	5.5	7.3	5.5	7.7	5.4	8.1	5.3
	25	5.8	4.9	6.4	5.2	6.9	5.5	7.1	5.5	7.3	5.5	7.7	5.4	8.1	5.3
	27	5.8	4.9	6.4	5.2	6.9	5.5	7.1	5.5	7.3	5.5	7.7	5.4	8.1	5.3
	29	5.8	4.9	6.4	5.2	6.9	5.5	7.1	5.5	7.3	5.5	7.7	5.4	8.1	5.3
	31	5.8	4.9	6.4	5.2	6.9	5.5	7.1	5.5	7.3	5.5	7.7	5.4	8.1	5.3
	33	5.8	4.9	6.4	5.2	6.9	5.5	7.1	5.5	7.3	5.5	7.7	5.4	8.1	5.3
	35	5.8	4.9	6.4	5.2	6.9	5.5	7.1	5.5	7.3	5.5	7.7	5.4	8.1	5.3
	37	5.7	4.7	6.3	5.0	6.7	5.4	6.9	5.3	7.1	5.3	7.5	5.3	7.9	5.2
	39	5.4	4.5	6.0	4.8	6.4	5.1	6.6	5.1	6.8	5.1	7.2	5.0	7.5	4.9
40	5.2	4.4	5.8	4.7	6.2	5.0	6.4	5.0	6.6	5.0	7.0	4.9	7.3	4.8	
42	4.9	4.1	5.4	4.3	5.8	4.6	5.9	4.6	6.1	4.6	6.5	4.6	6.8	4.5	
44	4.4	3.7	4.9	4.0	5.2	4.2	5.4	4.2	5.6	4.2	5.9	4.1	6.2	4.1	
46	3.9	3.3	4.3	3.5	4.6	3.7	4.8	3.7	4.9	3.7	5.2	3.7	5.4	3.6	



Floor standing Type (MMF-AP ___ 6H-E)

TC : Total capacity [kW] SHC : Sensible capacity [kW]

unit size	outdoor air temp. °CDB	indoor air temp.													
		14°CWB		16°CWB		18°CWB		19°CWB		20°CWB		22°CWB		24°CWB	
		20°CDB	23°CDB	26°CDB	27°CDB	28°CDB	30°CDB	32°CDB	TC	SHC	TC	SHC	TC	SHC	TC
027	10	6.6	5.2	7.3	5.6	7.8	5.9	8.0	5.9	8.2	5.9	8.7	5.8	9.1	5.7
	12	6.6	5.2	7.3	5.6	7.8	5.9	8.0	5.9	8.2	5.9	8.7	5.8	9.1	5.7
	14	6.6	5.2	7.3	5.6	7.8	5.9	8.0	5.9	8.2	5.9	8.7	5.8	9.1	5.7
	16	6.6	5.2	7.3	5.6	7.8	5.9	8.0	5.9	8.2	5.9	8.7	5.8	9.1	5.7
	18	6.6	5.2	7.3	5.6	7.8	5.9	8.0	5.9	8.2	5.9	8.7	5.8	9.1	5.7
	20	6.6	5.2	7.3	5.6	7.8	5.9	8.0	5.9	8.2	5.9	8.7	5.8	9.1	5.7
	21	6.6	5.2	7.3	5.6	7.8	5.9	8.0	5.9	8.2	5.9	8.7	5.8	9.1	5.7
	23	6.6	5.2	7.3	5.6	7.8	5.9	8.0	5.9	8.2	5.9	8.7	5.8	9.1	5.7
	25	6.6	5.2	7.3	5.6	7.8	5.9	8.0	5.9	8.2	5.9	8.7	5.8	9.1	5.7
	27	6.6	5.2	7.3	5.6	7.8	5.9	8.0	5.9	8.2	5.9	8.7	5.8	9.1	5.7
	29	6.6	5.2	7.3	5.6	7.8	5.9	8.0	5.9	8.2	5.9	8.7	5.8	9.1	5.7
	31	6.6	5.2	7.3	5.6	7.8	5.9	8.0	5.9	8.2	5.9	8.7	5.8	9.1	5.7
	33	6.6	5.2	7.3	5.6	7.8	5.9	8.0	5.9	8.2	5.9	8.7	5.8	9.1	5.7
	35	6.6	5.2	7.3	5.6	7.8	5.9	8.0	5.9	8.2	5.9	8.7	5.8	9.1	5.7
	37	6.4	5.1	7.0	5.4	7.5	5.7	7.8	5.7	8.0	5.7	8.5	5.7	8.8	5.5
	39	6.1	4.8	6.7	5.2	7.2	5.5	7.4	5.5	7.6	5.5	8.1	5.4	8.5	5.3
40	5.9	4.7	6.5	5.0	7.0	5.3	7.2	5.3	7.4	5.3	7.8	5.3	8.2	5.1	
42	5.5	4.4	6.1	4.7	6.5	5.0	6.7	4.9	6.9	4.9	7.3	4.9	7.6	4.8	
44	5.0	4.0	5.5	4.2	5.9	4.5	6.1	4.5	6.3	4.5	6.6	4.5	6.9	4.3	
46	4.4	3.5	4.9	3.7	5.2	4.0	5.4	4.0	5.5	4.0	5.9	3.9	6.1	3.8	
036	10	9.2	7.5	10.2	8.0	10.9	8.5	11.2	8.5	11.5	8.5	12.2	8.4	12.8	8.2
	12	9.2	7.5	10.2	8.0	10.9	8.5	11.2	8.5	11.5	8.5	12.2	8.4	12.8	8.2
	14	9.2	7.5	10.2	8.0	10.9	8.5	11.2	8.5	11.5	8.5	12.2	8.4	12.8	8.2
	16	9.2	7.5	10.2	8.0	10.9	8.5	11.2	8.5	11.5	8.5	12.2	8.4	12.8	8.2
	18	9.2	7.5	10.2	8.0	10.9	8.5	11.2	8.5	11.5	8.5	12.2	8.4	12.8	8.2
	20	9.2	7.5	10.2	8.0	10.9	8.5	11.2	8.5	11.5	8.5	12.2	8.4	12.8	8.2
	21	9.2	7.5	10.2	8.0	10.9	8.5	11.2	8.5	11.5	8.5	12.2	8.4	12.8	8.2
	23	9.2	7.5	10.2	8.0	10.9	8.5	11.2	8.5	11.5	8.5	12.2	8.4	12.8	8.2
	25	9.2	7.5	10.2	8.0	10.9	8.5	11.2	8.5	11.5	8.5	12.2	8.4	12.8	8.2
	27	9.2	7.5	10.2	8.0	10.9	8.5	11.2	8.5	11.5	8.5	12.2	8.4	12.8	8.2
	29	9.2	7.5	10.2	8.0	10.9	8.5	11.2	8.5	11.5	8.5	12.2	8.4	12.8	8.2
	31	9.2	7.5	10.2	8.0	10.9	8.5	11.2	8.5	11.5	8.5	12.2	8.4	12.8	8.2
	33	9.2	7.5	10.2	8.0	10.9	8.5	11.2	8.5	11.5	8.5	12.2	8.4	12.8	8.2
	35	9.2	7.5	10.2	8.0	10.9	8.5	11.2	8.5	11.5	8.5	12.2	8.4	12.8	8.2
	37	8.9	7.3	9.9	7.8	10.5	8.3	10.9	8.2	11.2	8.2	11.8	8.2	12.4	8.0
	39	8.5	7.0	9.4	7.4	10.1	7.9	10.4	7.9	10.7	7.9	11.3	7.8	11.8	7.6
40	8.3	6.8	9.2	7.2	9.8	7.7	10.1	7.7	10.4	7.7	11.0	7.6	11.5	7.4	
42	7.7	6.3	8.5	6.7	9.1	7.1	9.4	7.1	9.7	7.1	10.2	7.1	10.7	6.9	
44	7.0	5.7	7.7	6.1	8.3	6.5	8.5	6.5	8.8	6.5	9.3	6.4	9.7	6.3	
46	6.2	5.1	6.8	5.4	7.3	5.7	7.5	5.7	7.8	5.7	8.2	5.7	8.6	5.5	
048	10	11.5	9.0	12.7	9.6	13.6	10.2	14.0	10.2	14.4	10.2	15.3	10.1	16.0	9.9
	12	11.5	9.0	12.7	9.6	13.6	10.2	14.0	10.2	14.4	10.2	15.3	10.1	16.0	9.9
	14	11.5	9.0	12.7	9.6	13.6	10.2	14.0	10.2	14.4	10.2	15.3	10.1	16.0	9.9
	16	11.5	9.0	12.7	9.6	13.6	10.2	14.0	10.2	14.4	10.2	15.3	10.1	16.0	9.9
	18	11.5	9.0	12.7	9.6	13.6	10.2	14.0	10.2	14.4	10.2	15.3	10.1	16.0	9.9
	20	11.5	9.0	12.7	9.6	13.6	10.2	14.0	10.2	14.4	10.2	15.3	10.1	16.0	9.9
	21	11.5	9.0	12.7	9.6	13.6	10.2	14.0	10.2	14.4	10.2	15.3	10.1	16.0	9.9
	23	11.5	9.0	12.7	9.6	13.6	10.2	14.0	10.2	14.4	10.2	15.3	10.1	16.0	9.9
	25	11.5	9.0	12.7	9.6	13.6	10.2	14.0	10.2	14.4	10.2	15.3	10.1	16.0	9.9
	27	11.5	9.0	12.7	9.6	13.6	10.2	14.0	10.2	14.4	10.2	15.3	10.1	16.0	9.9
	29	11.5	9.0	12.7	9.6	13.6	10.2	14.0	10.2	14.4	10.2	15.3	10.1	16.0	9.9
	31	11.5	9.0	12.7	9.6	13.6	10.2	14.0	10.2	14.4	10.2	15.3	10.1	16.0	9.9
	33	11.5	9.0	12.7	9.6	13.6	10.2	14.0	10.2	14.4	10.2	15.3	10.1	16.0	9.9
	35	11.5	9.0	12.7	9.6	13.6	10.2	14.0	10.2	14.4	10.2	15.3	10.1	16.0	9.9
	37	11.1	8.8	12.3	9.3	13.2	9.9	13.6	9.9	14.0	9.9	14.8	9.8	15.5	9.6
	39	10.7	8.4	11.8	8.9	12.6	9.5	13.0	9.5	13.4	9.5	14.1	9.4	14.8	9.1
40	10.3	8.1	11.4	8.7	12.2	9.2	12.6	9.2	13.0	9.2	13.7	9.1	14.4	8.9	
42	9.6	7.6	10.6	8.1	11.4	8.6	11.7	8.5	12.1	8.5	12.8	8.5	13.4	8.3	
44	8.8	6.9	9.7	7.3	10.3	7.8	10.7	7.8	11.0	7.8	11.6	7.7	12.2	7.5	
46	7.7	6.1	8.5	6.5	9.1	6.9	9.4	6.9	9.7	6.9	10.3	6.8	10.7	6.6	



Sensible capacity table



Floor standing Type (MMF-AP ___ 6H-E)

TC : Total capacity [kW] SHC : Sensible capacity [kW]

unit size	outdoor air temp. °CDB	indoor air temp.													
		14°CWB		16°CWB		18°CWB		19°CWB		20°CWB		22°CWB		24°CWB	
		20°CDB		23°CDB		26°CDB		27°CDB		28°CDB		30°CDB		32°CDB	
		TC	SHC	TC	SHC	TC	SHC	TC	SHC	TC	SHC	TC	SHC	TC	SHC
056	10	13.1	10.1	14.5	10.8	15.5	11.4	16.0	11.4	16.5	11.4	17.4	11.3	18.2	11.0
	12	13.1	10.1	14.5	10.8	15.5	11.4	16.0	11.4	16.5	11.4	17.4	11.3	18.2	11.0
	14	13.1	10.1	14.5	10.8	15.5	11.4	16.0	11.4	16.5	11.4	17.4	11.3	18.2	11.0
	16	13.1	10.1	14.5	10.8	15.5	11.4	16.0	11.4	16.5	11.4	17.4	11.3	18.2	11.0
	18	13.1	10.1	14.5	10.8	15.5	11.4	16.0	11.4	16.5	11.4	17.4	11.3	18.2	11.0
	20	13.1	10.1	14.5	10.8	15.5	11.4	16.0	11.4	16.5	11.4	17.4	11.3	18.2	11.0
	21	13.1	10.1	14.5	10.8	15.5	11.4	16.0	11.4	16.5	11.4	17.4	11.3	18.2	11.0
	23	13.1	10.1	14.5	10.8	15.5	11.4	16.0	11.4	16.5	11.4	17.4	11.3	18.2	11.0
	25	13.1	10.1	14.5	10.8	15.5	11.4	16.0	11.4	16.5	11.4	17.4	11.3	18.2	11.0
	27	13.1	10.1	14.5	10.8	15.5	11.4	16.0	11.4	16.5	11.4	17.4	11.3	18.2	11.0
	29	13.1	10.1	14.5	10.8	15.5	11.4	16.0	11.4	16.5	11.4	17.4	11.3	18.2	11.0
	31	13.1	10.1	14.5	10.8	15.5	11.4	16.0	11.4	16.5	11.4	17.4	11.3	18.2	11.0
	33	13.1	10.1	14.5	10.8	15.5	11.4	16.0	11.4	16.5	11.4	17.4	11.3	18.2	11.0
	35	13.1	10.1	14.5	10.8	15.5	11.4	16.0	11.4	16.5	11.4	17.4	11.3	18.2	11.0
	37	12.7	9.8	14.1	10.4	15.1	11.1	15.5	11.1	16.0	11.1	16.9	11.0	17.7	10.7
	39	12.2	9.4	13.5	10.0	14.4	10.6	14.8	10.6	15.3	10.6	16.2	10.5	16.9	10.2
	40	11.8	9.1	13.1	9.7	14.0	10.3	14.4	10.3	14.8	10.3	15.7	10.2	16.4	9.9
	42	11.0	8.5	12.2	9.0	13.0	9.6	13.4	9.5	13.8	9.5	14.6	9.5	15.3	9.2
44	10.0	7.7	11.1	8.2	11.8	8.7	12.2	8.7	12.5	8.7	13.3	8.6	13.9	8.4	
46	8.8	6.8	9.8	7.2	10.4	7.7	10.8	7.7	11.1	7.7	11.7	7.6	12.3	7.4	



Console Type (MML-AP__4NH-E)

TC : Total capacity [kW] SHC : Sensible capacity [kW]

unit size	outdoor air temp. °CDB	indoor air temp.													
		14°CWB		16°CWB		18°CWB		19°CWB		20°CWB		22°CWB		24°CWB	
		20°CDB		23°CDB		26°CDB		27°CDB		28°CDB		30°CDB		32°CDB	
		TC	SHC	TC	SHC	TC	SHC	TC	SHC	TC	SHC	TC	SHC	TC	SHC
007	10	1.8	1.6	2.0	1.7	2.1	1.8	2.2	1.8	2.3	1.8	2.4	1.8	2.5	1.7
	12	1.8	1.6	2.0	1.7	2.1	1.8	2.2	1.8	2.3	1.8	2.4	1.8	2.5	1.7
	14	1.8	1.6	2.0	1.7	2.1	1.8	2.2	1.8	2.3	1.8	2.4	1.8	2.5	1.7
	16	1.8	1.6	2.0	1.7	2.1	1.8	2.2	1.8	2.3	1.8	2.4	1.8	2.5	1.7
	18	1.8	1.6	2.0	1.7	2.1	1.8	2.2	1.8	2.3	1.8	2.4	1.8	2.5	1.7
	20	1.8	1.6	2.0	1.7	2.1	1.8	2.2	1.8	2.3	1.8	2.4	1.8	2.5	1.7
	21	1.8	1.6	2.0	1.7	2.1	1.8	2.2	1.8	2.3	1.8	2.4	1.8	2.5	1.7
	23	1.8	1.6	2.0	1.7	2.1	1.8	2.2	1.8	2.3	1.8	2.4	1.8	2.5	1.7
	25	1.8	1.6	2.0	1.7	2.1	1.8	2.2	1.8	2.3	1.8	2.4	1.8	2.5	1.7
	27	1.8	1.6	2.0	1.7	2.1	1.8	2.2	1.8	2.3	1.8	2.4	1.8	2.5	1.7
	29	1.8	1.6	2.0	1.7	2.1	1.8	2.2	1.8	2.3	1.8	2.4	1.8	2.5	1.7
	31	1.8	1.6	2.0	1.7	2.1	1.8	2.2	1.8	2.3	1.8	2.4	1.8	2.5	1.7
	33	1.8	1.6	2.0	1.7	2.1	1.8	2.2	1.8	2.3	1.8	2.4	1.8	2.5	1.7
	35	1.8	1.6	2.0	1.7	2.1	1.8	2.2	1.8	2.3	1.8	2.4	1.8	2.5	1.7
	37	1.8	1.5	1.9	1.6	2.1	1.8	2.1	1.7	2.2	1.7	2.3	1.7	2.4	1.7
	39	1.7	1.5	1.9	1.6	2.0	1.7	2.0	1.7	2.1	1.7	2.2	1.7	2.3	1.6
40	1.6	1.4	1.8	1.5	1.9	1.6	2.0	1.6	2.0	1.6	2.2	1.6	2.3	1.6	
42	1.5	1.3	1.7	1.4	1.8	1.5	1.8	1.5	1.9	1.5	2.0	1.5	2.1	1.5	
44	1.4	1.2	1.5	1.3	1.6	1.4	1.7	1.4	1.7	1.4	1.8	1.4	1.9	1.3	
46	1.2	1.1	1.3	1.1	1.4	1.2	1.5	1.2	1.5	1.2	1.6	1.2	1.7	1.2	
009	10	2.3	1.9	2.5	2.0	2.7	2.1	2.8	2.1	2.9	2.1	3.1	2.1	3.2	2.0
	12	2.3	1.9	2.5	2.0	2.7	2.1	2.8	2.1	2.9	2.1	3.1	2.1	3.2	2.0
	14	2.3	1.9	2.5	2.0	2.7	2.1	2.8	2.1	2.9	2.1	3.1	2.1	3.2	2.0
	16	2.3	1.9	2.5	2.0	2.7	2.1	2.8	2.1	2.9	2.1	3.1	2.1	3.2	2.0
	18	2.3	1.9	2.5	2.0	2.7	2.1	2.8	2.1	2.9	2.1	3.1	2.1	3.2	2.0
	20	2.3	1.9	2.5	2.0	2.7	2.1	2.8	2.1	2.9	2.1	3.1	2.1	3.2	2.0
	21	2.3	1.9	2.5	2.0	2.7	2.1	2.8	2.1	2.9	2.1	3.1	2.1	3.2	2.0
	23	2.3	1.9	2.5	2.0	2.7	2.1	2.8	2.1	2.9	2.1	3.1	2.1	3.2	2.0
	25	2.3	1.9	2.5	2.0	2.7	2.1	2.8	2.1	2.9	2.1	3.1	2.1	3.2	2.0
	27	2.3	1.9	2.5	2.0	2.7	2.1	2.8	2.1	2.9	2.1	3.1	2.1	3.2	2.0
	29	2.3	1.9	2.5	2.0	2.7	2.1	2.8	2.1	2.9	2.1	3.1	2.1	3.2	2.0
	31	2.3	1.9	2.5	2.0	2.7	2.1	2.8	2.1	2.9	2.1	3.1	2.1	3.2	2.0
	33	2.3	1.9	2.5	2.0	2.7	2.1	2.8	2.1	2.9	2.1	3.1	2.1	3.2	2.0
	35	2.3	1.9	2.5	2.0	2.7	2.1	2.8	2.1	2.9	2.1	3.1	2.1	3.2	2.0
	37	2.2	1.8	2.5	1.9	2.6	2.0	2.7	2.0	2.8	2.0	3.0	2.0	3.1	2.0
	39	2.1	1.7	2.4	1.8	2.5	2.0	2.6	1.9	2.7	1.9	2.8	1.9	3.0	1.9
40	2.1	1.7	2.3	1.8	2.4	1.9	2.5	1.9	2.6	1.9	2.7	1.9	2.9	1.8	
42	1.9	1.6	2.1	1.7	2.3	1.8	2.3	1.8	2.4	1.8	2.6	1.7	2.7	1.7	
44	1.8	1.4	1.9	1.5	2.1	1.6	2.1	1.6	2.2	1.6	2.3	1.6	2.4	1.5	
46	1.5	1.3	1.7	1.3	1.8	1.4	1.9	1.4	1.9	1.4	2.1	1.4	2.1	1.4	
012	10	3.0	2.3	3.3	2.5	3.5	2.6	3.6	2.6	3.7	2.6	3.9	2.6	4.1	2.5
	12	3.0	2.3	3.3	2.5	3.5	2.6	3.6	2.6	3.7	2.6	3.9	2.6	4.1	2.5
	14	3.0	2.3	3.3	2.5	3.5	2.6	3.6	2.6	3.7	2.6	3.9	2.6	4.1	2.5
	16	3.0	2.3	3.3	2.5	3.5	2.6	3.6	2.6	3.7	2.6	3.9	2.6	4.1	2.5
	18	3.0	2.3	3.3	2.5	3.5	2.6	3.6	2.6	3.7	2.6	3.9	2.6	4.1	2.5
	20	3.0	2.3	3.3	2.5	3.5	2.6	3.6	2.6	3.7	2.6	3.9	2.6	4.1	2.5
	21	3.0	2.3	3.3	2.5	3.5	2.6	3.6	2.6	3.7	2.6	3.9	2.6	4.1	2.5
	23	3.0	2.3	3.3	2.5	3.5	2.6	3.6	2.6	3.7	2.6	3.9	2.6	4.1	2.5
	25	3.0	2.3	3.3	2.5	3.5	2.6	3.6	2.6	3.7	2.6	3.9	2.6	4.1	2.5
	27	3.0	2.3	3.3	2.5	3.5	2.6	3.6	2.6	3.7	2.6	3.9	2.6	4.1	2.5
	29	3.0	2.3	3.3	2.5	3.5	2.6	3.6	2.6	3.7	2.6	3.9	2.6	4.1	2.5
	31	3.0	2.3	3.3	2.5	3.5	2.6	3.6	2.6	3.7	2.6	3.9	2.6	4.1	2.5
	33	3.0	2.3	3.3	2.5	3.5	2.6	3.6	2.6	3.7	2.6	3.9	2.6	4.1	2.5
	35	3.0	2.3	3.3	2.5	3.5	2.6	3.6	2.6	3.7	2.6	3.9	2.6	4.1	2.5
	37	2.9	2.2	3.2	2.4	3.4	2.5	3.5	2.5	3.6	2.5	3.8	2.5	4.0	2.4
	39	2.7	2.1	3.0	2.3	3.2	2.4	3.3	2.4	3.4	2.4	3.6	2.4	3.8	2.3
40	2.7	2.1	2.9	2.2	3.1	2.3	3.2	2.3	3.3	2.3	3.5	2.3	3.7	2.3	
42	2.5	1.9	2.7	2.1	2.9	2.2	3.0	2.2	3.1	2.2	3.3	2.2	3.4	2.1	
44	2.3	1.8	2.5	1.9	2.7	2.0	2.7	2.0	2.8	2.0	3.0	2.0	3.1	1.9	
46	2.0	1.6	2.2	1.7	2.3	1.8	2.4	1.7	2.5	1.7	2.6	1.7	2.8	1.7	



Console Type (MML-AP__4NH-E)

TC : Total capacity [kW] SHC : Sensible capacity [kW]

unit size	outdoor air temp. °CDB	indoor air temp.													
		14°CWB		16°CWB		18°CWB		19°CWB		20°CWB		22°CWB		24°CWB	
		20°CDB	23°CDB	26°CDB	27°CDB	28°CDB	30°CDB	32°CDB	TC	SHC	TC	SHC	TC	SHC	TC
015	10	3.7	2.9	4.1	3.1	4.4	3.3	4.5	3.3	4.6	3.3	4.9	3.3	5.1	3.2
	12	3.7	2.9	4.1	3.1	4.4	3.3	4.5	3.3	4.6	3.3	4.9	3.3	5.1	3.2
	14	3.7	2.9	4.1	3.1	4.4	3.3	4.5	3.3	4.6	3.3	4.9	3.3	5.1	3.2
	16	3.7	2.9	4.1	3.1	4.4	3.3	4.5	3.3	4.6	3.3	4.9	3.3	5.1	3.2
	18	3.7	2.9	4.1	3.1	4.4	3.3	4.5	3.3	4.6	3.3	4.9	3.3	5.1	3.2
	20	3.7	2.9	4.1	3.1	4.4	3.3	4.5	3.3	4.6	3.3	4.9	3.3	5.1	3.2
	21	3.7	2.9	4.1	3.1	4.4	3.3	4.5	3.3	4.6	3.3	4.9	3.3	5.1	3.2
	23	3.7	2.9	4.1	3.1	4.4	3.3	4.5	3.3	4.6	3.3	4.9	3.3	5.1	3.2
	25	3.7	2.9	4.1	3.1	4.4	3.3	4.5	3.3	4.6	3.3	4.9	3.3	5.1	3.2
	27	3.7	2.9	4.1	3.1	4.4	3.3	4.5	3.3	4.6	3.3	4.9	3.3	5.1	3.2
	29	3.7	2.9	4.1	3.1	4.4	3.3	4.5	3.3	4.6	3.3	4.9	3.3	5.1	3.2
	31	3.7	2.9	4.1	3.1	4.4	3.3	4.5	3.3	4.6	3.3	4.9	3.3	5.1	3.2
	33	3.7	2.9	4.1	3.1	4.4	3.3	4.5	3.3	4.6	3.3	4.9	3.3	5.1	3.2
	35	3.7	2.9	4.1	3.1	4.4	3.3	4.5	3.3	4.6	3.3	4.9	3.3	5.1	3.2
	37	3.6	2.8	4.0	3.0	4.2	3.2	4.4	3.2	4.5	3.2	4.8	3.2	5.0	3.1
	39	3.4	2.7	3.8	2.9	4.0	3.1	4.2	3.1	4.3	3.1	4.5	3.0	4.8	3.0
40	3.3	2.6	3.7	2.8	3.9	3.0	4.1	3.0	4.2	3.0	4.4	2.9	4.6	2.9	
42	3.1	2.4	3.4	2.6	3.7	2.8	3.8	2.8	3.9	2.8	4.1	2.7	4.3	2.7	
44	2.8	2.2	3.1	2.4	3.3	2.5	3.4	2.5	3.5	2.5	3.7	2.5	3.9	2.4	
46	2.5	2.0	2.7	2.1	2.9	2.2	3.0	2.2	3.1	2.2	3.3	2.2	3.4	2.1	
018	10	4.6	3.5	5.1	3.7	5.4	3.9	5.6	3.9	5.8	3.9	6.1	3.9	6.4	3.8
	12	4.6	3.5	5.1	3.7	5.4	3.9	5.6	3.9	5.8	3.9	6.1	3.9	6.4	3.8
	14	4.6	3.5	5.1	3.7	5.4	3.9	5.6	3.9	5.8	3.9	6.1	3.9	6.4	3.8
	16	4.6	3.5	5.1	3.7	5.4	3.9	5.6	3.9	5.8	3.9	6.1	3.9	6.4	3.8
	18	4.6	3.5	5.1	3.7	5.4	3.9	5.6	3.9	5.8	3.9	6.1	3.9	6.4	3.8
	20	4.6	3.5	5.1	3.7	5.4	3.9	5.6	3.9	5.8	3.9	6.1	3.9	6.4	3.8
	21	4.6	3.5	5.1	3.7	5.4	3.9	5.6	3.9	5.8	3.9	6.1	3.9	6.4	3.8
	23	4.6	3.5	5.1	3.7	5.4	3.9	5.6	3.9	5.8	3.9	6.1	3.9	6.4	3.8
	25	4.6	3.5	5.1	3.7	5.4	3.9	5.6	3.9	5.8	3.9	6.1	3.9	6.4	3.8
	27	4.6	3.5	5.1	3.7	5.4	3.9	5.6	3.9	5.8	3.9	6.1	3.9	6.4	3.8
	29	4.6	3.5	5.1	3.7	5.4	3.9	5.6	3.9	5.8	3.9	6.1	3.9	6.4	3.8
	31	4.6	3.5	5.1	3.7	5.4	3.9	5.6	3.9	5.8	3.9	6.1	3.9	6.4	3.8
	33	4.6	3.5	5.1	3.7	5.4	3.9	5.6	3.9	5.8	3.9	6.1	3.9	6.4	3.8
	35	4.6	3.5	5.1	3.7	5.4	3.9	5.6	3.9	5.8	3.9	6.1	3.9	6.4	3.8
	37	4.5	3.4	4.9	3.6	5.3	3.8	5.4	3.8	5.6	3.8	5.9	3.7	6.2	3.7
	39	4.3	3.2	4.7	3.4	5.0	3.6	5.2	3.6	5.3	3.6	5.7	3.6	5.9	3.5
40	4.1	3.1	4.6	3.3	4.9	3.5	5.0	3.5	5.2	3.5	5.5	3.5	5.7	3.4	
42	3.8	2.9	4.3	3.1	4.5	3.3	4.7	3.3	4.8	3.3	5.1	3.2	5.3	3.2	
44	3.5	2.6	3.9	2.8	4.1	3.0	4.3	3.0	4.4	3.0	4.6	2.9	4.9	2.9	
46	3.1	2.3	3.4	2.5	3.7	2.6	3.8	2.6	3.9	2.6	4.1	2.6	4.3	2.5	

SMMS-e Engineering Data Book

Model name:

MMY-MAP_6HT8P

MMY-MAP_6HT7P

September, 2015 Full version